

CONVERT YOUR HI-FI AMPLIFIER FOR HIGHER POWER

DECEMBER 1955

# RADIO - ELECTRONICS

TELEVISION • SERVICING • HIGH FIDELITY

HUGO GERNSBACH, Editor

In this issue:

Rainbow Patterns  
with your  
Signal Generator

•  
How to Build a  
Tremolo Circuit

•  
Signal Injection  
with  
Transistor Probe

•  
Make Your Own  
Photoetched  
Circuits

•  
Complete  
1955 Index

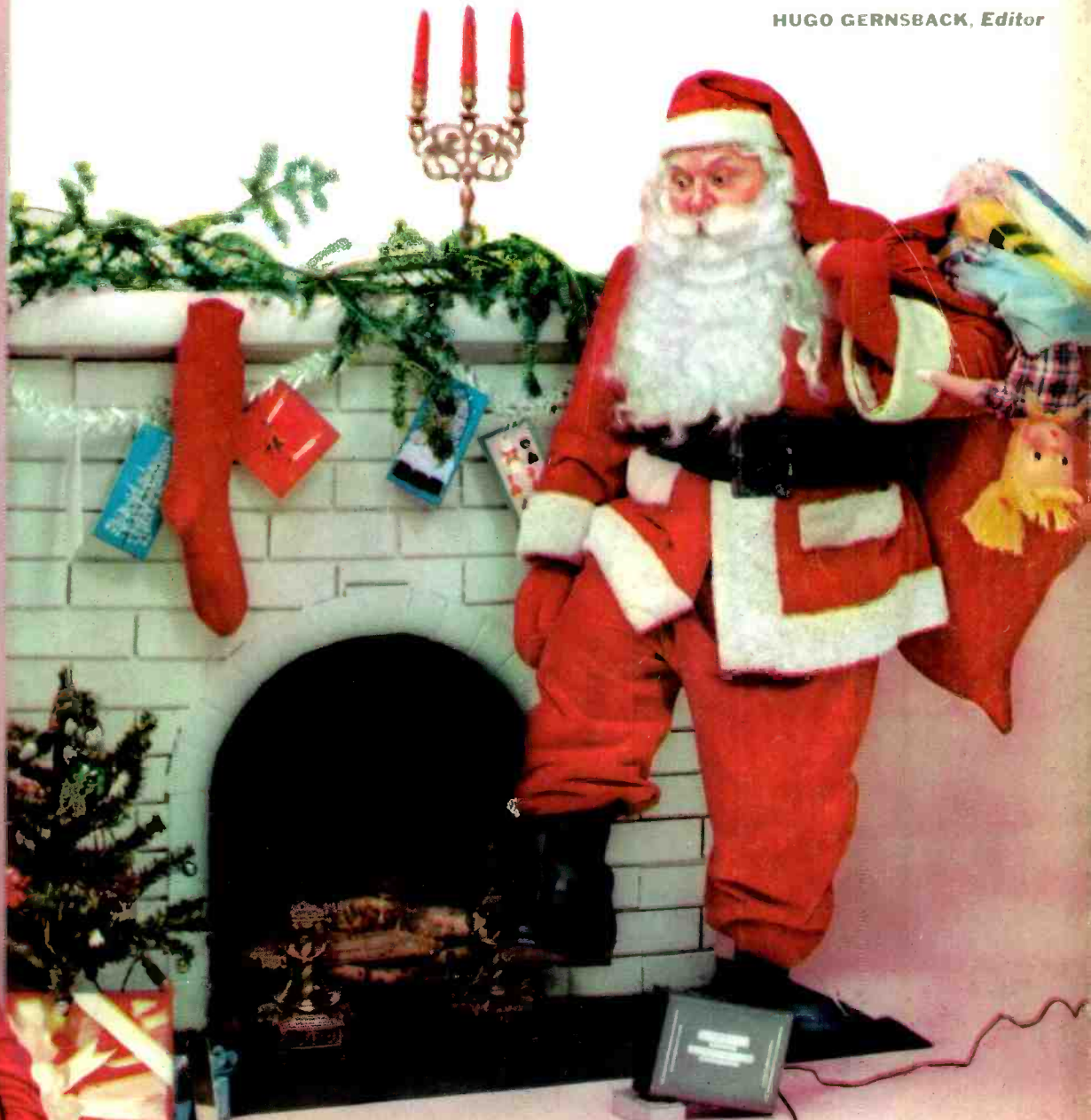

35¢

U. S. and  
CANADA

The

FULTON T V 3-57  
% PAUL S BOLLARO  
434 FULTON ST  
ELIZABETH 1 N J

# you can't match **TRIPIELET** model 630 VOM



**SPEED  
ACCURACY  
DURABILITY  
CONVENIENCE!**

*heavy molded case*  
—1/4" thick for high impact.  
Fully insulated.

*sure grip battery contacts*  
Balanced double-spring tension grip assures permanent contact.

*"this wide-range model*  
tests AC-DC Volts (DC at 20,000 O/V); DC Microamperes, Milliampere, and Amperes; Ohms (to 100 Megohms); Decibel and Output. Its easy-to-read scales are the longest in this type tester."



*streamlined design*  
No protruding knobs on switch or ohms control—both are flush with the panel.

*king size recessed knob*  
—Only one switch; (fully enclosed) selects both circuit and range. Just turn the switch and make your reading.

BURTON BROWNE ADVERTISING



*advanced engineering*  
—Molded mounting for resistors and shunts allow direct connections without cabling. No chance for shorts. Longer life and easy-to-replace resistors in their marked positions.

*for quick positive connections*  
—Banana jacks and plugs on test leads are best. Alligator clips are provided to slip on test prods for extra convenience.

*for convenience in reading*  
—Available as an extra (only 50c), this special stand tilts meter at best angle for easy reading



*for most efficient meter use*  
—With every Model 630 you receive complete, simplified instructions on how to use and maintain most efficiently.

*no slip feature*  
Four rubber feet furnished as standard equipment fit in back of the case to prevent slipping on smooth surfaces.

**TRIPIELET ELECTRICAL INSTRUMENT CO.**  
Bluffton, Ohio

**MODEL 630 | \$39.50**



**THE MIGHTY NINE VOM LINE**

- 631**  
Combination V-O-M—VTVM
- 630-NA**  
For Best Testing Around The Lab, Production Line or Bench
- 630**  
The Popular All-Purpose V-O-M
- 630-A**  
A Good Lab and Production Line V-O-M
- 310**  
The Smallest Complete V-O-M With Switch
- 630-T**  
For Telephone Service
- 666-HH**  
Medium Size For Field Testing
- 625-NA**  
The First V-O-M With 10,000 Ohms/Volt AC
- 666-R**  
Medium Size With 630 Features

An Invitation . . .

# To men who want to "go places" in TV SERVICING

Find out about this NEW,  
ALL-PRACTICE WAY  
of becoming a Professional  
TV SERVICEMAN

If you have some Radio or Television experience, or if you know basic Radio-Television principles but lack experience—NRI's new Professional Television Servicing course can train you to *go places* in TV servicing. This advertisement is your personal invitation to get a free copy of our booklet describing this training in detail.

### Learn-by-Doing "All the Way"

This is 100% learn-by-doing, practical training. We supply *all* components, *all* tubes, *including* a 17-inch picture tube, and comprehensive manuals covering a thorough program of practice. You learn how experts diagnose TV defects quickly. You see how various defects affect receiver performance—picture and sound; learn causes of defects, accurately, easily, and how to fix them. You do more than just build circuits. You get practice recognizing, isolating, and fixing innumerable troubles.

You get actual experience aligning TV receivers, diagnosing the causes of complaints from scope patterns, eliminating interference, using germanium crystals to rectify the TV picture signal, obtaining maximum brightness and definition by properly adjusting the ion trap and centering magnets, etc. There isn't room on this or even several pages of this magazine to list all the servicing experience you get.

### UHF & COLOR TV Making New Boom

Installing front-end channel selector strips in modern UHF-VHF Television receivers and learning UHF servicing problems and their solution is part of the practice you get. To cash in on the coming color TV boom you'll need the kind of foundation in knowledge and experience this training gives.

### Get Details of New Course Free

Once again—if you want to go places in TV servicing, we invite you to find out what you get, what you practice, what you learn from NRI's new course in Professional Television Servicing. See pictures of equipment supplied, read what you practice. Judge for yourself whether this training will further your ambition to reach the top in TV servicing. We believe it will. We believe many of tomorrow's top TV servicemen will be graduates of this training. Mailing the coupon involves no obligation.

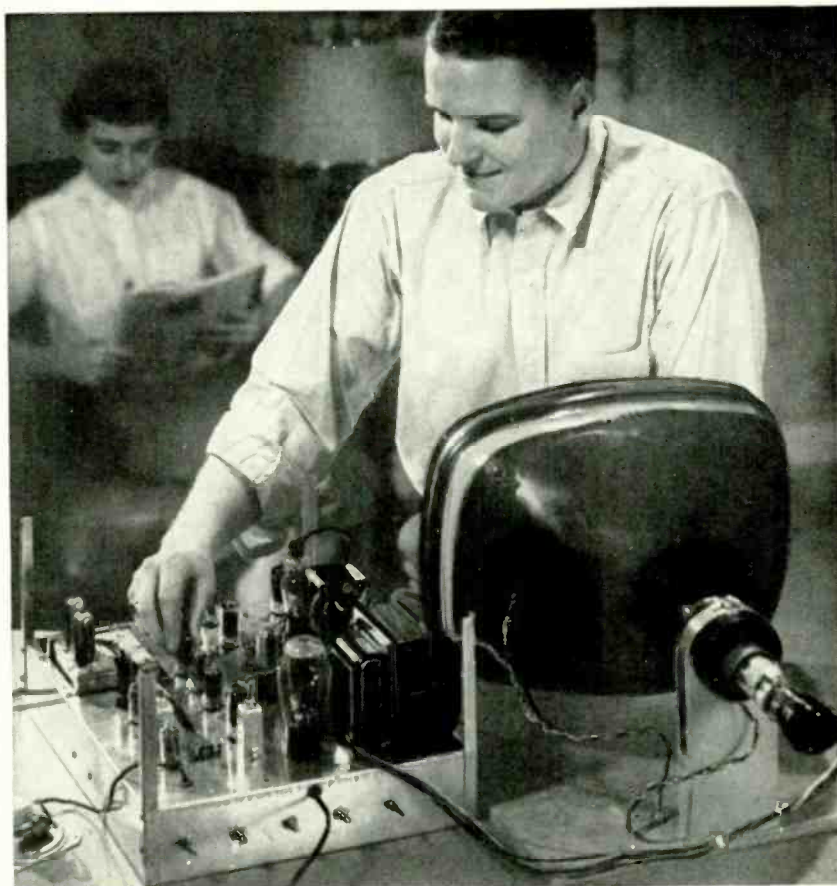

Train at home easily, quickly, for TV's top servicing jobs. NRI's Professional Television Servicing course includes a 17-inch picture tube and all other tubes and components to build a complete TV Receiver, Oscilloscope, Signal Generator, H.F. Probe. Complete training, including all equipment, available now for a low introductory price—under \$200 on easy terms.



National Radio Institute, Dept. 5NFT  
16th and U Sts., N.W., Washington 9, D. C.

Please send my FREE copy of "How to Reach the Top in TV Servicing." I understand no salesman will call.

Name . . . . . Age . . . . .

Address . . . . .

City . . . . . Zone . . . . . State . . . . .

APPROVED MEMBER NATIONAL HOME STUDY COUNCIL

# RADIO - ELECTRONICS

Formerly RADIO CRAFT • Incorporating SHORT WAVE CRAFT • TELEVISION NEWS • RADIO & TELEVISION\*

Hugo Gernsback  
Editor and Publisher  
M. Harvey Gernsback  
Editorial Director  
Fred Shunaman  
Managing Editor  
Robert F. Scott  
W2PWG, Technical Editor  
Jerome Kass  
Associate Editor  
I. Queen  
Editorial Associate  
Matthew Mandl  
Television Consultant  
Elizabeth Stalcup  
Production Manager  
Angie Pascale  
Editorial Production  
Wm. Lyon McLaughlin  
Tech. Illustration Director  
Sol Ehrlich  
Art Director

Lee Robinson  
General Manager  
John J. Lamson  
Sales Manager  
G. Aliquo  
Circulation Manager  
Adam J. Smith  
Director, Newsstand Sales  
Robert Fallath  
Promotion Manager

## GERNSBACK PUBLICATIONS, INC.

Executive, Editorial and Advertising Offices, 25 West Broadway, New York 7, N. Y. Telephone REctor 2-8630.

Hugo Gernsback  
Chairman of the Board  
M. Harvey Gernsback  
President  
G. Aliquo  
Secretary

### ON THE COVER

This month the cover tells its own story. It only goes to show there is no way to trap Santa Claus, even with the best of modern photocell alarms.

Color original by Habershaw Studios, N. Y. C.

Photocell alarm courtesy Terminal Radio Corp., N.Y.C.



Average Paid Circulation over 175,000

## DECEMBER 1955

## Vol. XXVI, No. 12

Annual Index (Pages 150-155)	
Vol. XXVI, January to December, 1955.....	150
Editorial (Page 33)	
Aviation Electronics.....by Hugo Gernsback	33
Electronics (Pages 34-41)	
Cathode-Ray Engine Analyzer.....by C. B. DeHuff	34
Searching for Oil With Electronics.....by James A. McRoberts	37
Transistorized Photocell Alarm.....by Rufus P. Turner	40
Audio—High Fidelity (Pages 42-53)	
High-Power Williamson Amplifier for Hi-Fi.....by David Hafler	42
Sound Selling.....by Robert E. Riddle	44
Remote Transistor Amplifier.....by Edward M. Noll	45
Add a Bias and Erase Indicator to Your Tape Recorder.....by Frank J. DiElsi	46
Tremolo—Where You Want It.....by Tom Jaski	47
For Golden Ears Only: Pilotrol PA-913 preamplifier-equalizer; Miracord XA 100 record changer and XM 110 turntable; new records review.....by Monitor	50
Technical Reports (Pages 54-55)	
What's New.....	54
Radio (Pages 56-62)	
Making Photoetched Circuits in Your Workshop. Part I— Process permits simplified construction; making drawing and negative.....by Richard H. Dorf	56
It's Reactance That Counts.....by H. P. Manly	59
A Transistor D.C. Transformer.....by I. Queen	61
Electrolysis Problem.....by J. Perkinson, Jr.	62
Test Instruments (Pages 63-87)	
Your Receiver as an Audio Generator.....by Fred Lingel	63
The Milvamp.....by Forrest H. Frantz, Sr.	64
Transistor Signal Injector Probe.....by Homer L. Davidson	66
Midget TV Kilovoltmeter.....by Elliott A. McCreedy	79
R-C Controlled Oscillator.....by John W. Straede	80
A 1,000- and 100-cycle Filter.....by James Fred	86
Television (Pages 88-114)	
Service Insurance That Works!.....by Ralph W. Hallows	88
Post-Acceleration Tube.....by Fred Shunaman	90
Watch Your R's and C's.....by H. L. Matsinger	94
Rainbow Patterns With Conventional Generators.....by Robert G. Middleton	96
Those Deadly Intermittents.....by Art Margolis	98
TV Alignment.....by Charles G. Buscombe	102
Troubleshooting the Video Detector.....by James A. McRoberts	106
TV Service Clinic.....Conducted by Jerry Kass	109
Orient Your TV Antenna With a V.T.V.M.....by Louis Bourget	114

### DEPARTMENTS

Annual Index, Vol. XXVI,		Patents.....	129
Jan.-Dec.....	150	People.....	143
Books.....	159	Question Box.....	134
Business.....	146	Radio Month.....	6
Corrections.....	128	Radio-Electronic Circuits.....	131
Correspondence.....	10	Technical Literature.....	157
Miscellany.....	117	Technicians News.....	115
New Devices.....	118	Techniques.....	137
New Tubes and Transistors.....	126	Try This One.....	140

Associate Member of Institute of High Fidelity Mfrs., Inc.

RADIO-ELECTRONICS, December, 1955, Vol. XXVI, No. 12. Published monthly at Mt. Morris, Ill. by Gernsback Publications, Inc. Second-class mail privileges authorized at Mt. Morris, Ill. Copyright 1955 by Gernsback Publications, Inc. Text and illustrations must not be reproduced without permission of copyright owners.

SUBSCRIPTIONS: Address correspondence to Radio-Electronics, Subscription Dept., 404 N. Wesley Ave., Mt. Morris, Ill., or 25 West Broadway, New York 7, N. Y. When ordering a change please furnish an address stencil impression from a recent wrapper. Allow one month for change of address.

SUBSCRIPTION RATES: U. S., U. S. possessions and Canada, \$3.50 for one year; \$6.00 for two years; \$8.00 for three years; single copies 35c. Pan-American countries \$4.00 for one year; \$7.00 for two years; \$9.50 for three years. All other countries \$4.50 a year; \$8.00 for two years; \$11.00 for three years.

BRANCH ADVERTISING OFFICES: Chicago: 7522 North Sheridan Road. Tel. ROgers Park 4-8000. Los Angeles: Ralph W. Harker and Associates, 600 South New Hampshire, Tel. DUnklirk 7-2328. San Francisco: Ralph W. Harker and Associates, 582 Market St., Tel., Garfield 1-2481. FOREIGN AGENTS: Great Britain: Atlas Publishing and Distributing Co., Ltd., London E.C. 4. Australia: McGill's Agency, Melbourne. France: Brenta no's, Paris 2e. Belgium: Arence et Messageries de la Presse, Brussels. Holland: Trilectron, Heemstede. Greece: International Book & News Agency, Athens. So. Africa: Central News Agency Ltd., Johannesburg; Capetown, Durban, Natal. Universal Book Agency, Johannesburg. Middle East: Steimatzy Middle East Agency, Jerusalem. India: Broadway News Centre, Dadar, Bombay #14. Pakistan: Paradise Book Stall, Karachi 3. POSTMASTER: If undeliverable send form 3578 to: RADIO-ELECTRONICS, 25 West Broadway, New York 7, N. Y. \*Trademark registered U. S. Patent Office.



**Get more money!  
More security! More out of life!**



**Learn  
TELEVISION  
• RADIO •  
ELECTRONICS**

**Get the best!**

**Get National Schools' SHOP-METHOD HOME TRAINING!**

Start now! Why wait around for that raise or promotion that may never come? Get started *now* in high-paying TV-Radio-Electronics! National Schools' SHOP METHOD Home Training prepares you for success in a top-salary job or in your own business. You learn *all three*... Television, Radio, Electronics... in one complete course. Our Shop-Tested lessons and manuals help you master all phases in shortest possible time! Send coupon, find out today!

**WHY NATIONAL SCHOOLS LEADS THE FIELD**

Located in the "Television Center" of the world, our staff is in close touch with latest developments and opportunities. We give you personalized job placement assistance. We also give you confidential help with both technical and personal problems relating to your training. We show you how to make Part Time Earnings as you progress. Whether you live 30 miles away, or 3,000, you will always be pleased with our prompt, friendly service!

**DRAFT AGE?** Our home training helps you achieve specialized ratings and higher pay grades if you go in service.

We send you this precision-tested Multitester! Plus parts to build Oscillators, Receivers, Signal Generator, Continuity Checker, Combination Short Wave and Standard

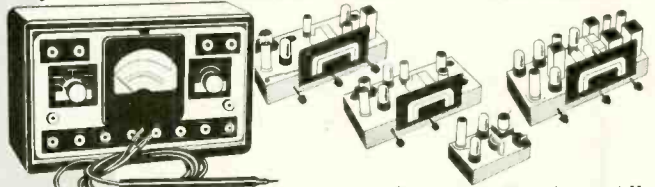

Broadcast Superhet Receiver. All this equipment is part of your National Schools course. **NO EXTRA CHARGES!** Send coupon for free books!

**NATIONAL SCHOOLS,** world-famous technical trade school. Now in our 50th year!



**NATIONAL SCHOOLS**

**TECHNICAL TRADE TRAINING SINCE 1905**

LOS ANGELES 37, California • CHICAGO: 323 West Polk St.

IN CANADA: 811 West Hastings Street, Vancouver, B. C.

• APPROVED FOR G. I. TRAINING

• BOTH HOME STUDY AND RESIDENT COURSES OFFERED

**30 MILLION TV SETS**

need regular repair! Color TV means more sets than ever before. NOW is the golden opportunity to cash in on this multi-billion-dollar industry. Or "write your own ticket" in broadcasting, manufacturing, and other specialized phases!

**YOUR AGE  
IS NO  
OBSTACLE!**



**Send for  
FREE LESSON!  
FREE BOOK & SAMPLE LESSON  
will convince you!  
SEND COUPON TODAY!**

**MAIL NOW TO OFFICE NEAREST YOU!**

(mail in envelope or paste on postal card)

**NATIONAL SCHOOLS, Dept. RG-125**

4000 SOUTH FIGUEROA STREET  
LOS ANGELES 37, CALIFORNIA

OR 323 WEST POLK STREET  
CHICAGO 7, ILLINOIS

Please rush **FREE BOOK**, "My Future in Radio-Television-Electronics," and **FREE LESSON** at once. I understand there is no obligation, and no salesman will call.

NAME \_\_\_\_\_ BIRTHDAY \_\_\_\_\_ 19 \_\_\_\_\_

ADDRESS \_\_\_\_\_

CITY \_\_\_\_\_ ZONE \_\_\_\_\_ STATE \_\_\_\_\_

Check if interested **ONLY** in Resident Training at Los Angeles.

VETERANS: Give date of discharge \_\_\_\_\_

# HERE'S WHAT THEY SAY ABOUT THE SHURE SLIM-X Model "777"

... the most versatile low-cost crystal probe microphone ever made!

## For Remote Broadcasting

"Selected this microphone after comparison with three other makes in the same price class."

*Station Manager, West Virginia\**

## For Public Address

"... it surpasses in fidelity all six of the other microphones we have been using—two of which are dynamic mikes."

*Minister, Washington\**

## For Square Dance Calling

"Callers at square dances favor Shure microphones... I have an order for five SLIM-X Microphones."

*Sound Dealer, Illinois\**

## For Professional Entertainers

"SLIM-X" is ideal... fits so nicely in pocket of dress coat, and performs perfectly... worked with large PA systems up to 100 watts, using different "mics" but your SLIM-X beats them all."

*Performer, Pennsylvania\**

## For Tape Recording

"I used it to record a church service last evening... delighted at the results. I thought I would take a minute out to tell you that you have a very nice looking, nice sounding, and easy-to-use microphone."

*New York\**

## For Ham Transmitting

"... I hit the jackpot with a Shure Model 777 SLIM-X... reports on my sure that any one possessing this microphone is as well pleased with it as I am."

*Radio Amateur, Illinois\**

Use it in the hand, on a desk stand, on a floor stand, around the neck—can be removed in a flash, no matter where you use it. Furnished with stand, mounting cradle and lavalier cord.

MODEL 777 List Price \$21.00

**SHURE** *The Mark of Quality*

**SHURE BROTHERS, INC.**

225 W. Huron St. • Chicago 10, Ill.

\*Names available on request

# the Radio month



**HI-FI AT CARNEGIE HALL** was demonstrated by English sound authority Gilbert A. Briggs, designer and manufacturer of the Wharfedale speaker. Briggs used four of his creations together with Acoustical Quad II amplifiers, a Garrard variable-speed transcription motor, Leak and Ferranti pickups and a large array of other high quality audio equipment.

The show was a followup of a similar successful demonstration in London and featured the playing of records in conjunction with live performances of the same works by the same artists. The conclusion reached by a majority of the audience was that, though recorded music has not yet reached the point where it can rival the live presentation, there were at least a few times during the program that the ear did not immediately detect the changeover from one to the other.

**METAL-CERAMIC TUBE** developed by General Electric is of radically new design and construction. The first of this line, designated as microminiature ceramic tubes, is the 6BY4 triode (technical characteristics are given in the New Tubes section). Other designs will include a series ranging from diodes to multi-element types. The tubes consist of small ceramic and metal layers arranged alternately. The width of these layers is not indicative of the spacing of the internal parts. Interelectrode spacings within the tubes are measured in microns. Size of the tube is almost the same as that of the grid cap on the old 6A7 or 6D6.

The ceramic-metal construction promises successful operation at temperatures far in excess of that obtainable with conventional glass tubes. The parallel-plane layout gives the 6BY4 a considerable improvement in u.h.f. performance over the conventional coaxial construction common in miniature tubes. Major factors in the improved operation of the tube are its low lead inductance and nearly complete isolation of input and output circuits.

**WEATHER PREDICTIONS** can be considerably improved through wider use of radar. According to weather men attending the recent 139th national American Meteorological Society meeting in Asbury Park, N. J., radar and other electronic equipment can be used to forecast flash floods and help track and spot more accurately such severe storms as the recent East Coast hurricanes.

Radar will improve precipitation forecasts because it can show where and how much rain or snow is falling as it falls. This permits warning of possible flash floods. With part of the \$7.5 million especially appropriated by Congress at its last session, the Weather Bureau plans to purchase 40 new radar sets, mostly for installation in the Middle West and along the East Coast. This new radar equipment will have sufficient power to penetrate to the heart of hurricanes, as the set now operating at Cape Hatteras, N. C., proved when it went into operation for the first time this year scanning hurricane Connie.

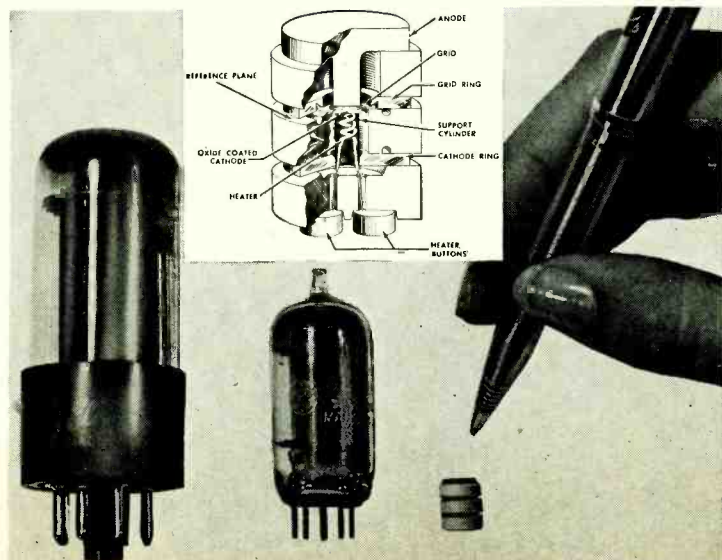

Comparative size of General Electric's microminiature ceramic tube, type 6BY4.

# Here's an amazingly effective way to learn TELEVISION RADIO and ELECTRONICS in spare time AT HOME... or at DTI's big Chicago training center

What will mailing the coupon below do for YOU? First, you will get . . . absolutely free . . . the valuable publication, "89 Ways to Earn Money in Television-Radio-Electronics." You'll find out about scores of exciting, good paying opportunities in this vast, billion-dollar industry—one of the largest, most promising opportunity fields in America today. Best of all, you will find out exactly how you may prepare to get into this good paying work that is so interesting . . . that enables you to start your own business almost "on a shoestring," if you prefer this to a job opportunity.

## NOW . . . get EVERYTHING you need!

You'll also see WHY so many employers ask for DeVry graduates. You'll see that DeVry Tech provides every major training advantage you may need . . . in your spare time at home . . . or in our big million-dollar training center in Chicago. In our home program, you (1) learn-by-reading from easy-to-read, well illustrated lessons, (2) learn-by-seeing from home movies—a wonderful advantage that helps make important points picture clear, and (3) learn-by-doing from 16 shipments of Electronic parts, enabling you to work over 300 fascinating projects.



HOME MOVIES  
VACUUM TUBE  
VOLT-METER

5 INCH  
"SCOPE"  
OSCILLOSCOPE

21 INCH  
Build and keep this BIG DTI  
Engineered TV set—easily  
converted to U.H.F. DTI offers  
another home training, but  
without the TV set!

## Valuable Test Equipment Helps You "Earn While You Learn"

As part of your home laboratory projects, you build and keep a top-quality Vacuum Tube Voltmeter and a 5-inch Oscilloscope—two of the most useful pieces of test equipment. No need to buy this expensive equipment later. Little wonder so many DeVry students tell us they are able to earn all, or a good part of the cost of their training, servicing TV and Radio equipment in their spare time.

## MODERN LABORATORIES

If you prefer, get all your preparation in DeVry's new Chicago training center—one of the finest, best equipped of its kind. Write for details!

## EMPLOYMENT SERVICE

Upon completing your training, you can get the full benefit of the same effective employment service that has already helped thousands of DeVry graduates to start earning good money.

## MILITARY SERVICE

If you are subject to Military service, the information we have should be very helpful to you. Mail coupon today.

## MAIL COUPON TODAY!

**89 WAYS  
TO  
EARN  
MONEY  
IN TELEVISION  
RADIO  
ELECTRONICS**

DeVry Technical Institute  
4141 Delmont Ave., Chicago 41, Ill. Dept. RE-112L

I would like complete facts including  
"89 Ways to Earn Money in Television-  
Radio-Electronics."

Name \_\_\_\_\_ Age \_\_\_\_\_  
PLEASE PRINT  
 Street \_\_\_\_\_ Apt. \_\_\_\_\_  
 City \_\_\_\_\_ Zone \_\_\_\_\_  
 State \_\_\_\_\_

DeVry's Training is available in Canada



**DeVry**  
**TECHNICAL INSTITUTE CHICAGO 41, ILLINOIS**  
 "One of America's Foremost Television Training Centers"  
 Formerly DeFOREST'S TRAINING, INC.

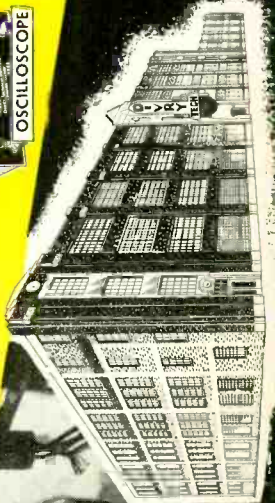

# Audio Powerhouse

**MEETS THE HIGH POWER DESIGN REQUIREMENTS OF HIGH FIDELITY AUDIO AMPLIFIERS**



For outputs up to 100 watts, two 6550's in push-pull will provide the same power now attained in most existing designs by the use of four or more tubes. Reduction in the number of tubes means simplified electrical balance, reduced maintenance and over-all lower cost. With proper circuitry, the 6550 will provide full power output with approximately the same grid voltage drive as the 6L6, 5881 or KT66 types. The 6550 is produced under laboratory conditions with exhaustive quality control to assure premium performance and long life. Ask your tube supplier for it.

TUNG-SOL ELECTRIC Inc., Newark 4, N.J.  
Sales Offices: Atlanta, Chicago, Columbus, Culver City, Dallas, Denver, Detroit, Newark, Seattle

**TUNG-SOL**  
**6550**  
**BEAM POWER AMPLIFIER**

## THE RADIO MONTH

**ELECTRONIC TOLL SYSTEM** has been installed at all toll booths on the new 241-mile superhighway, the Ohio Turnpike. The equipment, recently developed by International Business Machines Corp., consists of a combination of devices that permits weighing all vehicles while they are in motion as they approach the toll booths (see photo).

Operation of the new system is simple and automatic. As each vehicle approaches a toll booth at any one of the turnpike's 17 interchanges, a special weighing treadle built into the traffic lane pavement separately weighs each



axle and a photoelectric detector counts the number of axles. At the same time, the toll collector, having inserted a fare card in the IBM toll recorder, determines by visual inspection the number of axles on the vehicle and depresses a corresponding key on the recorder.

Depression of the proper axle key automatically totals the individual axle weights and the recorder registers the vehicle's classification, along with other information, on the fare card. If the operator presses the wrong axle key, the toll recorder locks to prevent improper validation of the fare card and an indicator on top of the recorder lights up to display the correct axle pattern. The attendant, at a glance, may correct his error by depressing the proper axle key.

A fare card, indicating the amount to be paid for the trip, is given to the driver for presentation at the exit gate with his toll.

**AUDIO ENGINEERING** Society held its seventh annual convention, in conjunction with the Audio Fair, at the Hotel New Yorker (New York City) Oct. 12-15. The fair, held concurrently, started on the 13th and ran through the 16th, giving the assembled engineers an opportunity to study the latest audio products after the sessions ended. Eight sessions were held, during which 47 papers were presented, covering the whole field from properties of magnetic tape to consumer reaction to "high fidelity."

The society's John H. Potts award for outstanding achievement in audio engineering was given to Dr. Lee de Forest for his invention of the thermionic amplifier tube; detector, amplifier

(Continued)

and oscillator circuits; for improvements in sound motion pictures. The Audio Engineering Society award for service to the society was presented to Norman C. Pickering of the company bearing his name. Honorary memberships were also bestowed on Prof. Leo Beranek, author of *Acoustics* and less recently of *Acoustic Measurements*, as well as on Dean W. L. Everitt of the University of Illinois for his work in electronics and the writing and editing of technical books.

More than 30,000 people flocked to see more than 175 exhibits at Audio Show, despite heavy rains and floods which inundated New York City and cut off whole sections of the country to the north and east. A most noticeable feature was the new electrostatic high- and middle-range speakers presented by Janszen and Pickering. The greatly increased participation of foreign firms and especially foreign products was also remarked on. Both Telefunken and Blaupunkt, large German audio manufacturers, were exhibitors, and products of other foreign manufacturers, notably German and British, were exhibited by their American representatives. Asia was represented by exhibitor Matsushita Electric of Japan, with speakers and portable radios.

**SEVEN NEW TV STATIONS** have gone on the air since our last report:

WITN	Washington, N. C.	7
KBMB-TV	Bismarck, N. D.	12
WOSU-TV	Columbus, Ohio	34
WORA-TV	Mayaguez, P. R.	5
KDLO-TV	Florence, S. D.	3
WDBJ-TV	Roanoke, Va.	7
WHTN-TV	Huntington, W. Va.	13

Canada's 29th station, CKVR-TV, Barrie, Ont., channel 3, has gone on the air.

**RADIO TOWER AND LABORATORY**, built at Alpine, N. J. by the late Maj. Edwin H. Armstrong in 1938 to perfect frequency-modulated radio transmission, has been acquired from Armstrong's estate by Columbia University for its School of Engineering. It will be known as the Edwin H. Armstrong Field Laboratory and will be used for research in radiation and propagation of various types of waves.

**1,000-MC TRANSISTOR** was announced recently by Paul Galvin, president of Motorola, Inc. The transistor is to be made by semi-automatic methods at a new plant in Phoenix, Ariz., and will be produced in volume in 1 or 2 years.

The transistor is a "diffused-base" type, originally developed by Bell Laboratories. To produce it, a slab of germanium is placed in a controlled atmosphere containing impurities (bismuth or arsenic) in gaseous form. By applying heat, these impurities can be made to penetrate the germanium in controlled quantities. This system, according to Motorola scientists, is a much simpler way of adding the "donor" impurities to the germanium than present methods, and greatly reduces the number of rejects. **END**



Current Revision-Just Off The Press!

# FREE

There's  
**MONEY  
FOR YOU**  
IN 2-WAY MOBILE  
RADIO SERVICING  
Booklet

PLAN NOW FOR A **BIGGER INCOME** in 1956

**SERVICING 2-WAY MOBILE RADIO SYSTEMS PAYS BIG MONEY**

Get Your FCC  
COMMERCIAL RADIO OPERATOR  
**LICENSE**  
IN A MINIMUM OF TIME!

Get These  
Amazing  
Booklets  
**FREE**

Money-Making  
FCC  
Commercial Radio  
Operator  
**LICENSE**  
Information

How to Pass

**FCC**

ANIMATIONS

**TELLS HOW**

**WE GUARANTEE**  
TO TRAIN AND COACH YOU AT HOME  
IN SPARE TIME UNTIL YOU GET  
**YOUR FCC LICENSE**

**TELLS HOW**

Employers Make Job Of-  
fers To Our Graduates  
Every Month In Practic-  
ally Every Field Of Radio!

NATIONAL MANUFACTURER of Mobile Com-  
munications Equipment has several openings in  
the Southwest for FCC licensed, experienced  
technicians in the field of 2-way Radio Mobile  
Communications. Salary commensurate with ex-  
perience and ability.

TECHNICIANS: Wanted by nationally known  
Airlines at Washington, D. C. office, in all phases  
of aircraft and ground radio maintenance and  
troubleshooting. Starting salary \$340 per month  
with automatic advancement under present wage  
scale. 1st or 2nd class license required.

DECEMBER, 1955

**TV ENGINEERING**  
Included in Our  
Training and Coaching

**TELLS HOW** Our Amazingly Effective **JOB FINDING**  
**SERVICE** Helps **CIRE** Students Get Better Jobs.

**GETS 2-WAY MOBILE  
RADIO JOB**

"After receiving my 1st class  
phone license and looking over  
several jobs on your Job-Oppor-  
tunities Bulletin, have decided  
on one with Transcontinental Gas  
Pipe Line Corp."

James Driver,  
6419 Fitzhugh Avenue,  
Richmond, Virginia

**GETS AIRLINE JOB**

"Many thanks for your assistance  
in obtaining employment. I am  
now working for United Air-  
lines."

Charles P. Krause,  
4026 W. 57th Place,  
Chicago 29, Illinois

**GETS LABORATORY JOB**

"I am happy to tell you that I  
have obtained a job at Collins Ra-  
dio Company as a senior laboratory  
assistant, and I wish to thank you  
for the assistance you gave me in  
obtaining this job."

James M. Schoening,  
1300 Oakland Road, N. E.,  
Apt. 1308, Cedar Rapids, Iowa

Get All 3  
Booklets Free  
**MAIL  
COUPON  
NOW**



**Cleveland Institute of Radio Electronics**  
4900 Euclid Avenue, Desk RE-83, Cleveland 3, Ohio  
(Address to Desk No. to Avoid Delay)

I want to know how I can get my FCC ticket in a minimum  
of time. Send me your FREE booklet, "How To Pass FCC  
License Examinations" (does not cover exams for Am-  
ateur License), as well as a Sample FCC-type lesson and  
the amazing new booklets, "Money-Making FCC License  
Information" and "There's Money For You in 2-Way  
Mobile Radio Servicing". Be sure to tell me about your  
Television Engineering Course.  
Please Print Clearly

NAME ..... AGE.....

ADDRESS .....

CITY ..... ZONE ..... STATE.....

**FOR PROMPT RESULTS SEND AIR MAIL**  
Special tuition rates to members of the U. S. Armed  
Forces, Electronic Training Available to Canadian Residents.

New  
**HICKOK**

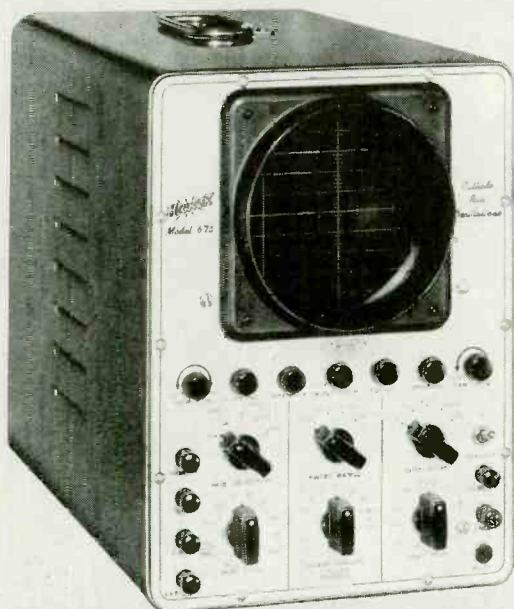

**MODEL 675**  
**WIDE BAND**

*Response at*

**H I G H**

**S E N S I T I V I T Y**

**Flat Frequency Response Through 3.58MC Color Burst  
 Less Than 3db Down at 4.5MC**

A very recent HICKOK engineering achievement  
 eliminates necessity for dual sensitivity.

Moderately priced . . . High quality . . . Ask for a  
 demonstration today!

**THE HICKOK ELECTRICAL INSTRUMENT COMPANY**

10531 Dupont Avenue • Cleveland 8, Ohio

Correspondence

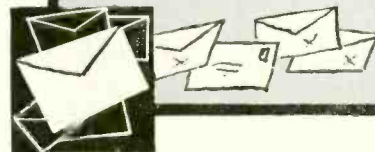

**LOWTHER-VOIGT  
 "CONFUSION"**

*Dear Editor:*

With reference to the letter from D. M. Chave in your July issue, Mr. Chave is correct in stating that confusion exists in mentioning the name of P. G. A. H. Voigt in connection with the development of the Lowther driver. For those who read Mr. Augspurger's words carefully however, there was no confusion at all. He gave Mr. Voigt the credit for the design of the Voigt corner horn and did *not* convey the idea that Mr. Voigt's pioneering work had had any influence on the design of the Lowther driver.

The confusion is of Mr. Chave's own making for he now tells us, in connection with what is surely a most vital part of the driver, namely the diaphragm, that "the Voigt patent of the twin cone had already expired when we developed our P.M. 2 diaphragm. . . ." Those words give only a tiny fraction of the whole story, for it is within my personal knowledge that Lowther has long been making Voigt twin diaphragms.

In prewar days when Mr. Lowther himself owned Lowther, the Lowther-Voigt combination was the Rolls Royce of British hi-fi—Lowther making tuners and amplifiers, Voigt the speakers. Just when Voigt Patents Ltd. first had Lowther make diaphragms for them was never publicized, but the information I have from most reliable sources is that it was in the 1946-47 period when impaired health limited Mr. Voigt's activities. At that time the Lowther Manufacturing Co. (owned by Mr. Chave) and Voigt Patents Ltd. must still have been working in close harmony, for at the annual radio show in 1947 Lowther-Voigt products were featured on the Lowther stand. Three years later, in 1950, Lowther advertised in *Wireless World* illustrating the P.M. 2 driver and describing it as being fitted with a Voigt diaphragm.

Nowadays, the name Voigt does not appear on the label of the Lowther driver, but it is my opinion that Mr. Voigt's methods and teachings have been faithfully incorporated.

Now I, and I am sure, the readers of RADIO-ELECTRONICS, are always glad to give credit to those pioneers and inventors who have done so much for progress in general and hi-fi in particular. Mr. Voigt's invention of the twin diaphragm for extending the upper frequency range of moving-coil

# WHAT

# have you got

# that other

# TV-Radio servicemen

# haven't got?



When you are a *Raytheon Bonded Electronic Technician*, the answer is simple. You have the exclusive tool, the *only* tool in the industry that creates customer confidence — *draws customers to your shop.*

Under the Raytheon Bonding plan, your work and parts guarantee is backed by a Bond issued through one of America's largest insurance companies. Customers appreciate the value of this extra protection and, all else being equal, give their business to the Raytheon Bonded Dealer.

If you can qualify for the Raytheon Bond, it won't cost you a penny. Call your Sponsoring Raytheon Tube Distributor today for the whole story.



**RAYTHEON MANUFACTURING COMPANY**

Receiving and Cathode Ray Tube Operations  
Newton, Mass., Chicago, Ill., Atlanta, Ga., Los Angeles, Calif.

RAYTHEON MAKES ALL THESE:

RECEIVING AND PICTURE TUBES • RELIABLE SUBMINIATURE AND MINIATURE TUBES • SEMICONDUCTOR DIODES, POWER RECTIFIERS AND TRANSISTORS • NUCLEONIC TUBES • MICROWAVE TUBES

loudspeakers is surely one of the neatest tricks in hi fi.

Mr. Augspurger described the Lowther P.M. 2 as "fabulous" when used with a suitable horn load. I am certain about one reason for the outstanding performance—when Mr. Voigt taught Lowther how to make diaphragms, he did the job thoroughly and they have not forgotten what they learned.

L. T. A. BECKETT

Burlington, Ontario

### DAMPING FACTOR

Dear Editor:

As the one originally responsible for introducing the term "damping factor" I feel some responsibility for finding an alternative form now that we are so deeply in the morass. The term had many shortcomings but it could be used safely so long as it was always finite and positive. The commercial release of amplifiers with negative damping factors has been very confusing to engineers, to say nothing of the general public. For an increase of 22% in total circuit damping, the "damping factor" increases from 10 to infinity, then returns back from -infinity to -10. All these extraordinary changes in the damping factor would lead one to believe that something important was happening. In reality nothing has happened except a slight and steady increase in the total damping. The tricks played by the so-called damping factor are due merely to an unfortunate choice of definition. With this definition, instability occurs when the damping factor  $\leq -1$ .

The total circuit damping is a function of the total circuit resistance, that is, the algebraic sum of the voice coil resistance (always positive) and the amplifier output resistance (positive or negative). I therefore put forward the following as a much more satisfactory and logical substitute for damping factor:

$$\text{Damping ratio} = \frac{R_L}{R_L + R_o}$$

where  $R_L$  = load resistance;  $R_o$  = output resistance of amplifier and where both  $R_L$  and  $R_o$  are referred to the same side of the transformer.

The following table is for  $R_L = 15$  ohms and is purely as an example:

$R_o$ ohms	$R_L + R_o$ ohms	Damping factor $= R_L / R_o$	Damping ratio $= R_L / (R_L + R_o)$
+75	+90	+0.2	0.167
+3	+18	+5	0.83
+1.5	+16.5	+10	0.91
+0.15	+15.15	+100	0.97
+0	+15.0	$\infty$	1.0
-0.15	+14.85	-100	1.01
-1.5	+13.5	-10	1.11
-3.0	+10.0	-3	1.5
-12.0	+3.0	-1.25	5.9
-13.6	+1.4	-1.1	10.7
-14.3	+0.7	-1.05	21.4
-15.0	0	-1.0	$\infty$

(on verge of instability)

It will be seen that the proposed damping ratio is positive and finite so long as instability does not occur. It is also proportional to the actual damping in the circuit. It appears to be the only

Slender, modern dynamic at a fraction of the price you expect

**ANOTHER TURNER MICROPHONE VALUE**



**TURNER MODEL 57 DYNAMIC**

FOR BROADCAST, TV, PA

Response: 50 - 13000 c.p.s.  
Level: -55 db

Impedance: wired for quick selection of either high or low.

Cable: 20 ft. 3-conductor shielded with Cannon XL-4 quick-disconnect plug.

Case: black-satin finish. Can't reflect light.

Mounting: hinged coupler swings mike in 60° arc. Standard 5/8" - 27 thread.

Sharp, clear, clean-cut reproduction of voice and music. Quickly converts from desk to floor stand or hand use.

**LIST PRICE: \$57.00**

Model BL-6 Shockmounted matching desk stand: \$7.50



**THE TURNER COMPANY**

933 17th St. NE, Cedar Rapids, Iowa

Canada: Canadian Marconi Co., Toronto, Ont. & Branches

Export: Ad Auriema, Inc., 89 Broad St., New York 4, N. Y.

WITH NEW **irish** BRAND **Double-Play** RECORDING TAPE

**DOUBLE YOUR PLAYING TIME**



**One 7" Reel of New irish Double-Play Tape Has As Much Playing Time - 2400 Feet - As Two 7" Reels of Ordinary Tape!**

2400' on standard 7" reel.....\$7.50 Hi-Fi Net

If not available at your dealer, order direct from:

**RADIO INDUSTRIES, INC.**

Opelika 1, Alabama

World's Largest Exclusive Magnetic Tape Manufacturer

Export: Morhan Exporting Corp., N.Y.C.  
Canada: Atlas Radio Corp., Ltd., Toronto



**Double-Play** the newest of the irish Ferro-Sheen process premium tapes is made on DuPont's strong, tough, miracle film—Mylar. A 7" reel gives you 2 hours of continuous recording at 3 3/4 ips (4 hours dual track). Recommended for all applications requiring long, uninterrupted operation and where tape tension is not excessive.

Send for FREE booklet and get the

# BIG PAYOFF

in **RADIO-TV-ELECTRONICS**

What would a \$10 or \$20 a week raise mean to you?

Think of it! Only one \$10-a-week raise will repay your investment in CREI training, and leave you a profit of \$200 or more the very first year! Your increases in pay thereafter are all pure profit, and you'll be prepared for many more promotions and pay raises in the future years of your life!



**CASH IN ON THE BIG PAYOFF!**

Why let opportunity to make big money pass you by because of lack of training? This booklet describes in detail how CREI training equips you quickly at home to forge ahead into a good paying job—in TV (color, too)—industrial communications—research—aeronautics and scores of other fields in this mushrooming industry.

**CREI Training Means Promotion, Pay Increases Within a Short Time**

Here are just a few letters received from CREI students:

"In this time of less than two years, I have almost doubled my salary and have gone from wireman to engineering assistant and now to junior engineer. I have CREI to thank."—Frank A. Eckert, 22 Clover Lane, Levittown, Pa.

"I chose CREI training upon recommendation of two top engineers. Before I completed the course I became transmitter chief of a 5KW station. I am now employed as a technician at a 100 KW TV station and in spare time have a good TV sales and service business."—Arlie D. Patton, 203 Burke Ave., San Antonio, Tex.

**CREI TEACHES YOU WHAT INDUSTRY WANTS**

Industry recognizes this, by choosing and paying CREI to train their own technical staffs. Among them: United Air Lines, Canadian Broadcasting Corporation, Sears, Roebuck & Co., Bendix Products Division, All America Cable and Radio, Inc., Radio Corporation of America.

**CREI GRADUATES GET TOP JOBS**

... as electronic engineering technicians. Employers contact us regularly for graduates to fill good jobs. Our placement bureau cannot keep

up with the demands. Typical recent requests: "Openings will occur in the GS-10 grade, starting salary \$5500 per year, for men who can qualify for the servicing of 35 mm. motion picture sound and projection equipment. Although some previous experience in this field is desirable, it is not essential if the individual has sufficient training in radio..."—Departments of the Army and Air Force, St. Louis, Mo.

"Just about four months have passed since I made my first recruiting trip to CREI. As a result of that visit Messrs. Kohs, Plante and Wenger are now members of the Laboratories and Mr. Kresge soon will be... we have some openings now and will have others..."—Bell Telephone Laboratories, Murray Hill, N. J.

**NAME YOUR GOAL!**

CREI training equips you to pass FCC exams, qualify for top jobs; or, start your own business—many a graduate has been

launched on a successful, self-owned business career, thanks to CREI training.

**CREI ALSO OFFERS RESIDENCE TRAINING**

CREI Residence School in Washington offers instruction at same high technical level. Classes start frequently. Qualified residence school graduates earn degree: Associate in Applied Science. Check coupon if you prefer residence study.

**WHY WAIT? YOU CAN'T LOSE!**

You already have practical experience. Add to it CREI's advanced training and be assured of excellent pay, a bright future and job security in all electronics fields.

You owe it to yourself! Fill out coupon and mail today. No obligation. You'll receive your copy of "Your Future in the New World of Electronics" right away—free. Send for it today!

**AVAILABLE TO VETERANS UNDER GI BILL!**

**FILL OUT AND MAIL TODAY—BEFORE YOU FORGET IT!**

**CAPITOL RADIO ENGINEERING INSTITUTE**

Accredited Technical Institute Curricula      Founded 1927

Dept. 1412-B, 3224—16th St., N.W., Washington 10, D. C.

Please send me your course outline and FREE illustrated Booklet "Your Future in the New World of Electronics" ... describing opportunities and CREI home study courses in Practical Electronics Engineering.

- CHECK FIELD OF GREATEST INTEREST
- Practical Radio Electronics Engineering
  - Broadcast Radio Engineering (AM, FM, TV)
  - Practical Television Engineering
  - Aeronautical Electronics Engineering

Name \_\_\_\_\_  
 Street \_\_\_\_\_  
 City \_\_\_\_\_ Zone \_\_\_\_\_ State \_\_\_\_\_  
 CHECK:  Home Study  Residence School  Korean Veteran

To help us answer your request intelligently, please give the following information:

EMPLOYED BY \_\_\_\_\_  
 TYPE OF PRESENT WORK \_\_\_\_\_  
 SCHOOL BACKGROUND \_\_\_\_\_  
 ELECTRONICS EXPERIENCE \_\_\_\_\_  
 IN WHAT BRANCH OF ELECTRONICS ARE YOU MOST INTERESTED? \_\_\_\_\_

# WIN-TRONIX

## Makes Sweep and Sync Circuit Trouble-Shooting Easy! LOW-COST DYNAMIC SWEEP CIRCUIT ANALYZER

for  
Black-and-White TV  
and color too!  
only

**\$69.95**  
dealer net



Model 820

TWO  
INSTRUMENTS  
IN ONE

1. Horizontal and vertical sawtooth-square wave and sync pulse generator.
2. Complete compatible flyback and yoke tester.

### ISOLATE SWEEP/SYNC TROUBLES RAPIDLY IN FIVE EASY STEPS!!!

1. VERTICAL TROUBLESHOOTING  
Inject 60 cps on vertical output grid from "vertical grid drive" jack.



2. HORIZONTAL TROUBLESHOOTING  
Inject 15,734 cps on horizontal output grid from "horizontal grid drive" jack.



3. HORIZONTAL TROUBLESHOOTING  
Drive horizontal output xfmr directly from "xfmr drive" jack.



4. COMPONENT TESTING  
Test flyback transformer and deflection yoke in receiver with Model 820.

5. SYNC CIRCUIT TROUBLESHOOTING  
Inject vertical and horizontal sync pulses, stage by stage, in sync amplifiers, with accessory probes.

SPECIFICATIONS  
Signal Outputs  
15,734 cps sawtooth and pulse adjustable.  
15,734 square wave adjustable.  
60 cps sawtooth locked to line.  
Overload indicator for safety and test.  
Oscillating neon indicator with D.C. amplifier for flyback/yoke test.  
Calibrated for color and black-and-white.  
Test leads supplied.  
Operates on 105-125 VAC.

### OTHER WIN-TRONIX LOW-COST TV TEST INSTRUMENTS— Buy Now for Bl. & Wh. Service—be ready for color!

WHITE DOT—Linearity  
Generator



Model  
160

**\$79.95**

RAINBOW GENERATOR



Model  
150

Patent Pending **\$49.95**

COMPATIBLE FIELD  
STRENGTH METER



Model  
330

**\$129.95**

FLYBACK AND YOKE  
TESTER

Model  
810



**\$29.95**

- Compatible advanced design prevents obsolescence!
- Low cost with high quality!
- Portability!
- Standard warranty on all instruments!

SEE YOUR PARTS JOBBER!  
WRITE FOR FREE LITERATURE!

COMPATIBLE CRYSTAL  
CALIBRATOR



Model  
120

**\$59.95**

## WINSTON ELECTRONICS, INC.

RE-1255 4312 Main St., Philadelphia 27, Pa.

CORRESPONDENCE (Continued)  
available function with all the desired qualities.

F. LANGFORD-SMITH  
Amalgamated Wireless Valve Co.  
Sydney, N. S. W., Australia

### McINTOSH MC-30 AMPLIFIER

Dear Editor:

I wish to extend sincere thanks from McIntosh Laboratory for the excellent article (August) covering our MC-30 amplifier.

There are several technical comments I wish to offer. Let me say, however, that these comments are not intended to in any way deprecate the article. To the best of my knowledge it is 100% correct.

Regarding the 1614's in the output stage, they do approach class-B operation. However they do not operate into grid current as one might expect, except on peaks when the amplifier is operated above the rated 30-watt level. The 12AX7 cathode follower is used to not only handle these peaks, but primarily to provide a relatively low d.c. impedance to ground for the 1614 control grids. This low impedance is necessary to prevent a change in bias for the 1614 tubes due to reverse grid current. Such a bias change can cause excessive plate and screen dissipation in the output tubes.

Regarding the 12BH7 load resistor connection, the a.c. load impedance presented to the plates of the 12BH7 is greatly increased above the 12,000-ohm value of the resistors used, as you mentioned. This impedance is four times that, or 48,000 ohms.

SIDNEY A. CORDERMAN  
Chief Engineer

McIntosh Laboratory, Inc.  
Binghamton, N. Y.

### DIFFERENCE OF OPINION

Dear Editor:

That was a nice write-up in the August issue, page 47, for the Cabinart Rebel V. However, I would point out one difference of opinion. The third paragraph states, "There is some fundamental response below that (0 cycles) which can be accentuated with bass boost in the amplifier." Actually the cutoff is closer to 90 cycles and accentuation merely raises the distortion.

It is extremely unfortunate that amplifiers, once equalized for record turnover, tape response or other pre-emphasis, can not be "locked up." I know we couldn't sell an amplifier without a lot of knobs—the more knobs the more sales—but it is as wrong as a \$3 bill to play any of them other than flat. I have no tone controls on my demonstration equipment. The only knob is volume!

To boost the bass level to attempt to compensate for lack of bass range in a speaker puts a "hump" just above cutoff and likely adds distortion to the resulting boomy quality.

PAUL W. KLIPSCH  
Klipsch & Associates  
Hope, Ark.

END

# free

## 1956 VALUE PACKED ALLIED

### 324-PAGE ELECTRONIC SUPPLY CATALOG

send for it today

Get ALLIED's 1956 Catalog—it's *complete*, up-to-date—324 pages packed with the world's largest selection of quality electronic equipment at lowest, money-saving prices. Select from the latest in High Fidelity systems and components; P.A. systems and accessories; recorders and supplies; TV tubes, antennas and accessories; Amateur receivers, transmitters and station gear; specialized industrial electronic equipment; test instruments; new build-your-own kits; huge listings of parts, tubes, transistors, tools, books—the world's *most complete* stocks of quality equipment. Get *every* buying advantage at ALLIED: fastest shipment, expert personal help, lowest prices, assured satisfaction. Send today for your FREE copy of the big 1956 ALLIED Catalog.



### World's Largest Stocks

- All TV & Radio Parts
- All Electron Tube Types
- Test & Lab Instruments
- High Fidelity Equipment
- Latest Build-Your-Own Kits
- Recorders & Supplies
- P.A. Systems, Accessories
- Amateur Station Gear
- TV Antennas, Accessories
- Tools and Books
- Equipment for Industry

## ALLIED RADIO

World's Largest Electronic Supply House

### EASY-PAY TERMS

Use our liberal Easy Payment Plan—only 10% down, 12 months to pay—no carrying charges if you pay in 60 days. Available on Hi-Fi and P.A. units, recorders, TV chassis, test instruments, kits, Amateur gear, etc.

### HI-FI SPECIALISTS

To keep up with the latest and best in High Fidelity, look to ALLIED. Count on us for *all* the latest releases and largest stocks of Hi-Fi equipment. We specialize, too, in TV supply—and are foremost in the field of Builders' Kits.

ultra-modern facilities for the FASTEST SERVICE IN ELECTRONIC SUPPLY



the only COMPLETE catalog for everything in TV, Radio, Hi-Fi and Industrial Electronics

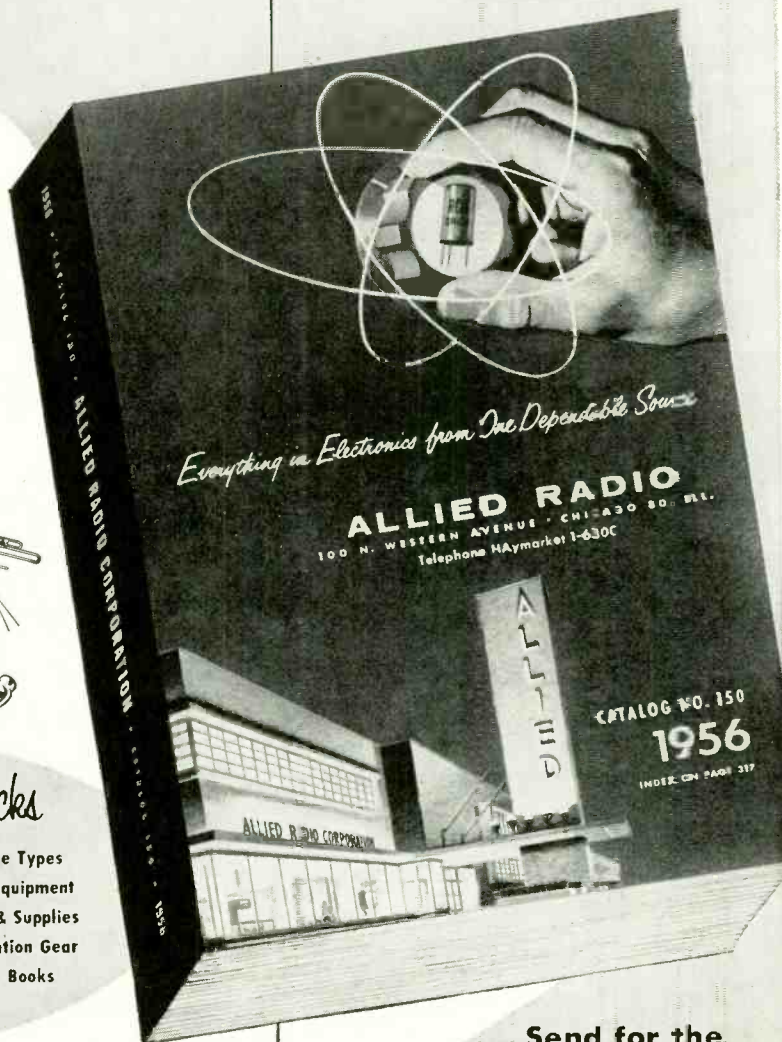

Send for the leading Electronic Supply Guide

# free

ALLIED RADIO CORP., Dept. 2-M-5  
100 N. Western Ave., Chicago 80, Illinois

Send FREE 324-Page 1956 ALLIED Catalog

Name .....

Address .....

City ..... Zone ..... State .....

# The "K.O." is Fantastic!

Features the highest front-to-back ratios ever recorded for any TV antenna:

- **Low band:** from 20:1 to 50:1 relative VOLTAGE.
  - **High band:** Up to 13:1 relative VOLTAGE.
- High gain:** Low band, 7 to 9 DB. High band, 8.5 to 10.5 DB. (Single bay figures). Balanced for COLOR.

**Ends co-channel interference!**  
**Knocks out "Venetian Blinds"!**

Channel Masters "K.O." puts an INVISIBLE BARRIER in the path of rear signals, preventing co-channel interference. The "K.O." is completely preassembled with time-saving "Snap-Lock" Action. 100% aluminum.

LICENSED BY KAY-TOWNES ANTENNA CO., ROME, GA.

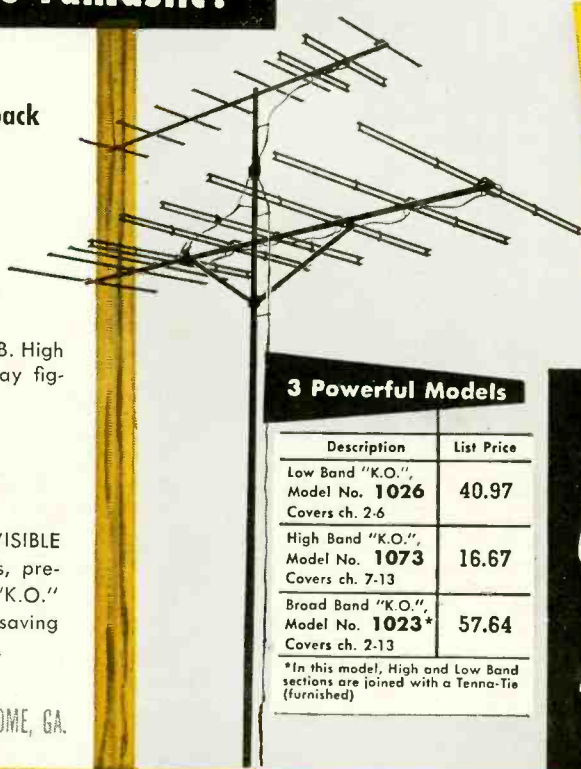

### 3 Powerful Models

Description	List Price
Low Band "K.O.", Model No. 1026 Covers ch. 2-6	40.97
High Band "K.O.", Model No. 1073 Covers ch. 7-13	16.67
Broad Band "K.O.", Model No. 1023* Covers ch. 2-13	57.64

\*In this model, High and Low Band sections are joined with a Tenna-Tie (furnished)

**New Antennas!**

**New Accessories!**

**CHANNEL MASTER**  
**now provides you**

# The <sup>new</sup> Super Fan

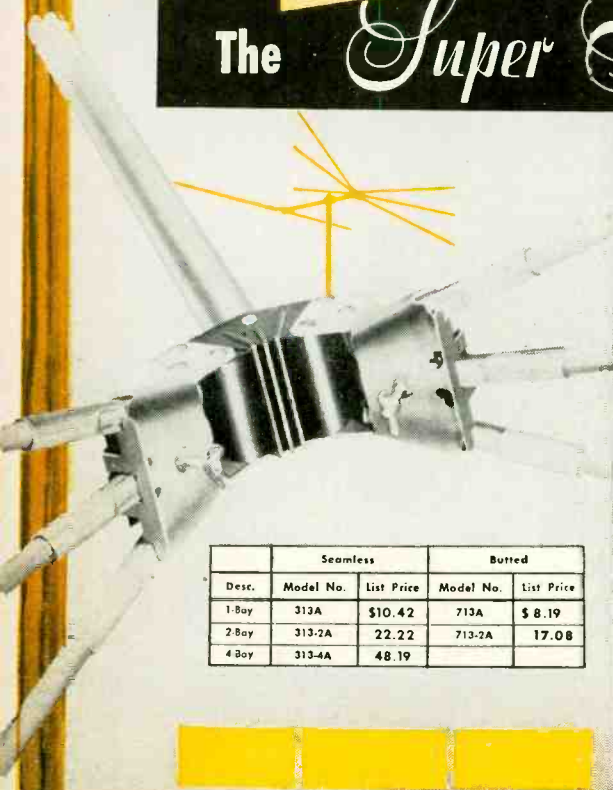

- "Super-Sembled"!
- Re-designed!
- Better than ever!

Channel Master's Super Fan is the original fan antenna. Famous for its superb quality, it has been in continuous demand for six years. Millions are in current use.

- Assembles with NO HARDWARE or tightening.
- Massive, heavy-duty, molded fan head. Unaffected by moisture and extreme temperatures.
- Reinforced elements. External sleeves prevent breakage.

Desc.	Seamless		Butted	
	Model No.	List Price	Model No.	List Price
1-Bay	313A	\$10.42	713A	\$ 8.19
2-Bay	313-2A	22.22	713-2A	17.08
4-Bay	313-4A	48.19		



**CHANNEL MASTER CORP.** ELLENVILLE, N. Y.

the world's largest manufacturer of television antennas and accessories



# CHANNEL MASTER'S

new

## TV TRANSMISSION LINE

The first TV wire to give you the benefits of

**20** strands per conductor (20/33 pure copper).



it's got  
**FLEX-APPEAL!**



Channel Master wire — at REGULAR prices — is the finest, most flexible transmission line you have ever handled. Complete range of web thicknesses available. Colorful display packaging.

with  
**EVERYTHING**  
but the roof!

### Two outstanding lines:

(both featuring exclusive 20-strand conductor):

#### "TWIN TWENTY"

- Marked every 10 feet. Saves time, ends waste.
- Full width. Available in silver or brown.
- Pure VIRGIN polyethylene.

#### "CHALLENGER"

Fine quality transmission line at today's VERY LOWEST PRICES.

installation. From now on, guarantee customer satisfaction with a **COMPLETE CHANNEL MASTER INSTALLATION — FROM TOP TO BOTTOM.**

new

## STANDOUT insulators

Featuring this revolutionary new **2 in 1** screw thread design!

Eliminates the need for stocking separate machine and wood screws. Cuts your inventory investment in standoffs by more than 65%.

- Needle sharp point, made possible by finer thread. Easier to work in wood. Prevents slipping on mast.
- STANDOUT buckle has 8 machined threads.
- Convenient "Taper-Tip" strapping, available in galvanized or stainless steel.

It's a wood screw insulator

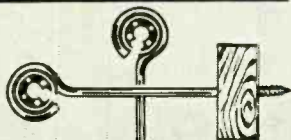

It's a machine screw insulator

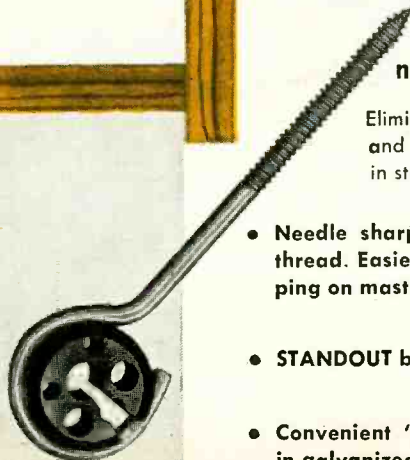

All popular types and sizes available, including full assortment of specialized hardware. See your Channel Master distributor

Copyright 1955, Channel Master Corp.

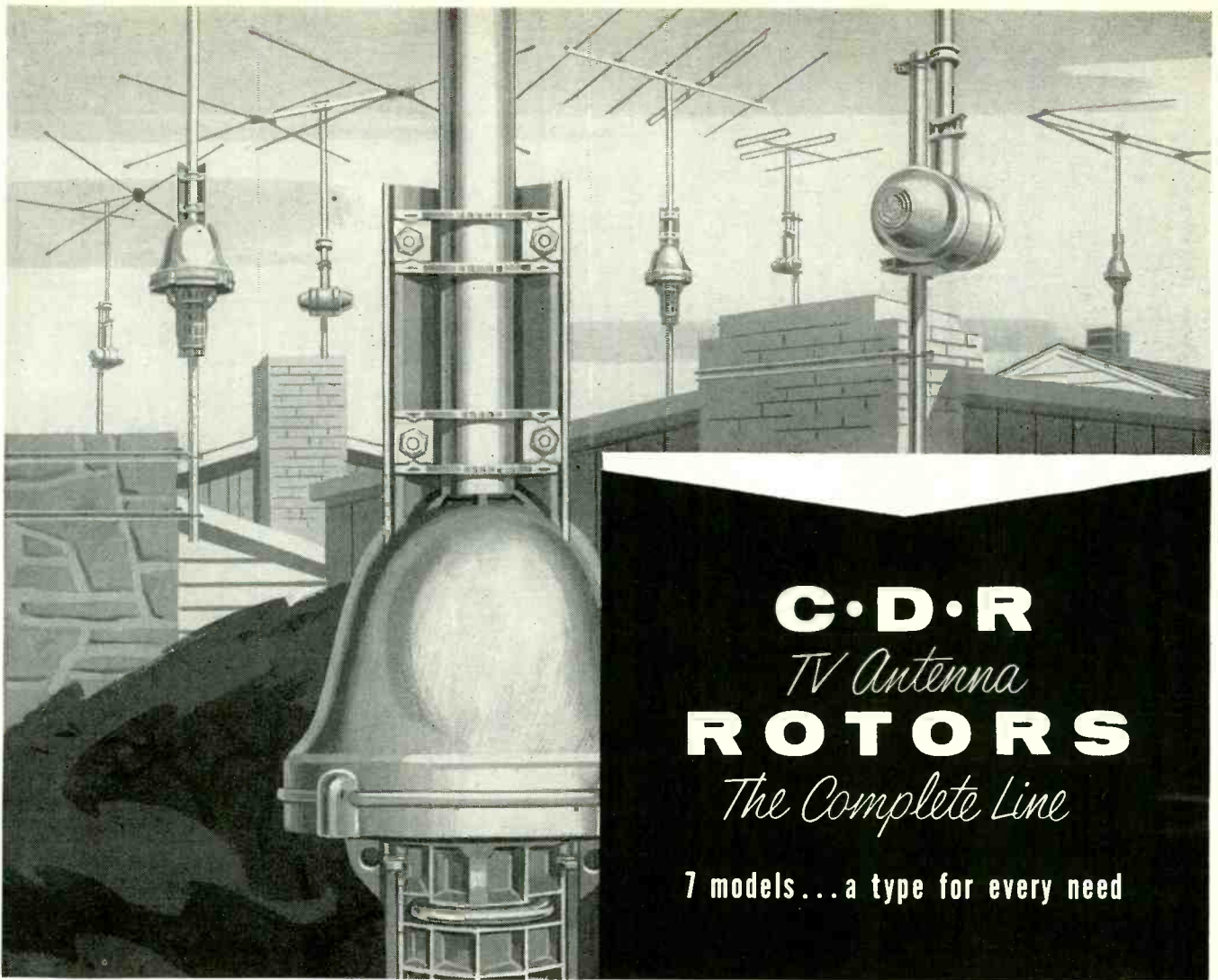

**C·D·R**  
*TV Antenna*  
**ROTORS**  
*The Complete Line*

7 models... a type for every need

featuring **C·D·R automatic ROTORS**

Here they are . . . the fastest selling line of rotors . . . complete in every detail . . . including three models in completely AUTOMATIC rotors! The AR-1 and AR-2 and the AR-22 which is the automatic version of the famous TR-2. ALL FIELD TESTED AND PROVEN BY THOUSANDS OF SATISFIED USERS!

**TR-2** The heavy duty rotor with plastic cabinet featuring "compass control" illuminated perfect pattern dial . . . uses 8 wire cable.

**TR-12** Complete rotor INCLUDING thrust bearing. Handsome modern cabinet with meter control dial, uses 4 wire cable.

**TR-4** The heavy duty rotor complete with handsome new, modern cabinet with METER control dial, uses 4 wire cable.

**TR-11** Same as model TR-12 without thrust bearing.

pre-sold

PRE-SOLD to millions with the greatest concentration of TV Spots in our history.



**CORNELL-DUBILIER**  
 SOUTH PLAINFIELD, N. J.



**THE RADIART CORP.**  
 CLEVELAND 13, OHIO

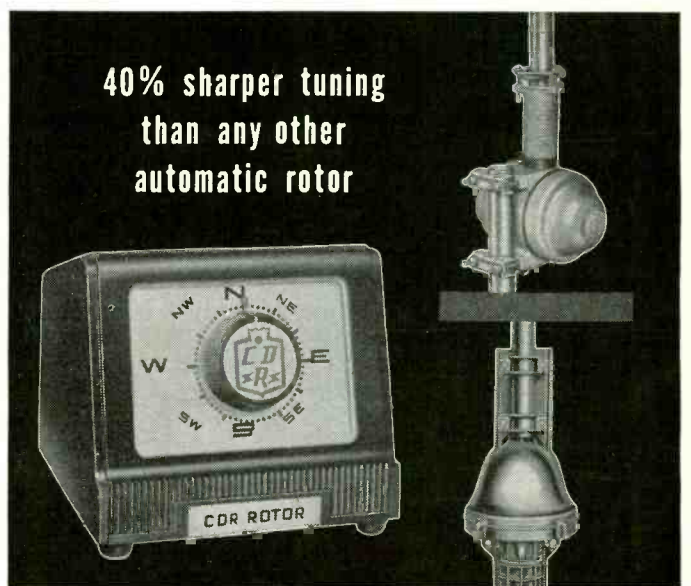

40% sharper tuning  
 than any other  
 automatic rotor

# I Will Train You at Home

## For Good Pay Jobs, Success in

# RADIO-TELEVISION

**J. E. SMITH**  
 President  
 National Radio  
 Institute  
 Washington, D. C.  
 40 years of success  
 training men at  
 home in spare time.



**I'll Prove It Is Easy And  
 Practical To Learn At Home.  
 Sample Lesson FREE.**



**To See Equipment I Send You  
 For Practical Experience...  
 Get Illustrated Book FREE.**



## Practice Broadcasting with Equipment I Send

It's practical to train at home for good Radio-TV jobs and a brighter future. As part of my Communications Course I send you kits of parts to build the low-power Broadcasting Transmitter shown at the left. You use it to get practical experience performing procedures demanded of Broadcasting Station Operators. An FCC Commercial Operator's License can be your ticket to a better job and a bright future; my Communications Course gives you the training you need to get your license. Mail card below and see in my book other valuable equipment you build. Get **FREE** sample lesson.

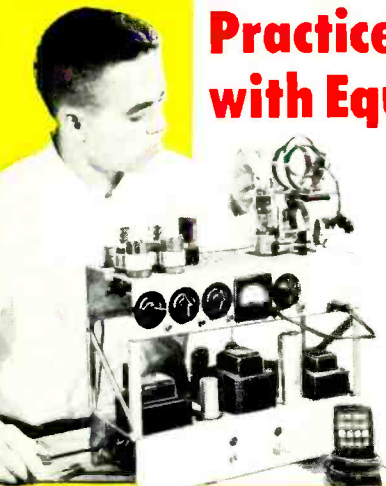

## Practice Servicing with Equipment I Send

Self-confidence, security, earning power come from knowing-how and from experience. Nothing takes the place of **PRACTICAL EXPERIENCE**. That's why NRI training is based on **LEARNING BY DOING**. You use parts I furnish to build many circuits common to Radio and Television. With my Servicing Course you build a modern Radio (shown at right). You build a Multitester, use it in conducting experiments, fixing sets in spare time starting a few months after enrolling. All equipment is yours to keep. Card below will bring book showing other equipment you build. Judge for yourself whether you can learn at home in your spare time.



## Television Is Growing Fast Making New Jobs, Prosperity

More than 30 million homes now have Television sets and thousands more are being sold every week. Well trained men are needed to make, install, service TV sets and to operate hundreds of Television stations. Think of the good job opportunities here for qualified technicians, operators, etc. If you're looking for opportunity, get started now learning Radio-Television at home in spare time. Cut out and mail postage-free card. J. E. Smith, President, National Radio Institute, Washington, D. C. Over 40 years' experience training men at home.

**AVAILABLE TO  
 VETERANS  
 UNDER G.I. BILL**

**Good Jobs  
 Good Pay See Other Side**

**Get My SAMPLE LESSON and  
 64-Page Illustrated Book  
 BOTH FREE**

**Cut out and mail  
 card NOW!**

This card entitles you to Actual Lesson on Servicing, shows how you learn Radio-Television at home. You'll also receive my 64-page Book, "How to Be a Success in Radio-Television." Mail card now!

**NO STAMP NEEDED! WE PAY POSTAGE**

**Mr. J. E. SMITH, President  
 National Radio Institute, Washington 9, D. C.**

Mail me Lesson and Book, "How to Be a Success in Radio-Television." (No Salesman will call. Please write plainly.)

NAME.....AGE.....

ADDRESS.....

CITY.....ZONE.....STATE.....

**VETS** write in date of discharge.....

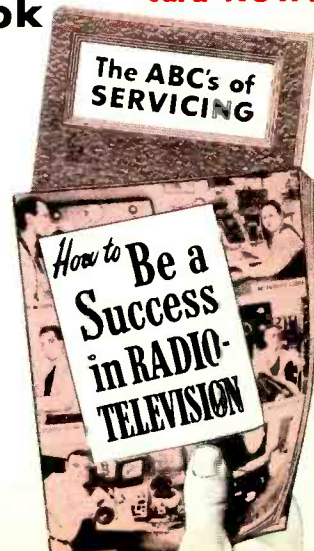

# Train at Home to Jump Your Pay as a RADIO-TV Technician



J. E. Smith, President  
National Radio Institute

The men whose messages are published below were not born successful. Not so long ago they were doing exactly as you are now... reading my ad! They decided they should KNOW MORE... so they could EARN MORE... so they acted! Mail card below now.

## Get a Better Job—Be Ready for a Brighter Future in America's Fast Growing Industry

Training PLUS opportunity is the PERFECT COMBINATION for job security, good pay, advancement. When times are good, the trained man makes the BETTER PAY, GETS PROMOTED. When jobs are scarce, the trained man enjoys GREATER SECURITY. NRI training can help assure more of the better things of life.

Radio-Television is today's opportunity field. Even without Television, Radio is bigger than ever before. Over 3,000 Radio Broadcasting Stations on the air; more than 115 million home and Automobile Radios are in use. Television Broadcast Stations extend from coast to coast now with over 30 million Television sets already in use. Over 400 Television stations are on the air and there are channels for hundreds more.

Use of Aviation and Police Radio, Micro-Wave Relay, Two-way Radio communication for buses, taxis, trucks, etc., is expanding. New uses for Radio-Television principles coming in Industry, Government, Communications and Homes.

### My Training Is Up-to-Date You Learn by Doing

Get the benefit of our 40 years' experience training men. My well-illustrated lessons give you the basic principles you must have to assure continued success. Skillfully developed kits of parts I furnish "bring to life" the principles you learn from my lessons. Read more about equipment you get on other side of this page.

More and more Television information is being added to my courses. The equipment I furnish students gives experience on circuits common to BOTH Radio and Television.

### Find Out About this Tested Way to Better Pay

Read at the right how fellows who acted to get the better things of life are making out now. Read how NRI students earn \$10, \$15 a week extra fixing Radios in spare time starting soon after enrolling. Read how my graduates start their own businesses. Then take the next step—mail card below.

You take absolutely no risk. I even pay postage. I want to put an Actual Lesson in your hands to prove NRI home training is practical, thorough. I want you to see my 64-page book, "How to Be a Success in Radio-Television," because it tells you about my 40 years of training men and important facts about present and future Radio-Television job opportunities. You can take NRI training for as little as \$5 a month. Many graduates make more than the total cost of my training in two weeks. Mailing postage-free card can be an important step in becoming successful. J. E. Smith, President, National Radio Institute, Washington 9, D. C. Training Men for Over 40 years. Approved Member, National Home Study Council.

## I TRAINED THESE MEN



### Lots of Spare-Time Jobs

"I do a lot of spare-time Radio and TV servicing. It was fun learning and I don't know how to thank you." B. Goede, Plainview, Minn.



### Now TV Trouble Shooter

"I had only gone to 7th grade when I started course. Now have job as TV trouble shooter, also fix sets spare time." M. R. Lindemuth, Fort Wayne, Ind.



### Engineer with WHPE

"Thanks to NRI, I operated a successful Radio repair store. Then I got a job with WPAQ and now am an engineer for WHPE." V. W. Workman, High Point, N. C.



### NRI Course Can't Be Beat

"Am with WCOC. NRI Course can't be beat. No trouble passing 1st class Radiophone license examination." Jesse W. Parker, Meridian, Mississippi.



### Quit Job for Own Business

"I decided to quit my job and do TV work full time. I love my work and am doing all right financially." William F. Kline, Cincinnati, Ohio.



### Extra Money in Spare Time

"I am a police captain and also have good spare-time service business. Just opened my new showrooms and shop." C. W. Lewis, Pensacola, Fla.

Start Soon to Make \$10 to \$15 a Week Extra Fixing Sets



Keep your job while training. Many NRI students make \$10, \$15 and more a week extra fixing neighbors' Radios in spare time, starting a few months after enrolling. The day you enroll I start sending you special booklets that show you how to fix sets. The multimeter you build with parts I furnish helps discover and correct troubles.

SEE OTHER SIDE

## My Training Leads to Jobs Like These

- BROADCASTING:** Chief Technician, Chief Operator, Power Monitor, Recording Operator, Remote Control Operator.
- SERVICING:** Home and Auto Radios, P.A. Systems, Television Receivers, Electronic Controls, FM Radios.
- IN RADIO PLANTS:** Design Assistant, Transmitter Design Technician, Service Manager, Tester, Serviceman, Research Assistant.
- SHIP AND HARBOR RADIO:** Chief Operator, Assistant Operator, Radiotelephone Operator.
- GOVERNMENT RADIO:** Operator in Army, Navy, Marine Corps, Coast Guard, Forestry Service Dispatcher, Airways Radio Operator.
- AVIATION RADIO:** Plane Radio Operator, Transmitter Technician, Receiver Technician, Airport Transmitter Operator.
- TELEVISION:** Pick-Up Operator, Voice Transmitter Operator, Television Technician, Remote Control Operator, Service and Maintenance Technician.
- POLICE RADIO:** Transmitter Operator, Receiver Serviceman.

FIRST CLASS  
Permit No. 20-R  
(Sec. 34.9, P. L. & R.)  
Washington, D. C.

BUSINESS REPLY CARD  
No Postage Stamp Necessary If Mailed In The United States

POSTAGE WILL BE PAID BY  
NATIONAL RADIO INSTITUTE  
16th and U Sts., N. W.  
Washington 9, D. C.

K L M O P R S

SAMPLE LESSON  
and 64-Page BOOK  
BOTH FREE  
CUT OUT AND MAIL  
POSTAGE-FREE CARD

## Have Your Own Business

Many NRI trained men start their own successful Radio-Television sales and service business with capital earned in spare time. Joe Travers, a graduate of mine, in Asbury Park, N. J., writes: "I've come a long way in Radio and Television since graduating. Have my own business on Main Street."



# Garry Moore

NOW SELLING

CBS TUBES ON THE

CBS TELEVISION

NETWORK

“Women! . . . bless 'em, catch on to good things fast. So I'm telling them on my Friday morning show . . . **there are no better tubes made than CBS tubes . . . the tubes with the Good Housekeeping Guaranty Seal.** More and more women will be asking you for CBS tubes.”

*Garry Moore*



Be sure YOU have  
CBS tubes in your tube caddy.

“I'll be on the CBS Television Network selling CBS tubes and your expert service every other Friday, 10:30 to 10:45 a.m., E.S.T.”

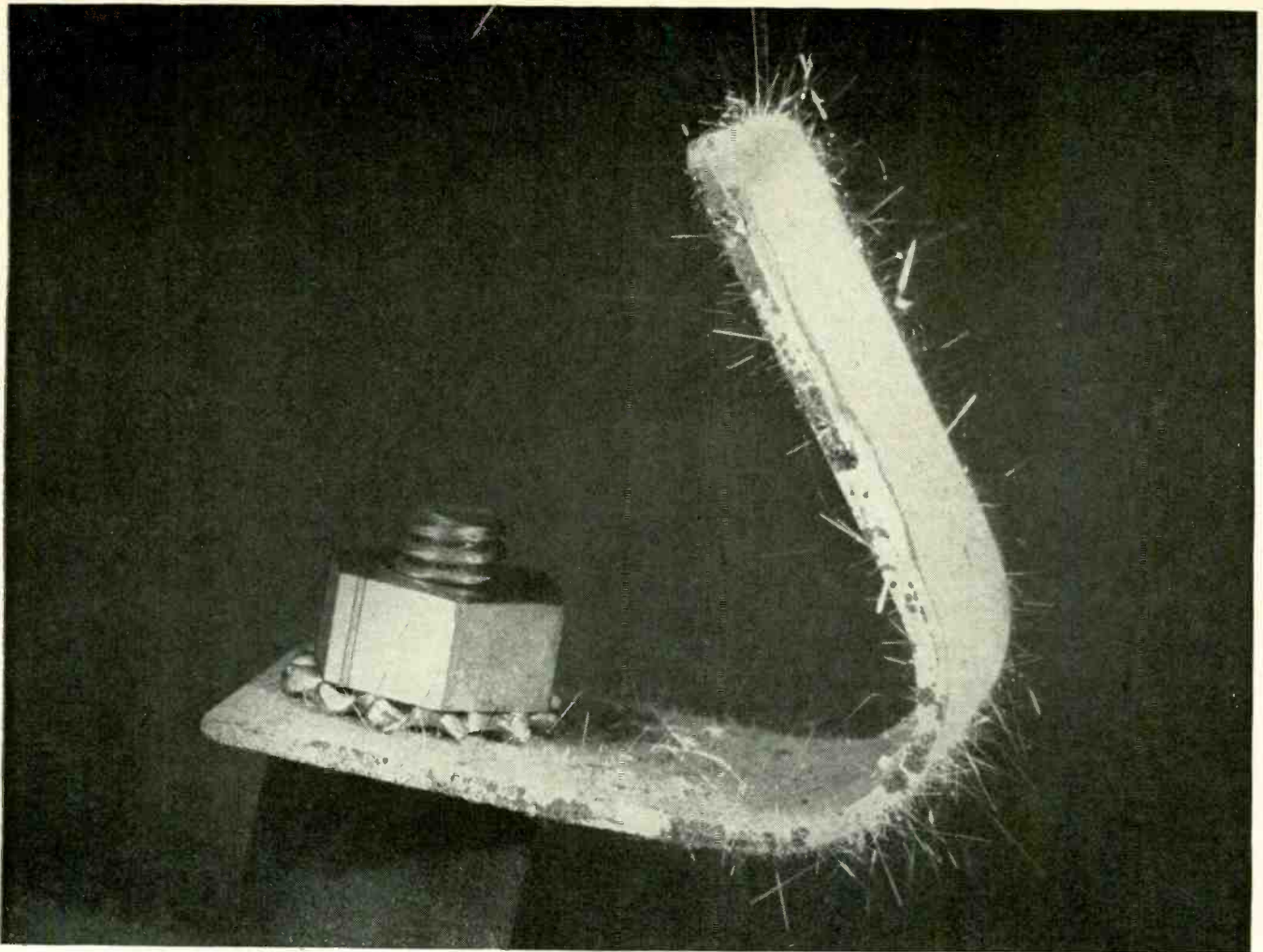

*Whiskers on tin-plated steel, enlarged 6 times. Immense yield strength of metals in whisker form was discovered by Bell scientists.*

## The clue of the metal whiskers

The habit of close observation at Bell Laboratories often turns "tremendous trifles" into important scientific progress. Such a case occurred when unexplained short circuits in wave filters seemed to be associated with a zinc-plated mounting bracket.

Close scrutiny disclosed a whiskery growth on the zinc plating. Similar whiskers of tin were found growing on tin-plated equipment. Studies showed the whiskers to be tiny single crystals of metal.

Suspecting that these unusual crystals might be of essentially perfect structure, alert Laboratories scientists saw an opportunity at last to test

an important metallurgical theory.

The scientists studied the whiskers, grew larger ones, and showed that the crystals had enormously high yield strength as predicted by the theory for perfect crystals—a strength far greater than for the same metal in any other known form. This clue has opened new frontiers in the study of what makes metals strong or weak, and has excited metallurgists all over the world.

Thus, another new advance has come out of the Bell Telephone Laboratories practice of scrutinizing everything that can play a part in better telephone service.

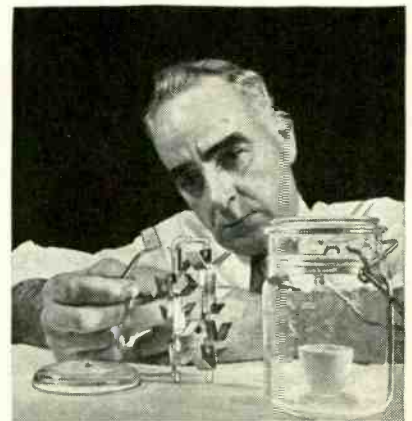

*Through the study of thousands of specially cultivated whiskers, Bell scientists seek to prevent treacherous growths in telephone equipment.*

**BELL TELEPHONE LABORATORIES**

IMPROVING TELEPHONE SERVICE FOR AMERICA PROVIDES CAREERS FOR CREATIVE MEN IN SCIENTIFIC AND TECHNICAL FIELDS



RADIO-ELECTRONICS

# THEY SAID HE COULDN'T LEARN TV AT HOME



... but now he repairs their sets

Read this letter from one of my students — It can help YOU!



L. C. Lane, B.S., M.A.  
President, Radio-Television Training Association.  
Executive Director, Pierce School of Radio & Television.

**I CAN DO FOR YOU WHAT I DID FOR THIS MAN!**

YOU can get top pay in the fast-growing Television-Radio-Electronics field just as this man did. My easily understood lessons — especially prepared for home study — can bring you the same success they brought hundreds of men, many of them with no more than grammar school training.

"Dear Mr. Lane:  
"How to begin this letter, I don't really know, I can never begin to tell you how happy I am with the outcome of your Radio and Television course. I'll never regret clipping your ad out and sending it to you. Believe me, it has changed my whole outlook on life. I believe this is the beginning of a bright new future for me, thanks to RTTA.  
"Already I have established a small reputation in our city and I am looking to the very near future when I go into the radio and TV repair business full time. The last few months I've come very close to doubling my weekly income with very little time spent at it.  
"Now it is my turn to laugh at the people who said I was wasting my time, that I couldn't learn anything through the mail. I've repaired television sets for some of these people and they admit that they were wrong.  
"I look back now just a short year and remember how I stayed up many a night after midnight studying and experimenting. At the same time I was wondering whether something would really come of it. Now I can proudly say it did. Because I reached out and grasped the opportunity RTTA gave me. For that I'll be forever grateful."  
A. F. Duschl, Lancaster, Pa. 1 24 55

## LEARN BY DOING



You work with actual parts and equipment I send you as part of your course. You get enough equipment to set up your own home laboratory and prepare for a top-pay TV job. You build and keep an Electromagnetic TV RECEIVER designed and engineered to take any size picture tube up to

21-inch. (10-inch tube furnished. Slight extra cost for larger sizes.) ... Also a Super-Het Radio Receiver, AF-RF Signal Generator, Combination Voltmeter-Ammeter-Ohmmeter, C-W Telephone Transmitter, Public Address System, AC-DC Power Supply. Everything supplied, including all tubes.

### FCC COACHING COURSE

Important for BETTER-PAY JOBS requiring FCC license. You get this training AT NO EXTRA COST! Top jobs go to FCC-licensed technicians.

### CHOOSE FROM THREE COMPLETE COURSES

covering all phases of Radio, FM and TV

RADIO-FM-TELEVISION TECHNICIAN COURSE — no previous experience necessary.

FM-TV TECHNICIAN COURSE — previous training or experience in radio required.

TV CAMERAMAN AND STUDIO TECHNICIAN COURSE — advanced training for men with Radio or TV training or experience.

### EXTRA TRAINING IN NEW YORK CITY AT NO EXTRA COST!

After you complete either the Radio-FM-TV Technician or the FM-TV Technician course you get two weeks of Lab work on modern electronic equipment at our associate resident school in New York City, Pierce School of Radio & Television. Available if you want it—AT NO EXTRA COST WHATSOEVER!

### FREE



I'll send you my new 40-page book, "How to Make Money in Television, Radio, Electronics," a Free sample lesson, and other literature showing how and where you can get a top-pay job in Television.

## VETERANS

My school fully approved to train Veterans under new Korean G.I. Bill. Don't lose your school benefits by waiting too long. Write discharge date on coupon.

### MAIL THIS COUPON TODAY!

Mr. Leonard C. Lane, President  
RADIO-TELEVISION TRAINING ASSOCIATION  
Dept. R-12C, 52 East 19th Street, New York 3, N. Y.

Dear Mr. Lane: Mail me your NEW FREE BOOK, FREE SAMPLE LESSON, and FREE aids that will show me how I can make BIG MONEY IN TELEVISION. I understand I am under no obligation and no salesman will call.

(PLEASE PRINT PLAINLY)

Name \_\_\_\_\_ Age \_\_\_\_\_  
Address \_\_\_\_\_  
City \_\_\_\_\_ Zone \_\_\_\_\_ State \_\_\_\_\_

- I AM INTERESTED IN:
- Radio-FM-TV Technician Course
  - FM-TV Technician Course
  - TV Cameraman & Studio Technician Course

**VETERANS!**  
Write discharge date

# Radio Television Training Association

52 EAST 19th STREET • NEW YORK 3, N. Y.

Licensed by the State of New York • Approved for Veteran Training

DECEMBER, 1955

**NO SALESMAN WILL CALL!**

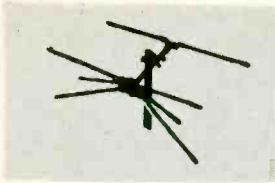

**TELCO SCOUT 3 ANTENNA**

Eight elements; for low channels.  
No. A-180 NET \$3.30

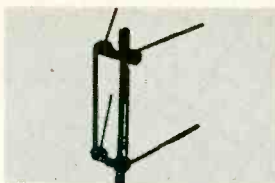

**TELCO DOUBLE V ANTENNA**

Adjustable UHF & VHF... Channels 2-83.  
No. A-9010 NET \$3.75

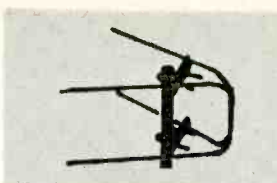

**TELCO U-TYPE DOUBLE V ANTENNA**

Adjusts to any V angle; VHF-UHF.  
No. A-9017 NET \$3.57



**TELCO DOUBLE V WINDOW-TENNA**

UHF-VHF; mounts on window frame.  
No. A-9057 NET \$5.37



**TELCO STAND-OFF "EYE-OPENER"**

Handy tool for faster installing.  
No. 8450 NET \$0.75

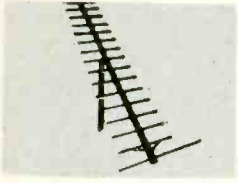

**TELCO UHF GOLDEN YAGI**

16-element style, cut to channel.  
No. A-325 NET \$4.92

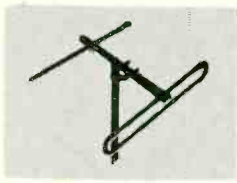

**TELCO HI-LOW DIPOLE ANTENNA**

Pre-assembled; VHF chs. 2-13.  
No. A-250 NET \$5.22

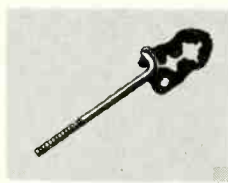

**TELCO E-Z STAND-OFF**

UHF-VHF; 3 1/2" machine screw.  
EZ-8031 NET \$4.80/C

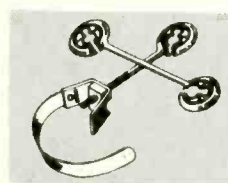

**TELCO E-Z KANT-STRIP STAND-OFF**

7 1/2" 3-way; 9" stainless strap.  
EZ-8396 NET \$0.33

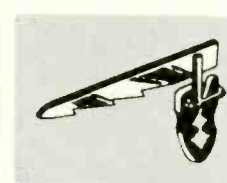

**TELCO E-Z DRIVE-IN STAND-OFF**

Hardened metal 3 1/2" drive.  
EZ-8751 NET \$0.15

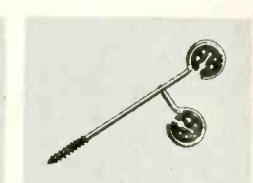

**TELCO DUPLEX STAND-OFF**

7 1/2" in-line duplex wood screw.  
No. 8225 NET \$0.15

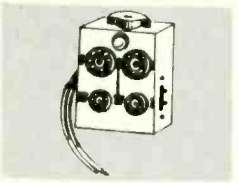

**TELCO POCKET TUBE CHECKER**

Series fil. and continuity tester.  
No. 9270 NET \$2.75

*Ask For These*



# SERVICE AIDS

*...at Your Jobber*



**TELCO UNIVERSAL LEAD-IN TUBE**

Fits 3/4" hole, 1/4" wall, brown.  
No. 8958 NET \$1.17

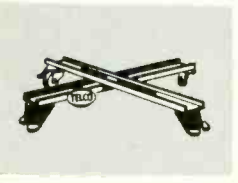

**TELCO TV SET ROLL-AROUND**

Fits all sets, easy to install.  
No. 8957 NET \$5.97

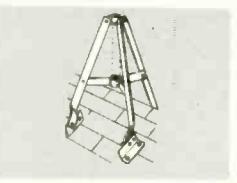

**TELCO TRIPOD TOWER BASE**

Supports 10' masts without guys.  
No. 9063 NET \$4.17

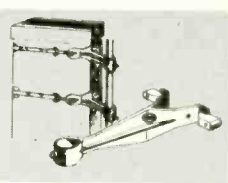

**TELCO CHIMNEY MOUNT BRACKETS**

Cast alum. pair for 1 1/2" masts.  
No. 8001 NET \$4.05

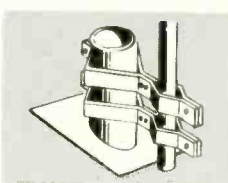

**TELCO VENT MOUNT**

Holds mast to 2" to 4" vents.  
No. 8802 NET \$1.35

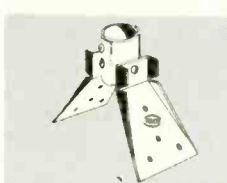

**TELCO UNIVERSAL RIDGE MOUNT**

Adjustable to peaks, flat roofs.  
No. 8906 NET \$1.17

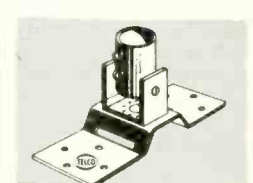

**TELCO FITZ-ALL MOUNT**

Use anywhere; masts to 2".  
No. 8804 NET \$1.77

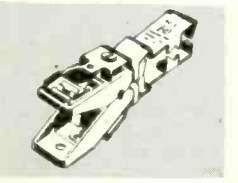

**TELCO 3-WAY TV LINE KLIP**

For straight, side, plug-in (RCA).  
No. 9015 NET \$0.13

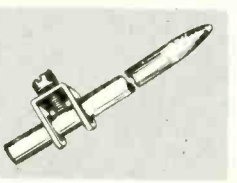

**TELCO GROUND ROD**

4 ft. long; 3/8" diameter.  
No. 8929 NET \$0.81

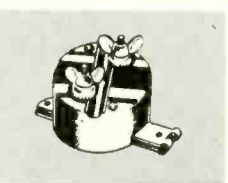

**TELCO UNIVERSAL LIGHT. ARRESTOR**

UL approved; UHF and VHF.  
No. 9242 NET \$0.45



**TELCO ACRYLIC SPRAY-KOAT**

Fast-drying outdoor-indoor use.  
No. 8665 NET \$1.19

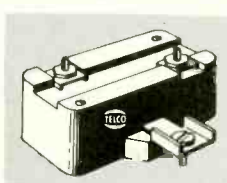

**TELCO SPECIAL LIGHT. ARRESTOR**

For 300-450-ohm open line; UL.  
No. 8640 NET \$0.60



**TELCO DELUXE LIGHT. ARRESTOR**

For all types TV lines, VHF & UHF.  
No. 8642 NET \$0.75



**TELCO RIGID-TYPE TV BASE**

Smart wrought black finish.  
No. 9082 NET \$3.57

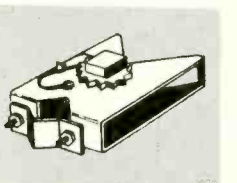

**TELCO RATCHET CHIMNEY MOUNT**

Galvanized straps; masts to 1 1/2".  
No. 9218 NET \$2.37

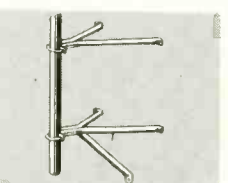



**TELCO TUBULAR WALL MOUNT**

15" mount; masts to 1 1/2".  
No. 9243 NET \$3.00

**FREE!**

Your copies of all current TELCO Catalogs. Send postcard today!







# TELEVISION HARDWARE MFG. CO.

Division of General Cement Mfg. Co. • 910 TAYLOR AVENUE • ROCKFORD, ILLINOIS

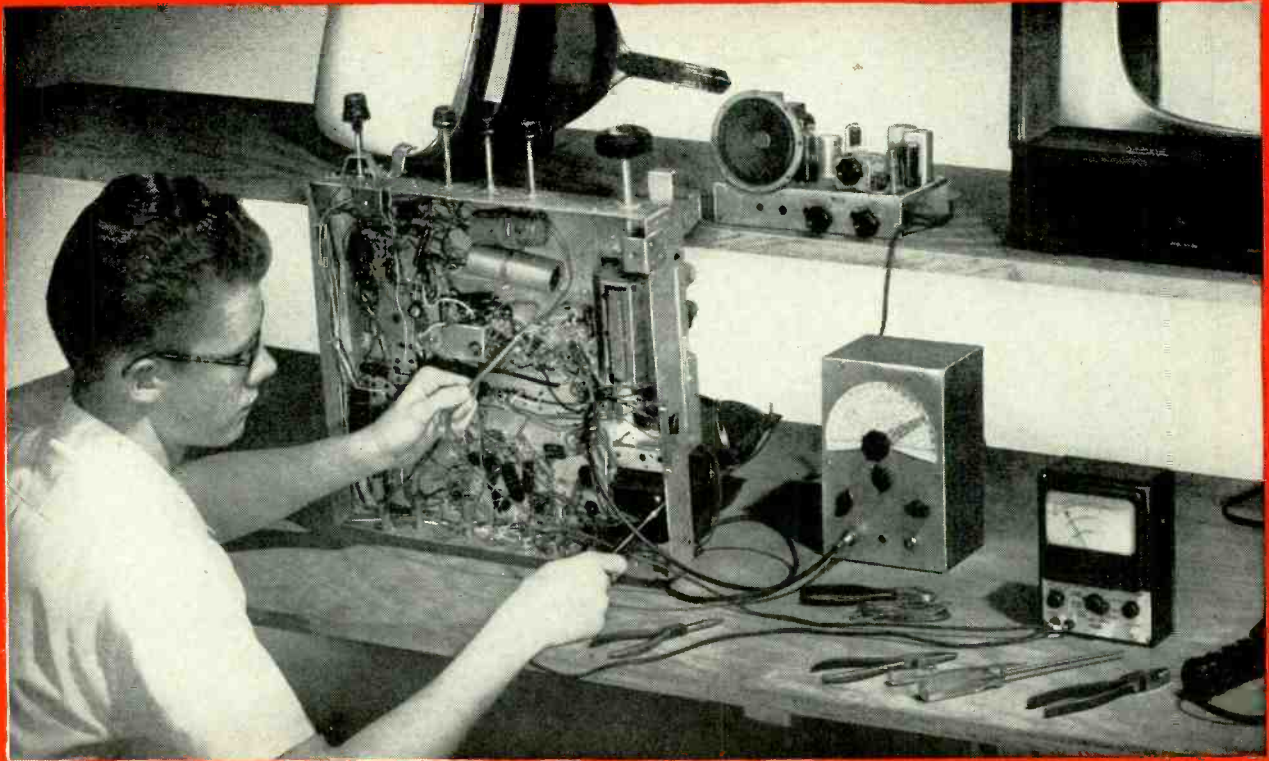



# NOW... RCA trains you at home to be an expert technician in...

**RADIO-TV ELECTRONICS**

**TV SERVICING**

**COLOR TV SERVICING**

**NOW THREE HOME STUDY COURSES...** prepared by instructors of RCA Institutes, engineers from RCA Laboratories, and training experts of the RCA Service Company. Clearly written... easy to understand... the same high caliber instruction as given in the resident classrooms of RCA INSTITUTES.

● **COURSE I—RADIO-TELEVISION ELECTRONICS.**—starts you from the ground up to a solid working knowledge of electronics. Without any previous experience, you get a thorough training in radio theory and servicing techniques for AM, FM, home and car radios... plus an introduction to the fundamental theory and practices of television.

● **COURSE II—TELEVISION SERVICING**—prepares you to advance from radio into the expanding field of television servicing as a well-trained service technician. If you have completed Course I or are now working in

the field of radio or TV, Course II will show you the many special techniques of troubleshooting, aligning, checking, and repairing modern black and white TV sets.

● **NEW TV KIT AVAILABLE WITH COURSE II**—there is no better way to learn than by *doing* and RCA Institutes has developed a large-screen TV KIT available to home study students to build while taking Course II. It has the most modern up-to-date circuitry, actually enabling you to apply at home all the latest servicing techniques.

● **COURSE III—COLOR TELEVISION SERVICING**—covers all phases of color servicing techniques. It is a practical, down-to-earth course in color theory as well as how-to-do-it servicing procedure. A natural move "up" from Course II or for those now employed in TV.

SINCE 1909, RCA INSTITUTES has trained thousands for successful careers in elec-

tronics. Many graduates have established their own paying business. Now this opportunity is available to you at home.

● **"PAY-AS-YOU-LEARN" PLAN**... you pay for one study group at a time, as you progress through the course. Tuition costs are amazingly low. For full details, mail coupon.

A SERVICE OF RADIO CORPORATION OF AMERICA—RCA INSTITUTES is licensed by the N. Y. State Education Department... recommended by radio and television service organizations.

**SEND FOR  
FREE  
CATALOG  
NOW**



**RCA INSTITUTES, INC.**  
A SERVICE OF RADIO CORPORATION of AMERICA  
350 WEST FOURTH STREET, NEW YORK 14, N.Y.

RCA Institutes, Inc., Home Study Dept. RE-125  
350 West Fourth Street, New York 14, N. Y.  
Without obligation, send me FREE CATALOG on Home Study Courses  
in Radio, TV and Electronics. No salesman will call.

Name \_\_\_\_\_ Please Print  
Address \_\_\_\_\_  
City \_\_\_\_\_ Zone \_\_\_\_\_ State \_\_\_\_\_

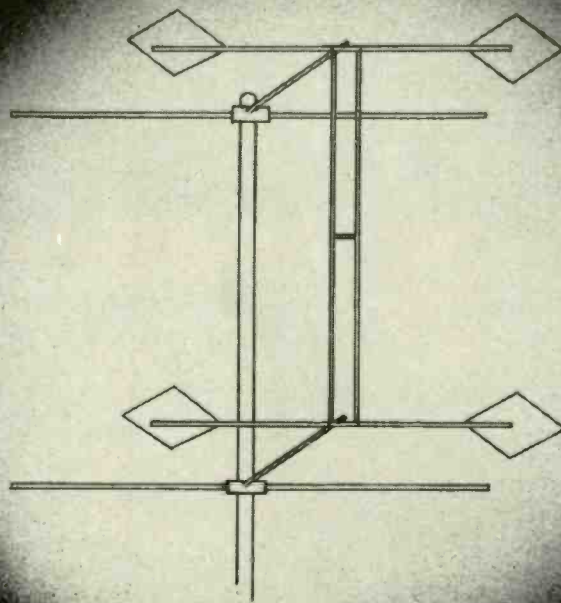

## ONLY ANTENNA WITH A FULL FIVE-YEAR GUARANTEE

End replacement problems. Guaranteed to be the most efficient all channel antenna available on a performance versus cost basis. Rugged all aluminum construction; heavy seamless tubing with stainless steel hardware.

PATENT PENDING

# WAYCO Inc.

WAYCO manufactures a full line of antennas and towers  
P.O. BOX 115 ● WAYNESBORO, TENNESSEE

# ALLIED'S own KNIGHT ELECTRONIC KITS...

## better by far...and you SAVE MORE



**NEWEST  
PRINTED CIRCUITS**

Get the most for your money in ALLIED'S KNIGHT Test Instrument Kits. Have the lab precision quality, the dependable accuracy, the professional styling you want—and SAVE MONEY. KNIGHT Kits are the last word in electronic design and the easiest to build. Instruction manuals are a marvel of simplicity and clarity for quick assembly without guesswork. You need only a soldering iron, screwdriver and pliers to assemble and own these professional quality instruments. Build one and you'll want to own more of these fine matched units.

**SAVE!** ALLIED—the reliable name in Electronics—gives you the greatest value for your test instrument dollar in KNIGHT Kits.

### KNIGHT PRINTED CIRCUIT 5" OSCILLOSCOPE KIT

**Model F-144** New wide-band, full-size 5" Oscilloscope; equals or betters the performance of commercially-wired 'scopes costing several times the price. Two printed circuit boards and exclusive laced wiring harness cuts assembly time to a minimum. Ideal for the professional Laboratory, for color TV servicing and high frequency applications. Has 6 times the usual sweep range—from 15 to 600,000 cps. Locks in frequencies as high as 9 mc. Vertical response from 5 cycles to 5 mc. Response:  $\pm 1$  div at 3.58 mc;  $\pm 3$  db at 5 mc. High vertical sensitivity of 25 rms mV/inch. Input capacitance 20 mmf. Outstanding features: cathode-follower vertical and horizontal inputs; 2nc anode provides 1400 volts for high-intensity trace; push-pull vertical and horizontal amplifiers; positive and negative locking; faithful square wave response; frequency-compensated input attenuator; Z-axis input for high-intensity modulation; one volt peak-to-peak voltage calibration; internal astigmatism control; blanking circuit to eliminate retrace lines; DC positioning control. Complete with all tubes and parts, ready for easy assembly. Handsome professional case finished in blue, with gray control panel. Shpg. wt., 40 lbs.

**Model F-144.** Knight Printed Circuit 5" Oscilloscope. Net only..... \$69.00  
**Model F-148.** Demodulator Probe. Net..... \$3.45  
**Model F-147.** Low Capacity Probe. 12 mmf. Net..... \$3.45

**\$69<sup>00</sup>**  
 \$6.90 down,  
 12 months  
 to pay  
 balance

### BUY WITH CONFIDENCE BUILD WITH CONFIDENCE

KNIGHT Kits are engineered to bring you the latest advances in electronic instrument design. The use of premium quality components assures absolute dependability.

KNIGHT Kits are designed for easiest assembly. It's just like having a good instructor at your side.

You and ALLIED are a team. ALLIED stakes its 30-year reputation in the Electronics field on your complete success and satisfaction.

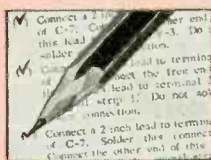

#### EXCLUSIVE ALLIED "STEP-AND-CHEK" ASSEMBLY METHOD

You just follow each step and check it off as you complete it. You always know where you are and what to do next with the wonderfully clear KNIGHT Manuals.

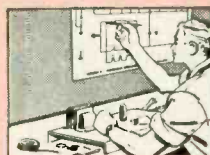

**EXCLUSIVE ALLIED  
"KING-SIZE" DIAGRAMS**  
 Diagrams are duplicated in large wall size to hang conveniently over your work. Helps you see and understand the finest details clearly and easily.

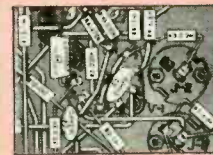

**EXCLUSIVE ALLIED  
"SPOTLIGHT" PICTORIALS**  
 Special two-tone treatment makes it easy for you to spot the circuit you're working on, separates it from work you've already completed. "You always know where you are."

### NEWEST PRINTED CIRCUIT

All Prices Net  
FOB Chicago

### EASY PAYMENT TERMS

If your total Kit order is over \$45, take advantage of our liberal Time Payment Plan—only 10% down, 12 full months to pay. Write for application form.



### KNIGHT PRINTED CIRCUIT VTVM KIT

**Model F-125** New extremely stable, highly accurate VTVM. Greatly simplified wiring—entire chassis is a printed circuit board. Features maximum convenience in arrangement of scales and controls. With peak-to-peak scale for FM and TV work. Ranges: AC peak-to-peak volts, 0-4-40-140-1400-4000; AC rms volts and DC volts, 0-1.5-5-15-50-150-500-1500; ohms, 0-1000, 10K, 100K; 1-10-100-1000 megs; db scale, -10 to +5. Uses low-leakage switches and 1% precision resistors. Balanced-bridge, push-pull circuit permits switching to any range without adjusting zero set. 4 1/2" meter, 200 microamp movement. Polarity reversing switch. Input resistance, 11 megs. Complete kit, ready to assemble. Shpg. wt., 6 lbs.

**Model F-125.** Knight Printed Circuit VTVM Kit. Net only..... \$24.95  
**Model F-126.** Hi-Voltage Probe; extends DC range to 50,000 Volts. Net..... \$4.50  
**Model F-127.** Hi-Frequency Probe; extends AC range to 250 mc. Net..... \$3.45

**\$24<sup>95</sup>**

order from **ALLIED RADIO**

100 N. Western Ave., Chicago 80, Ill.

**SEE FOLLOWING PAGES**

# ALLIED'S own **KNIGHT** ELECTRONIC KITS....

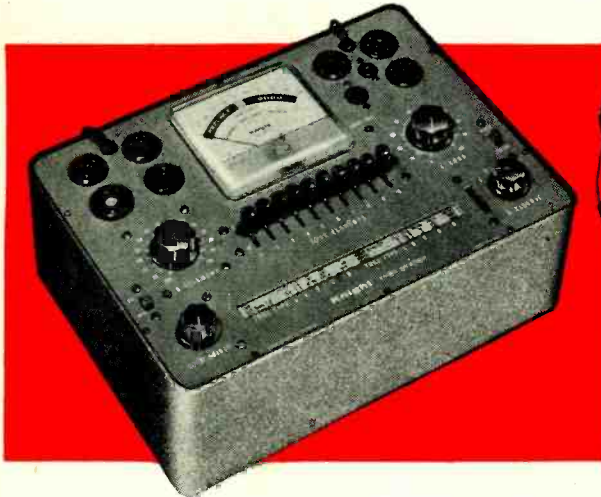

PORTABLE  
TUBE TESTER

Model F-143  
**\$29<sup>75</sup>**

## BUY WITH CONFIDENCE

- Advanced Electronic Design
- New Printed Circuits
- Easy-View, Hi-Legibility Panels
- Professional Streamlined Styling
- Matched Instruments
- Premium Quality Components

All Prices Net  
FOB Chicago



Model F-119  
**\$11<sup>65</sup>**

### KNIGHT EASY-TO-BUILD TUBE TESTER KIT—OUTSTANDING VALUE

Expertly designed, up-to-date, ideal for the laboratory or service shop. Remarkably low priced, yet it offers high accuracy, top versatility and convenience. Features provision for testing 600-ma tubes; roll-chart data for all popular series-string types. Tests 4, 5, 6 and 7-pin large, regular and miniature types, octals, loctals, 9-pin miniatures and pilot lamps. Tests for open, short, leakage, heater continuity and quality (by amount of cathode emission). 4½" square meter with clear "GOOD-?-REPLACE" scale. With line-voltage indicator and line-adjust control. Choice of 14 filament voltages from .63 to 117 volts. Blank socket for future type tubes. Universal-type selector switches for any combination of pin connections. Single-unit, 10-lever function switch simplifies assembly. Illuminated roll chart lists over 700 tube types. Complete kit, ready for easy assembly. Shpg. wt., 14 lbs.

Model F-143. Counter type Knight Tube Tester Kit. Net only..... **\$29.75**  
 Model F-142. As above, but with carrying case. Net only..... **\$34.75**  
 Model F-141. TV Picture Tube Adapter for above. Net only..... **\$3.75**

### KNIGHT CAPACITOR CHECKER KIT

Tests capacitors while they are still wired in the circuit! Saves time and trouble. Just press a button and the "magic eye" instantly shows opens and shorts. Checks by-pass, blocking, coupling and filter condensers from 20 mmf to 2000 mfd, even when the capacitor under test is wired with a resistance as low as 60 ohms. Capacitors between .1 mfd and 2000 mfd may be tested even when in parallel with resistance as low as 2 ohms. Housed in the professionally styled Knight Kit case, sturdy steel in blue wrinkle finish with gray control panel. Complete kit, ready for easy assembly. Shpg. wt., 5 lbs.

Model F-119. Knight Capacitor Checker Kit. Net only..... **\$11.65**



### KNIGHT 20,000 OHMS/VOLT VOM KIT

Model F-140 Outstanding quality and performance at extremely low cost. Features 32 ranges; full vision 4½" meter; ± 2% full scale deflection; 50 microampere sensitivity for 20,000 ohms/volt input resistance on DC; front panel "zero adjust". Single switch selects function and range. Range: AC, DC and output volts, 0-2.5, 10-50-250-1000-5000; Resistance, 0-2000-200,000 ohms and 0-20 meg.; DC ma, 0-1-10-100; DC amps, 0-1-10; Decibels, -30 to + 63 in 6 ranges. Uses precision 1% multipliers. Complete kit with bakelite case, batteries and test leads. Shpg. wt., 5 lbs.

Model F-140. Knight 20,000 ohms/volt VOM Kit. Net..... **\$26.50**



### KNIGHT 1,000 OHMS/VOLT VOM KIT

Model F-128 Exceptional accuracy and versatility at amazing low cost. Ideal for service shop, lab and Amateur use. Uses 4½" meter (400 microamp movement) with separate scales for AC voltage and current, DC voltage and current, decibels and resistance. 38 ranges include: AC, DC and Output volts, 0-1-5-10-50-100-500-5000 (1000 ohms/volt sensitivity); Resistance, 0-1000-100,000 ohms and 0-1 meg.; Current, AC or DC, 0-1-10-100 ma and 0-1 amps; Decibels, -20 to + 69 in 6 ranges. Uses 1% precision resistors. 3-position function switch and 12-position range switch. Complete kit with bakelite case, battery and test leads. Shpg. wt., 2½ lbs.

Model F-128. Knight 1,000 ohms/volt VOM Kit. Net..... **\$14.25**



Model F-124  
**\$18<sup>75</sup>**

### KNIGHT RESISTOR-CAPACITOR TESTER KIT

This new highly accurate tester meets the critical requirements of lab and service shop. Measures capacitance and resistance; checks for opens and shorts in paper, mica and ceramic capacitors; shows power factor of electrolytics. Large dial shows capacitance and resistance at a glance; balanced-bridge circuit with "magic eye" for correct dial setting. Measures power factor from 0-50%. Tests capacitors with rated voltages applied. 5 test voltages: 50, 150, 250, 350, 450. Capacity ranges: 10 mmf to .005 mfd, .001 to .5 mfd, .1 to 50 mfd and 20 to 1000 mfd. Resistance ranges: 100 to 50,000 ohms and 10,000 ohms to 5 megs. Accuracy, ± 10%. Automatic discharge feature prevents after-test shock. Complete kit with Knight professional portable case. Shpg. wt., 8 lbs.

Model F-124. Knight Resistor-Capacitor Tester Kit. Net only..... **\$18.75**

**EASY PAYMENT TERMS:** If your total kit order comes to over \$45, take advantage of our liberal Time Payment Plan—only 10% down, 12 full months to pay. Write for application form.

USE HANDY ORDER FORM  
ON NEXT PAGE

order from **ALLIED RADIO**

100 N. Western Ave., Chicago 80, Ill.

Everything in Electronics  
from One Reliable Source

# better by far...easiest to build...and you **SAVE MORE**

## KNIGHT LOW-COST RF SIGNAL GENERATOR KIT

An extremely popular kit, noted for its wide range and exceptional stability—saves you two-thirds the cost of a comparable wired instrument. Delivers output on fundamentals from 160 kc all the way out to 110 mc; useful harmonic output to 220 mc. Ideal for aligning RF and IF stages and for audio equipment troubleshooting. Also serves as TV marker generator when used with any sweep generator. Features the famous Colpitts circuit for high accuracy with negligible drift. RF output rated over 100,000 microvolts. Output can be modulated at 400 cycles. Has built-in sine-wave audio oscillator with output jack for 400 cycle output. Maximum audio output, 10 volts. Jack for external modulation; step and continuous-type output attenuators. Complete kit with professional portable case. Shpg. wt., 10 lbs.

Model F-145  
**\$19<sup>75</sup>**

Model F-145. Knight RF Signal Generator Kit. Net only.....\$19.75



All Prices Net FOB Chicago

### BUILD WITH CONFIDENCE

- Crystal-Clear Instruction Manuals
- Exclusive "Step-and-Chek" Building Method
- Exclusive "King-Size" Diagrams
- Exclusive "Spotlight" Pictorials

SAVE MONEY! Depend on ALLIED—the world's largest Electronic Supply House—get the most for your test instrument dollar.



Model F-137  
**\$31<sup>50</sup>**

### KNIGHT AUDIO GENERATOR KIT

Save money—have performance equal to instruments at many times the price! Provides an ideal audio frequency source for checking audio circuits of amplifiers and other hi-fi equipment; also checks speaker response. Frequency range: 20 cps to 1 mc in 5 ranges. Output voltage: 10 volts to high imp.,  $\pm 1$  db to 200 kc. Generator imp., 600 ohms. Less than 25% distortion from 100 cps through the audible range; less than 5% when driving 600 ohm load at maximum output. Continuously variable step-attenuated output. Circuit as developed by U. S. Bureau of Standards. Complete kit with professional portable case, ready to assemble. Shpg. wt., 17 lbs.

Model F-137. Knight Audio Generator Kit. Net. \$31.50

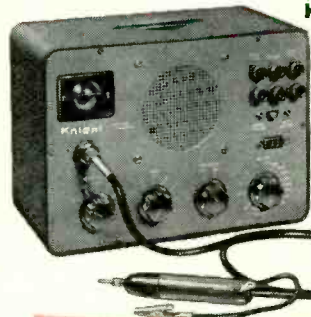

### KNIGHT VISUAL-AURAL SIGNAL TRACER KIT

A remarkable value in a kit which permits visual and aural signal tracing of RF, IF, video and audio circuits—costs no more than an audio signal tracer alone. Traces the signal from the antenna to the speaker. Reproduces signal at plate or grid connection of any stage. Identifies and isolates "dead" stages. Features: high usable gain of 50,000; "magic eye" with calibrated attenuators for signal presence indication and stage-by-stage gain measurements; built-in 4" PM speaker; RF probe for checking all stages; special audio probe tip included; provides noise test; built-in watt meter calibrated from 25 to 1000 watts; provision for external scope or VTVM. Complete kit with portable case. Shpg. wt., 13 lbs.

Model F-135  
**\$23<sup>75</sup>**

Model F-135. Knight Visual-Aural Signal Tracer Kit. Net only.....\$23.75

## KNIGHT AMPLIFIER KITS FOR HI-FI BUILDERS

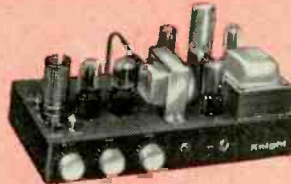

### 10-WATT HI-FI AMPLIFIER KIT

Model S-234 Famous for wide response and smooth reproduction at low cost. Only 0.5 volt drives amplifier to full output. Frequency response:  $\pm 1$  db, 30-20,000 cps at 10 watts. Harmonic distortion less than 0.5% at 10 watts. Intermod. distortion less than 1.5% at full output. Controls: on-off-volume, bass, treble. Input for crystal phono or tuner. Chassis punched to accommodate preamp kit. Matches 8 ohm speakers. Shpg. wt., 14 lbs.

Model S-234. Amplifier Kit. Net. \$20.95  
Model S-235. Preamp Kit for above. Net. \$2.75

### 20-WATT HI-FI AMPLIFIER KIT

Model S-750 True hi-fi for less! Frequency response,  $\pm 1$  db, 20 to 20,000 cps at 20 watts. Distortion, 1% at 20 watts. Hum and noise level: tuner input, 90 db below 20 watts; phono, 72 db below 20 watts. Sensitivity: tuner input, 0.6 volt for 20 watts output; magnetic phono, .007 volts. 4 inputs: magnetic phono, microphone, crystal phono or recorder, and tuner. Controls: Bass, Treble, Volume, Selector. With compensation positions for 78 and LP records, controlled from front panel. Shpg. wt., 23 lbs.

Model S-750. 20-Watt Hi-Fi Amplifier. Net.....\$34.75

### HOBBYIST SPECIAL!



Model S-243  
**\$13<sup>95</sup>**

### KNIGHT "SPACE SPANNER" RECEIVER KIT

All-new 2-band receiver in easy-to-build kit form at a very low price. Pulls in thrilling short-wave (6 to 17 mc), including foreign broadcast, amateurs, aircraft, police and marine radio, as well as standard broadcast. Band-switch selects broadcast or short-wave—no plug-in coils. Features: 4" PM speaker and beam power output for plenty of volume; headphone connections; band-spread for easy short-wave tuning; highly sensitive regenerative circuit. Tubes are 12AT7 regenerative detector and audio amplifier, 50C5 output; 35W4 rectifier. Includes all parts and tubes; less only wire and solder. For AC or DC operation. Shpg. wt., 4 1/2 lbs.

83 S 243. Knight "Space Spanner" Kit. Net.....\$13.95

## ALLIED RADIO

Allied Radio Corp., Dept. 2-M-5, 100 N. Western Ave., Chicago 80, Ill.

Ship me the following KNIGHT Electronic Kits:

Quantity	Description	Model No.	Price

\$.....enclosed. For parcel post include postage (express is shipped collect).

Name.....

Address.....

City..... Zone..... State.....

**ORDER TODAY**

# CABINART '56 - HI FI CABINET KITS

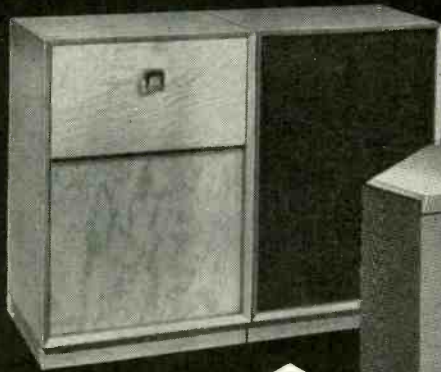

**MODEL 27K  
MODEL 28K**  
matched equipment  
and speaker  
cabinets

Hi Fi  
wall storage  
units

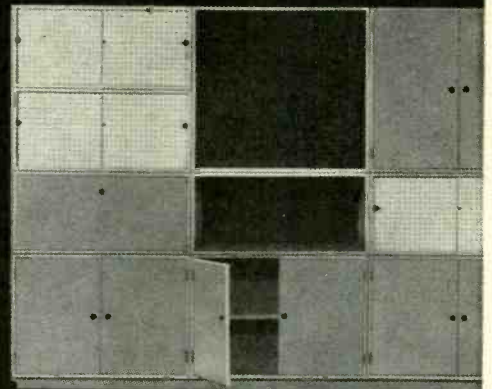

**Model K-3**  
newest Rebel\*  
corner folded horn kit



**... all you need is a screwdriver!**

Machined wood pieces key exactly to each other! Pre-shaped, pre-drilled, pre-engineered and not a scrap of sawdust left over!

## THE REBEL K-3

Identical acoustically with the KR-3, first and largest of the Klipsch-designed Rebel series of corner folded horns. Using the mirror images of room walls at a corner, the K-3 extends bass down nearly to 30 cycles! Two companion Rebel kits are more economical but only in price and size.



**K-3 . . . \$54.00**

Prices slightly higher west and south

## THE "ST" SERIES

Wall storage units . . . ten basic Cabinart designs in kitform or assembled, ready to finish. Each is tailored to the needs of hi-fi installations. The Series includes a *nine cubic foot bass reflex cabinet*.

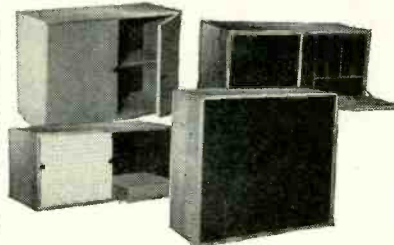

Prices from  
**\$21.00 to \$36.00**

## FURNITURE KITS

The new 27K and 28K typify Cabinart kit utility and economy. Both point up the unique design functions necessary to the correct hi-fi installation.



**Equipment Cabinet**  
**\$51.00**



**Bass Reflex**  
**\$39.00**

WRITE FOR THE NAME OF YOUR NEAREST DEALER AND MAIL ORDER HOUSE.

kits by **cabinart** . . . the pioneers in radio furniture  
for high fidelity.

99 NORTH 11th STREET, BROOKLYN 11, NEW YORK

\*Trademark

WRITE

1. Equipment Storage
2. Equipment/Speaker Enclosure Kits
3. The Rebel Speakers
4. Wall Storage Cabinets
5. Accessories By Cabinart



Prepare for a Good Paying Job — Or Your Own Business

Learn PRACTICAL RADIO-TV  
with 25 BIG KITS

of equipment I send you while you train with me . . . for valuable shop bench experience . . .

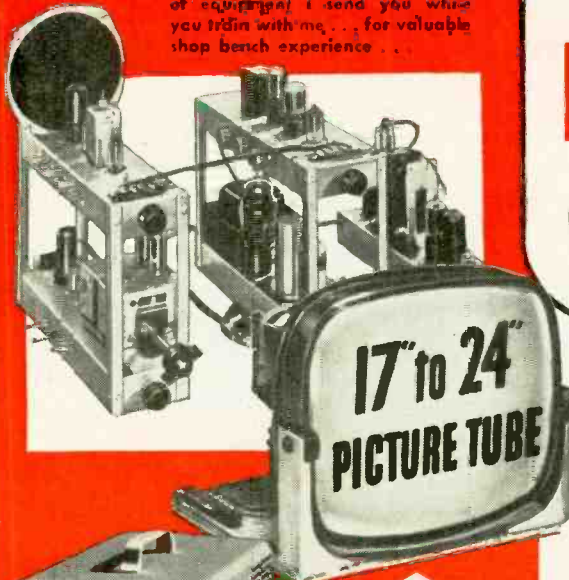

This is the new Sprayberry Training Television receiver, built and tested in sections for greatest instruction value.

I now offer this fine modern oscilloscope to help you learn practical Television servicing.

You will build this powerful short wave and broadcast superhet radio receiver for valuable shop instruction practice.

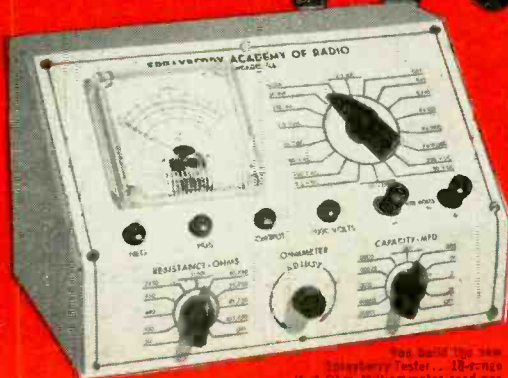
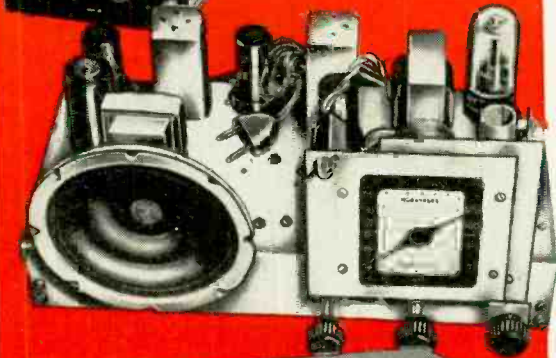

Now build the new Sprayberry Tester . . . 18-range Volt Ohm Milliammeter reads meg ohms output meter and condenser and resistor substitution scale too.

In addition to modern lesson training, I also give you plenty of home practice on actual Radio-Television equipment . . . you will build and use the units shown here plus many more. All this equipment is yours to keep . . . keep everything you need to set up your shop.

"I Will Train You at Home in  
**RADIO-TELEVISION**  
On Liberal No Obligation Plan!"

New Equipment! New Lessons! Enlarged Course! The true facts are yours in my big new catalog . . . YOURS FREE . . .

JUST MAIL COUPON!

I can train and prepare you in as little as 10 months to step into the big opportunity Radio-Television service field. Train *without* signing a binding contract . . . without obligating yourself to pay any regular monthly amounts. You train entirely at home in spare hours . . . you train as fast or as slowly as you wish. You'll have your choice of THREE SPRAYBERRY TRAINING PLANS . . . planned for both beginners as well as the more experienced man. Get the true facts about the finest most modern Radio-Training available today . . . just mail the coupon for my big new 56 page fact-filled catalog plus sample lesson—both FREE.



Frank L. Sprayberry  
President, Sprayberry  
Academy of Radio

Train the Practical Way—with Actual Radio-Television Equipment

My students do better because I train both the mind and the hands. Sprayberry Training is offered in 25 individual training units, each includes a practice giving kit of parts and equipment . . . all yours to keep. You will gain priceless practical experience building the specially engineered Sprayberry Television Training Receiver, Two-Band Radio Set, Signal Generator, Audio Tester and the new Sprayberry 18 range Multi-Tester, plus other test units. You will have a complete set of Radio-TV test equipment to start your own shop. My lessons are regularly revised and every important new development is covered. My students are completely trained Radio-Television Service Technicians.

NEWEST DEVELOPMENTS

Your training covers U H F, Color Television, F M, Oscilloscope Servicing, High Fidelity Sound and Transistors.

See for Yourself . . . Make Your Own Decision . . . Mail Coupon Today!

The coupon below brings you my big new catalog plus an actual sample Sprayberry Lesson. I invite you to read the facts . . . to see that I actually illustrate every item I include in my training. With the facts in your hands, you will be able to decide. *No salesman will call on you.* The coupon places you under no obligation. Mail it now, today, and get ready for your place in Radio-Television.

SPRAYBERRY ACADEMY OF RADIO

111 North Canal Street, Dept. 20-F Chicago 6, Illinois

Mail This Coupon For Free Facts and Sample Lesson



SPRAYBERRY ACADEMY OF RADIO  
Dept. 20-F, 111 N. Canal St., Chicago 6, Ill.

Please rush all information on your ALL-NEW Radio-Television Training Plan. I understand this does not obligate me and that no salesman will call upon me. Include New Catalog and Sample Lesson FREE.

Name \_\_\_\_\_ Age \_\_\_\_\_

Address \_\_\_\_\_

City \_\_\_\_\_ Zone \_\_\_\_\_ State \_\_\_\_\_

# Do you OVERPAY for QUALITY instruments?

EICO's mass purchasing and world-wide distribution, together with advanced electronic design, produce values never before possible . . . to give you Laboratory Precision at Lowest Cost!

GET the MOST for YOUR MONEY! Don't buy ANY test instrument till you put the EICO INSTRUMENT (kit or wired) equivalent before you—and . . .

Compare advanced electronic design: see the latest in circuitry and features.

Compare finest components: see the famous brands you know and trust, such as GE, Centralab, Mallory, etc.

Notice ease of construction and operation: Exclusive "Beginner-Tested" Manuals make assembly and operation step-by-step, quick, crystal-clear. "You build them in one evening—they last a lifetime!"

Check 5-Way Guarantee: Only EICO gives you this exclusive complete protection! EICO guarantees components, instructions and satisfactory operation — AND guarantees service and calibration for the LIFETIME of the instrument, at less than cost of handling.

Compare feature for feature, dollar for dollar.

There's an EICO distributor right nearby in your own neighborhood — over 1200 coast-to-coast. EICO planned it that way so that you can easily examine EICO BEFORE YOU PUT DOWN ONE CENT OF YOUR MONEY!

COMPARE any of EICO's 46 models SIDE BY SIDE with ANY competitor. Then YOU judge who's giving you the MOST for your money.

Over 500,000 EICO instruments in use . . . You'll agree EICO gives you LABORATORY PRECISION AT LOWEST COST.



## FREE 1956 EICO CATALOG!

Tells you how to SAVE 50% on your test equipment costs!

### NEW RF SIGNAL GENERATOR #324



**KIT \$26.95**  
**Wired \$39.95**  
Ill. dial

150 kc-435 mc; 6 fund. bands.



**NEW WIDE BAND DC-5MC 5" OSCILLOSCOPE #460**  
**KIT \$79.95**  
**Wired \$129.50**  
Designed for color TV servicing & laboratory use. DC vert. amplifier, flat DC-4.5 mc.



**5" PUSH-PULL OSCILLOSCOPE #425**  
**KIT \$44.95**  
**Wired \$79.95**  
**7" PUSH-PULL OSCILLOSCOPE #470**  
**KIT \$79.95**  
**Wired \$129.50**



**VACUUM TUBE VOLTMETER #221**  
**KIT \$25.95**  
**Wired \$39.95**  
**DELUXE VTVM #214 (7 1/2" METER)**  
**KIT \$34.95**  
**Wired \$54.95**



**#232 Peak-to-Peak VTVM with AC/DC UNI-PROBE (pat. pend.)**  
**KIT \$29.95**  
**Wired \$49.95**  
**Deluxe #249 with 7 1/2" Meter**  
**KIT \$39.95**  
**Wired \$59.95**

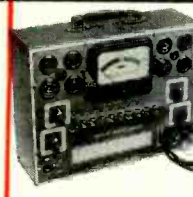

**TUBE TESTER #625**  
**KIT \$34.95**  
**Wired \$49.95**  
• tests 600 mil series string type tubes  
illuminated roll-chart  
**Pix Tube Test Adapter .....\$4.50**



**#944 FLYBACK TRANSFORMER & YOKE TESTER**  
**KIT \$23.95**  
**Wired \$34.95**  
• fast check all flybacks & yokes in or out of set.  
• spots even 1 shorted turn!



**TV/FM SWEEP GENERATOR #360**  
**5MC-4.5MC CRYSTAL .....\$3.95 ea.**  
Range 500 kc-228 mc on fund. Cont. sweep width control, 0-30 mc.  
**KIT \$34.95**  
**Wired \$49.95**



1% accuracy on all 7 ranges. Range 75 kc-150 mc. Volt reg.  
**KIT \$39.95**  
**Wired \$59.95**



Sep. volt-meter & ammeter  
**KIT \$29.95**  
**Wired \$38.95**

**6V & 12V BATTERY ELIMINATOR & CHARGER #1050**



Sep. hi-gain RF & lo-gain audio inputs. Special noise locator. Calibrated wattmeter.  
**KIT \$24.95**  
**Wired \$39.95**

**DELUXE MULTI-SIGNAL TRACER #147**



Reads 0.5 ohms -500 megs, 10 mmfd-5000 mfd power factor.  
**KIT \$19.95**  
**Wired \$29.95**

**R-C BRIDGE & R-C-L COMPARATOR #950B**

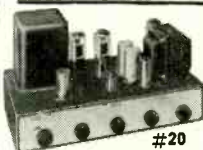

**NEW! High Fidelity Amplifier #20**  
**KIT \$49.95**  
**Wired \$79.95**

20-20,000 cps ±0.5db IM distortion 1.3%. Harmonic distortion 0.3%. All at 20 watts. Ultra Linear Williamson, 5 pos. equal, tone & loudness controls.

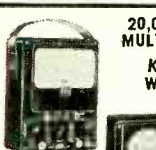

**20,000 Ohms/Volt MULTIMETER #565**  
**KIT \$24.95**  
**Wired \$29.95**



**1000 Ohms/Volt MULTIMETER #536**  
**KIT \$12.90**  
**Wired \$14.90**

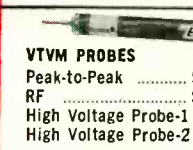

**VTVM PROBES**  
Peak-to-Peak ..... \$4.95 \$6.95  
RF ..... \$3.75 \$4.95  
High Voltage Probe-1 ..... \$6.95  
High Voltage Probe-2 ..... \$4.95

**SCOPE PROBES**  
Demodulator ..... \$3.75 \$5.75  
Direct ..... \$2.75 \$3.95  
Low Capacity ..... \$3.75 \$5.75

For FREE 1956 catalog, mail coupon NOW!



84 Withers St. • Brooklyn 11, N. Y.

Prices 5% higher on West coast and subject to change without notice. ©55

EICO, 84 Withers Street  
Brooklyn 11, New York C-12

Send FREE 1956 Catalog and name of neighborhood EICO jobber.

Name.....

Home Address.....

City.....Zone.....State.....

Occupation.....

1945 to 1955: a decade of Know-How & Value Leadership in Kits & Instruments—over 1/2 million sold to date!



## AVIATION ELECTRONICS

... *Anticollision Radar imperative now* ...

IN few endeavors has electronics solved so many knotty questions as in flying—yet we are only at the beginning for the most important and difficult problems are still to be overcome.

One has only to step into the cockpit of a modern four-motored plane and see the bewildering array of the more than a hundred meters, indicating dials and controls to realize that nowadays no large aircraft could possibly navigate and land without electronics. The radiophone, radar, DF, altimeter, ILS (Instrument Landing System) and a multitude of other purely electronic gadgets on board—all are in constant use by the operating crew.

On the ground, we have GCA (Ground-Controlled Approach radar) and omnirange, now standard requirements of the Civil Aeronautics Administration for civilian airports. Soon all our principal airports will be equipped with GCA. The new radar installations will eliminate most delays in landings due to fog and low visibility during instrument flight approaches.

A recent instrumentality, "video mapping," reproduces a map electronically, showing the pilot runways, terrain obstacles and hazards as well as the proper flight plans for approaching and departing planes. This system will also enable pilots to land and take off at the rate of one every minute, despite poor weather conditions, at even the most congested airports.

In addition to these we have TACAN (TACTical Air Navigation) that instantly and automatically informs the pilot of his true distance and bearing from a fixed ground station. VOLSCAN, another recent aviation aid, is an electronic computer that controls dense air traffic automatically. With it the U. S. Air Force can now control 120 jets under conditions where no human can direct more than 40 planes per hour.

Some of the larger new planes are also being equipped with weather radar. Storms, thunderstorms and adverse air turbulence show clearly on the radarscope—these can often be either flown over or sidestepped by the pilot to make possible smoother flights. This also safeguards the plane from excessive wear and tear—or worse. The equipment will also indicate large obstacles, such as mountains, straight ahead of the plane.

But as time goes on, planes become much faster and far more numerous. Today's speeds of 250 to 370 miles will soon be memories. Passenger jets are even now flying at 600 miles. Soon *all* planes will be flying near subsonic speeds. In the U. S. today we have around 1,500 multi-engined commercial planes. There are an even larger number of military and foreign planes. Add to this some 20,000 business and various private planes.

If we consider that there are now over 30,000 daily scheduled airline arrivals and departures in the U. S., we realize

that the skies are really becoming crowded. What will the situation be 10, 20 years hence?

In the meanwhile, planes still collide with various obstacles, such as buildings, mountains—and other planes. Unless steps are taken to remedy this, such fatalities—rarely are there survivors—will become worse. We have, for many years, advocated special anticollision radar in this publication.\* They should be made mandatory by law. Until recently commercial airlines were not interested in such safeguards because of their great weight, bulk and high cost.

With today's miniaturized components and transistors becoming mass-produced, such objections are rapidly being overcome.

A good deal of research and know-how does remain to be done. A plane must be safeguarded from six directions: front, rear, both sides, above and below. Obviously, a single *unidirectional* radar won't do. A revolving search radar cannot be placed inside the metal-covered fuselage. It must remain *outside* and protected by a plastic or other non-metallic enclosure. But such igloo-shaped structures on top (and beneath) the fuselage pose certain aerodynamic problems which also must be solved—as they will be in the near future.

How necessary and important anticollision radar has become can best be demonstrated if we consider trans-Atlantic air traffic. There are now an average of 58 passenger flights daily over the Atlantic at the peak season. There are more than 30 planes over the Atlantic at one time. These figures disregard military and freight planes.

On a recent westward trans-Atlantic flight, we counted over 15 commercial four-motored passenger planes on the airport runways of both Shannon (Ireland) and Gander (Newfoundland). Nearly all were ready to depart but had to waste valuable time due to a *new ruling which requires that 15 minutes must elapse between takeoffs of all planes flying at the same altitude*. Without such spacing collisions would be inevitable.

One might think that such a rule is foolish, considering the vastness of the ocean. It is not. Planes fly a very narrow route in each direction—the shortest line between two airports. The weather too dictates the planes' altitude; they all fly approximately 10,000, 15,000 or 20,000 feet above the ocean. These heights may be varied by 1,000 or more feet in heavy traffic so as to space the planes safely in various "layers." So the air routes are, perforce, crowded.

Airplane captains look with concern toward the 1956 season, when, so we were told, there will be twice as many planes over the Atlantic as in 1955. . . . Anticollision radar is imperative now!

—H. G.

\* "Radar Possibilities," May, 1945; "Needed Electronic Inventions," May, 1951.

  
**The Editors wish you a Happy Christmas and a Wonderful New Year**  



Panel view of the engine analyzer.

# Cathode-Ray Engine Analyzer

By C. B. DeHUFF\*

**D**EFFECTS in the ignition system of an engine are responsible for poor operation in a great many cases. To provide technical services to customers using petroleum products, the Socony Mobil Oil Co. developed

an instrument to analyze quickly the ignition performance of automotive engines. The idea of a raster sweep oscilloscope was conceived to display the ignition characteristics events in each cylinder to enable direct comparison of all cylinders. The ignition character-

istics of each cylinder are spread for detail to the full width of the cathode-ray tube.

The instrument may be connected to any engine merely by attaching two capacitive clips to the insulated spark-plug wires. This supplies all the syn-

\* Research and Development Department, Socony Mobil Oil Company, Inc., Paulsboro, N. J.

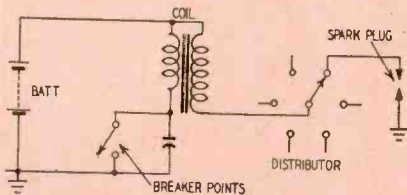

Fig. 1—Basic auto ignition system.

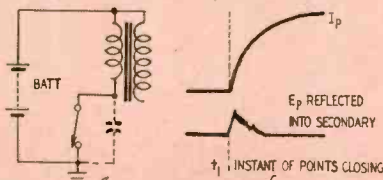

Fig. 2—Breaker points are closed

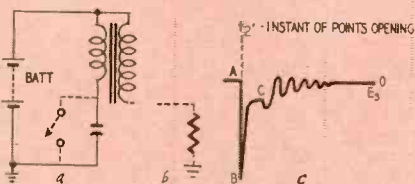

Fig. 3—Ignition circuit—points open.

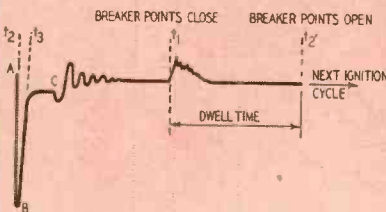

Fig. 4—The complete ignition cycle.

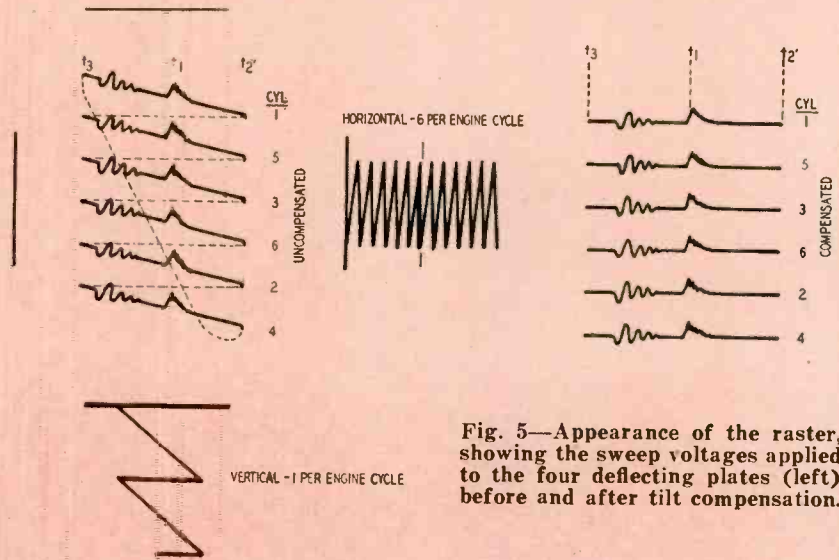

Fig. 5—Appearance of the raster, showing the sweep voltages applied to the four deflecting plates (left) before and after tilt compensation.

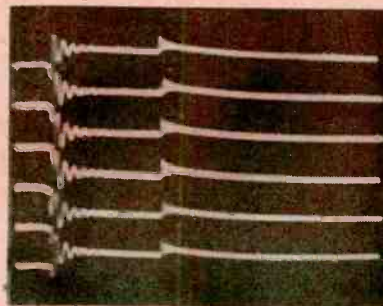

Fig. 6—Normal six-cylinder pattern.

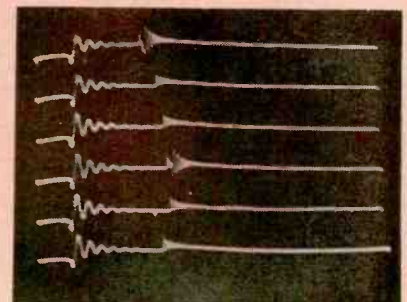
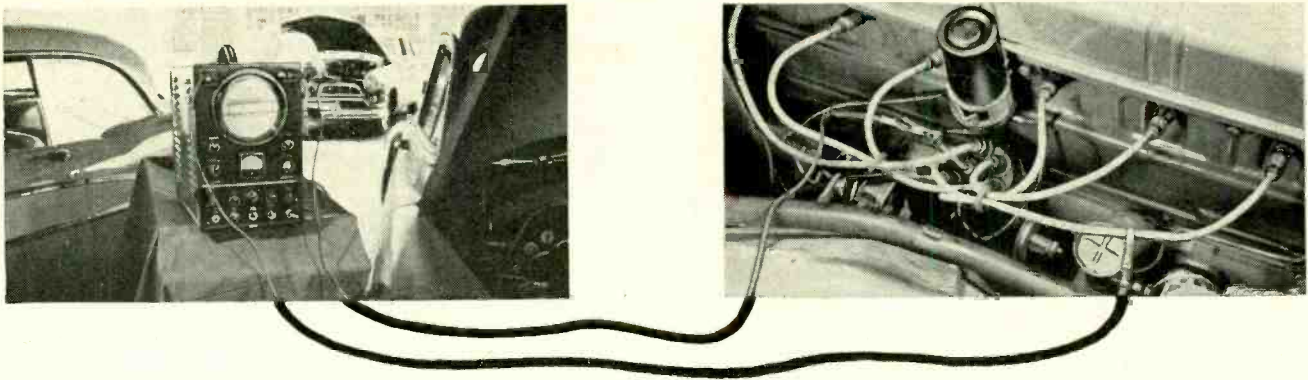

Fig. 7—Defective distributor points.



Closeup shows electrical connection to engine—capacitive clips are used.

chronization and pattern information. Panel controls are relatively simple and power can be supplied from a 115-volt 60-cycle source.

The Allen B. Du Mont Laboratories, who assisted in the development, produced a limited number of these instruments for use by the Socony Mobil laboratories and field engineers. With this instrument, ignition-system defects such as fouled spark plugs, plug gaps, distributor points and coil operation are analyzed. The device should find wide use from large fleet type automotive maintenance shops and with the progressive automotive dealer to the tune-up pits of racing enthusiasts. The idea of the raster sweep makes it unique, and its ease of engine connection will increase acceptance. Sooner or later the electronic service technician is going to meet it face to face.

A typical automotive ignition system (Fig. 1) consists of a battery, coil primary, distributor breaker points and capacitor in the primary circuit, and coil secondary, distributor rotor and spark plugs in the secondary circuit. The value of capacitance on a 6-volt system is usually between 0.15 and 0.40  $\mu$ f to reduce arcing across the points and to insure a sudden collapse of the magnetic field about the coil. A typical 6-volt ignition coil may have a primary resistance of from 0.9 to 2.0 ohms and a primary inductance of from 5 to 10 mh. The turns ratio, secondary to primary, may fall in the range of 40:1 to 100:1 with between 9,000 and 25,000 turns on the secondary.

At the instant of closing the primary breaker points, the capacitor is short-circuited (Fig. 2-a). The coil primary

circuit is completed and current flows from the battery in a manner similar to curve  $I_p$  in Fig. 2-b. At the instant of point contact a very slight oscillation occurs in the coil secondary circuit. This may be seen with a high-gain oscilloscope and is shown in Fig. 2-b as the curve of  $E_p$ , reflected into the secondary. Time  $t_1$  is the instant the distributor breaker points close.

When the distributor breaker points open, the ignition circuit may be represented by Fig. 3-a which shows the secondary still open-circuited. At this instant the capacitor is thrown into the primary circuit in series with the primary inductance of the coil. The magnetic field about the coil suddenly collapses, aided by the capacitor, and a very high negative voltage is generated in the secondary winding as indicated by the expression:

$$e = N \frac{d\Phi}{dt} \times 10^{-8}$$

where  $e$  = volts,  $N$  = number of turns in the secondary winding, and  $\frac{d\Phi}{dt}$  = rate of change of magnetic lines of flux.

When the voltage reaches a high enough value to arc over, the secondary circuit becomes loaded (Fig. 3-c) by the spark. In Fig. 3-c the portion of the secondary voltage waveform between A and B represents the sudden surge to the point of arcing, after which the voltage returns to a much lower value—B to C. At a time corresponding to C there is no longer sufficient energy in the coil to maintain the arc and the arc goes out, removing the secondary load. With the secondary unloaded the remaining energy is dis-

sipated in the form of a damped oscillation, starting at point C, until it reaches zero (Fig. 3-c). When the breaker points close again, the ignition cycle is repeated.

Fig. 4 shows a typical oscilloscope pattern of an ignition cycle if the horizontal sweep begins with the large negative pulse coincident with the opening of the points,  $t_2$ . Time  $t_2'$  would correspond to the time of points open, or the spark, for the next cylinder in the firing order. There are many instances in which it would be satisfactory to examine just one of these ignition events at a time. More frequently, however, it is a distinct advantage to be able to compare what is occurring during one ignition cycle with similar events in other cylinders. For oscilloscope ignition analysis of a six-cylinder engine six patterns must be strung out in parade fashion.

On a 5-inch cathode-ray tube, detail is definitely obscured by this arrangement and it becomes desirable to lengthen the time base appreciably so that details may be observed for comparison and measurement. One way to lengthen the sweep time base and still keep the six patterns on the tube face would be to use a circular sweep. This would result in roughly a threefold increase in time-base length, but events occurring during the portion of the sweep at the bottom of the tube face would appear inverted and reversed. This is definitely not desirable for comparisons.

#### Obtaining the raster

The method used in the new cathode-ray engine analyzer is to apply a saw-

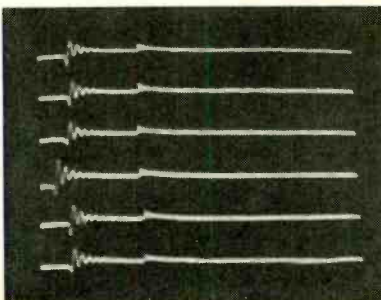

Fig. 8—Pattern shows large spark gap.

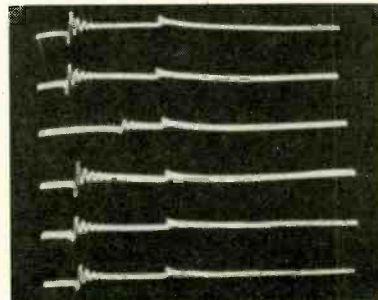

Fig. 9—Pattern shows a shorted plug.

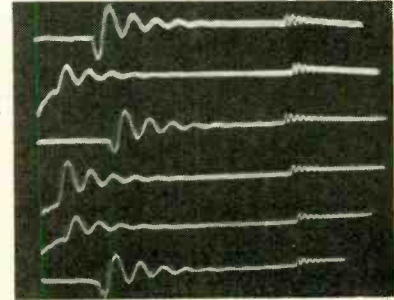

Fig. 10—Deposit-fouled spark plugs.

## ELECTRONICS

tooth wave to the vertical deflection plates and synchronize this with the engine once every complete engine cycle. The result is a vertical sweep coincident with a horizontal sweep. If the horizontal sweep is synchronized to the same point in every ignition cycle, the result is a series of horizontal traces displaced from each other vertically. This arrangement provides for a maximum of detail, and comparison of ignition events—cylinder to cylinder—is possible.

As described, however, each horizontal trace will have a downward slope due to the vertical sweep. This can be compensated for by coupling a portion of the horizontal sweep voltage into the vertical channel to bring the lines back to the horizontal.

The high negative pulses (at  $t_1$ ) from the ignition coil trigger the horizontal sweep and initiate trace blanking and flyback. This produces a horizontal trace on the left side of the tube face at time  $t_1$  instead of time  $t_2$ . The action of the rotor in the distributor is to distribute the energy from the coil to the proper spark plug in the engine firing order. If the high negative pulse at No. 1 spark plug is used to trigger the vertical sweep, then the top trace in the analyzer raster represents events occurring from the time of spark in No. 1 cylinder until the time of spark in the next cylinder in the firing order of the engine—and so on until No. 1 again fires and begins the raster over again.

Fig. 5 shows the final analyzer raster for a six-cylinder engine before and after tilt compensation.

Since, for a four-cycle engine, there are two crankshaft revolutions for every engine cycle and one complete analyzer raster represents one complete engine cycle, at any engine speed the crankshaft turns through  $720^\circ$  during the time from  $t_1$  for cylinder No. 1 to  $t_2$  for the next firing of cylinder No. 1. During this interval the distributor has gone through only one revolution,

or  $360^\circ$ . Neglecting the minute fraction of time required for flyback for each line, each trace of a six-cylinder raster represents  $60^\circ$  of camshaft rotation. The face of the tube can be scaled to measure directly the duration of points closing, or dwell time, in terms of camshaft degrees. This is a very important and accurate check on the setting of the distributor breaker point gap.

### Using the instrument

It is a very simple matter to set up the analyzer for operation (see block diagram). If it is desired to take the instrument in a vehicle—this is frequently necessary to permit the engine to develop the trouble to be analyzed—the analyzer can be connected to the battery through a suitable inverter. Plain, unshielded, single-conductor test lead wire terminating in a capacitive clip is used to clip onto the high-voltage lead from the coil to the distributor rotor for horizontal synchronization and signal information, and onto the high-voltage lead to No. 1 spark plug for vertical synchronization.

A portion of the horizontal synchronization signal is taken off at the input and fed through one half of a differential amplifier. This signal contains all the secondary voltage information pertinent to all cylinders and is applied to the vertical deflection plates. The input to the differential amplifier may be switched to cut out the ignition information from the secondary voltage, and to cut in an external pickup which may be used to study detonation, spark advance, pre-ignition and manifold pressures.

A front-panel control adjusts the amount of vertical sweep fed to the vertical deflection amplifiers so that the line spacing may be controlled. Continuous adjustment is possible from zero spacing—all lines superimposed on one another—to maximum spacing which allows for practically individual observation. Adjusting the gain in the horizontal deflection amplifier permits

a magnified view of selected portions of the ignition cycle for very close detail. A 0-200- $\mu$ a meter is connected in series with the constant-current tube of the horizontal sweep generator to indicate engine r.p.m. The meter reads the average tube current which is proportional to the frequency and therefore the speed of the engine. A selector switch connects capacitors in the sweep generating circuit to maintain meter calibration for engines of different numbers of cylinders. Other front-panel controls include: intensity and focus, horizontal and vertical lock, horizontal and vertical positioning.

Some typical displays are reproduced in Fig. 6, a standard six-cylinder ignition pattern, and Fig. 7, a case of bad distributor-point contact. An examination of the points in this case would reveal pitting such that, as the points start to close, a momentary contact is first made when the buildup on one point brushes the edge of the crater on the other. As the points continue to close this momentary contact is broken until the buildup on the point rests firmly in the crater of the other, at which time final contact is made.

The effect of a wide gap in one spark plug, as compared with the gaps in the other plugs, is shown in Fig. 8. In this photograph line 4, corresponding to cylinder No. 6 in the firing order 1-5-3-6-2-4, shows a much shorter spark line. With a wide gap more energy is required to maintain the arc and so the condition is reached much earlier where there is no longer sufficient energy to maintain the arc and the arc goes out. The slightly larger oscillation illustrates the greater energy in the coil-capacitor circuit left over after arc-out.

Fig. 9 shows the pattern observed with spark plug No. 3 (line 3) completely fouled to a dead short by deposits. In this case there is still a spark gap left in series with the secondary circuit. It is the gap between the distributor rotor and the posts in the distributor cap. With only one gap left in the circuit much less energy is required to maintain the arc, which continues for a much longer time. When the arc does go out, there is much less energy left in the coil-capacitor circuit and a much lower amplitude oscillation follows arc-out.

Fig. 10 shows a stage of spark plug fouling which often precedes shorting

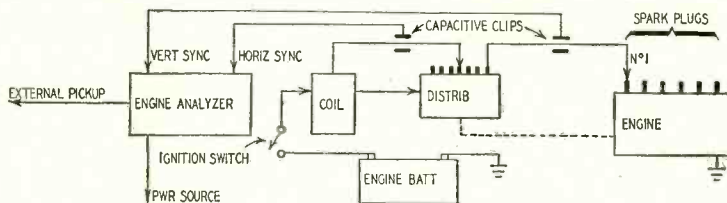

Block diagram of the cathode-ray analyzer installed on an engine.

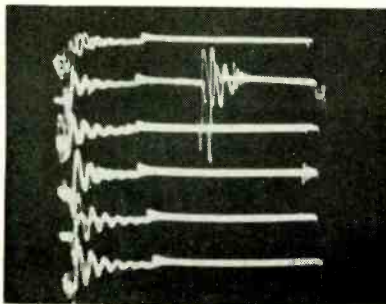

Fig. 11—Poor secondary voltage waveform caused by distributor point bounce.

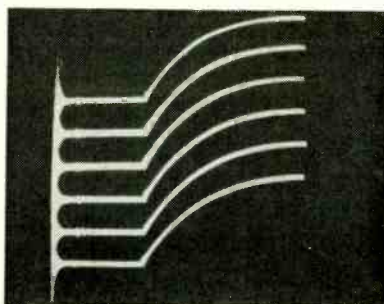

Fig. 12—Normal coil charging current.

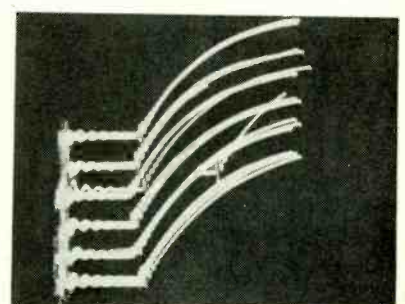

Fig. 13—Poor primary current waveform caused by distributor-point bounce.

by deposits on the porcelain. In this case spark plugs No. 5 (line 2), No. 6 (line 4) and No. 2 (line 5) show a shortened spark line which is also very distorted. This condition in an engine limits engine power and frequently does not become evident until full power is demanded from the engine.

Sometimes the distributor points may actually bounce open during the period that the coil is saturating before the spark. This is shown in Fig. 11 where a spark occurs during the dwell time on line 2. In this case the bounce produced a spark of low energy, insufficient to trigger the horizontal sweep of the analyzer. It did, however, cause a

severe engine roughness which would have been extremely difficult and time consuming to locate without the engine analyzer. Fig. 13 shows what happens to the primary coil current when the distributor points open accidentally during dwell, as compared to Fig. 12 which shows normal coil charging current.

Both Figs. 11 and 13 were exposed for two successive firings. The photograph in Fig. 13 was not taken at the same time as Fig. 11, but in this particular instance of malfunction the trouble showed itself frequently enough to make possible the photograph of two nearly identical events, once when

observing secondary voltage and once when observing primary current. Through the use of the engine analyzer, the mechanic was immediately led to finding the cause of the distributor-point bounce and the trouble was traced to a worn distributor drive gear. Replacement of the faulty component corrected the poor performance of the engine.

Under a recent licensing agreement Du Mont Laboratories will manufacture and sell the instrument, known as the Type 901 Cathode-Ray Engine Analyzer. Du Mont expects to market the analyzer on a regional basis, beginning with the New York area. **END**

## SEARCHING FOR OIL with

*Exploring for underground deposits with seismic waves*

# ELECTRONICS

By JAMES A. McROBERTS

**S**EISMIC WAVE (artificial earthquake) exploration for new underground oil deposits is a little-known field to many electronic technicians. However, many skilled technical workers manufacture, operate and service seismic electronic equipment all over the world. Excepting its peculiar language, this apparatus is easier to understand than an ordinary radio set. For example, a "geophone" (Fig. 1) acts like and is made similar to a dynamic phonograph pickup. Twelve such geophones pick up ground vibrations and feed 12 amplifiers, each of which drives recording elements to produce the 12 separate traces of Fig. 2 (an actual seismogram).

Many such seismograms, together with other information, produce a geological map of some locality where wells are to be drilled in the hope of finding oil. If the locality has not been previously drilled for oil, this hope is fulfilled about once in eight trials. To understand the reasons for so many failures, to comprehend the electronic part (the major part) of a seismic exploring system and what such a system accomplishes, we must turn to the fascinating story of the shape of the Earth and, more important to this discussion, the underground shape.

### Structure of the Earth

Geology tells the story that the outer crust of our Earth has changed many, many times in the past billions of years. This crust—10 or so miles thick—has wrinkled many times with advancing age. The outermost parts of the wrinkles are our present-day moun-

tains; the innermost are valleys filled with ocean water. Down through the ages, some wrinkles have been removed, valleys have become mountains or vice versa. In this wrinkling process the U. S. A. has been out of the water and under it numerous times, as has the rest of the world. Whenever the surface of the ground has been covered by water, mud and other deposits have settled. These sediments usually come from some part of the Earth above water. Most of these sediments turn into rock.

The climate of our Earth was much warmer in its past history than today. Partly due to this, great forests and jungles of plant life covered many parts of the Earth's surface. Eventually these plants, trees, etc. died—partly due to change of climate—and

their remains (dead tree trunks, for example) were buried along with other sedimentary deposits. These dead plant remains or carcasses are said to be the source of our coal. Most geologists believe that some of the dead plant life became oil. To be accessible, these deposits must be available from dry land—not under the ocean, except in very limited areas. All exploration for oil is made in localities having sedimentary rocks or near such rocks.

Fig. 3 represents a cross-section of some part of the Earth's crust to illustrate how the shape or structure of the rock layers—sedimentary rocks are usually deposited in layers—may differ from the surface of the Earth. Note how the surface level varies. In places there are mountains; elsewhere there are areas that have been eaten away by running water. By this erosion, "old" mountains become rounded; new mountains are sharp cornered. Our Rocky Mountains are new or young mountains.

Consider the rock layers below ground. They do not follow the shape of the surface of the ground; their structure is different. Note what seems to be an old ground surface at layer D (Fig. 3) which was dropped below water and had sedimentary layers A, B, C deposited on it. Another action that shifts rock layers is called "faulting." Faults are simply rock layers that have broken and shifted. Sometimes this is due to weight; sometimes to bending back and forth.

Almost all crude or natural oil floats on water. Underground oil floats on water too—on underground water. If

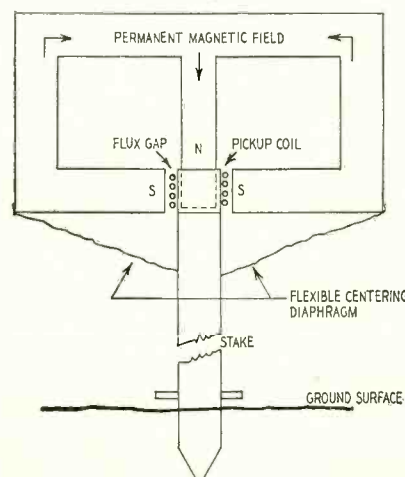

Fig. 1—Diagram of geophone pickup.

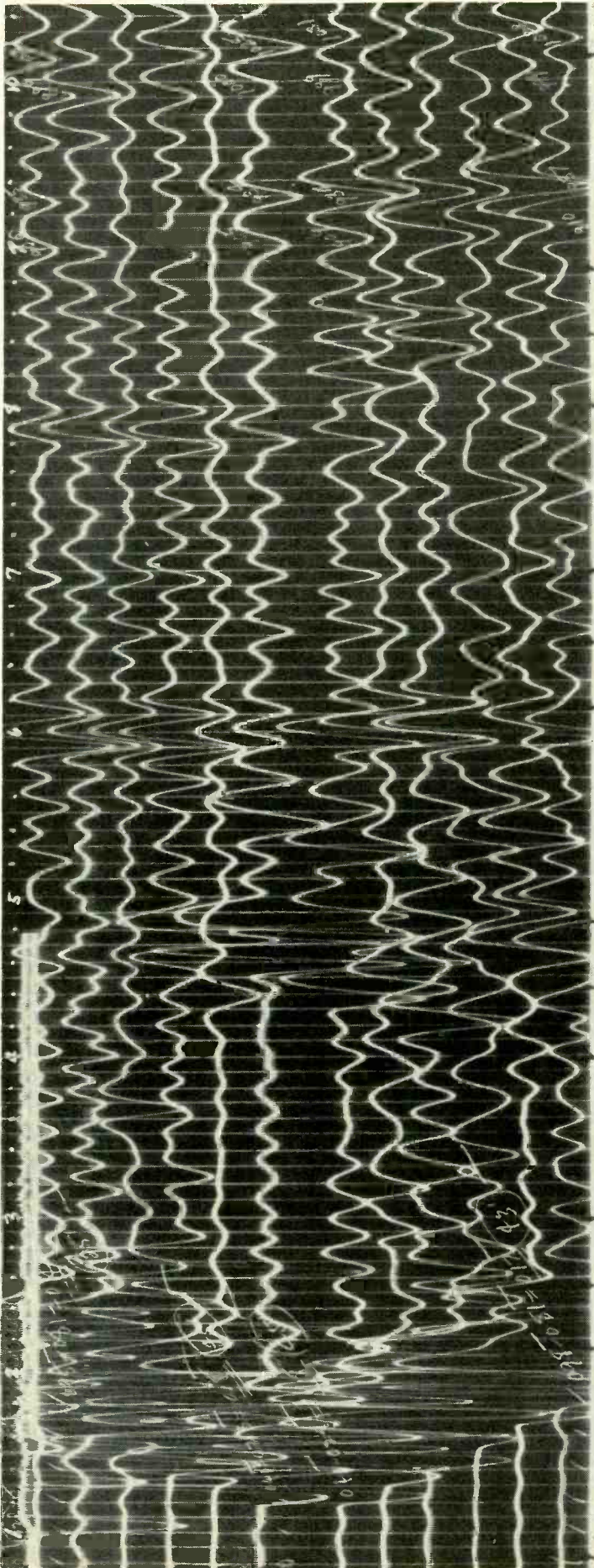

Fig. 2—Typical seismic recording.

not restrained, the oil eventually reaches the surface of the ground. Underground oil and water do not ordinarily exist as large lakes or pools, but in spongelike pore holes of rock. Most of the oil fields of the world have their oil stored in these rock pores or holes which average about 50 to the inch. Some rocks do not have big pores and may not pass oil toward the surface. The oil collects underneath these so-called cap rocks at points where there is a fold pointing upward (an "anticlinal" fold). Such a fold with a possible oil deposit under cap rock D is shown in Fig. 3.

Another common trap for oil is a fault in combination with a cap rock as shown in the center of Fig. 3. These are known as structural traps for oil and the location of such traps is the primary purpose of seismic and all other information used in making the geological map to locate oil.

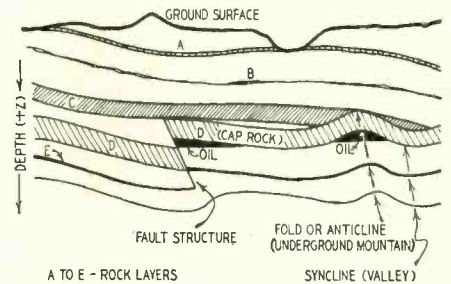

Fig. 3—Cross-sectional view shows structure of the Earth's crust.

**Seismic exploration systems**

You probably know how depth is measured by a sound wave sent from a shipboard sound source and reflected from the ocean bottom. The time taken for the round trip indicates the depth of the ocean. In oil exploration, an explosion of blasting gelatine produces seismic waves whose frequencies are from about 10 to several hundred cycles. The differences in time of travel of a seismic wave tell how far down some reflecting rock layer is from the surface. The geologist wants to know how deep below some level—sea level, for example—several rock layers are.

From the explosion seismic waves travel in all directions. Those going downward hit a layer that reflects a part and transmits a part of the seismic wave. The reflected part returns to the surface and is picked up, amplified and recorded. The transmitted portion goes still farther, hits another layer with partial reflection and partial transmission, and the reflected portion returns surfaceward to be partially reflected and transmitted at the first rock layer again. This last transmitted portion travels to the surface for pickup and recording. Thus, a number of rock layers give us information in seismic work. Fig. 4 is a typical layout of a "reflection" seismic system so called since it deals with seismic-wave reflections.

In the system of Fig. 4 an arbitrary

line is laid out across the area to be surveyed by the seismic method. It is labeled X and is the surface of the

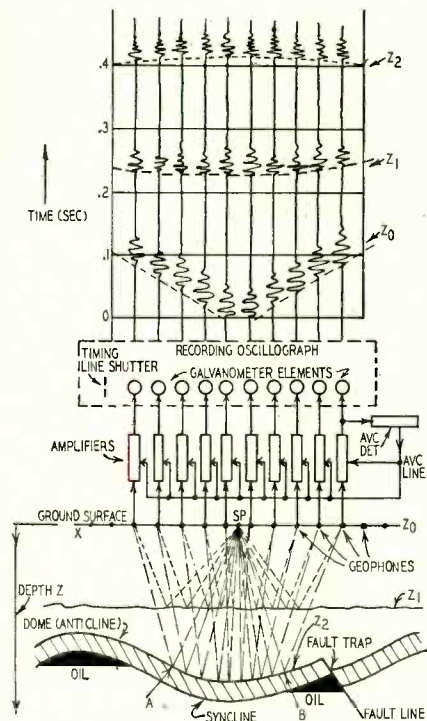

Fig. 4—Diagram shows relation of the Earth and components of seismic system.

ground. Seismic people call depth below ground Z. Along X pickup units are placed to receive the reflected seismic waves which are fed into channel amplifiers. Each amplifier feeds or drives a recording element in a recording oscillograph, so the trace on the final record is really an amplified version of what the geophone pickup of that channel receives. Usually the geophones are placed at 200-foot intervals on either side of the point (SP) where the explosive is set off. Such a layout is called a double spread. If all detectors are on one side of the shot point, it is a single spread.

Seismic waves generated at point SP travel in all directions with a uniform speed so long as the physical properties of the uppermost rock layer remain constant. In traveling along the surface of the ground, the seismic waves pass the detectors at different times causing (through pickup—amplification—recording) the different starting times  $Z_0$  of the seismic waveforms on the moving seismic record. Seismic waves traveling downward strike layer  $Z_1$  with some reflection due to different physical characteristics which comes back to be recorded as  $Z_1$  on the moving seismic record. Of the seismic energy hitting the  $Z_1$  layer or rock bed, some is transmitted downward to hit  $Z_2$  and is partially transmitted and partially reflected. The partially reflected wave reaches the surface to form the "reflection incident" labeled  $Z_2$  in Fig. 4. Thus the time for a seismic wave to travel to some reflecting (usually partially reflecting) rock layer becomes

a permanent record of that wave.

Now examine layer Z. Note the upward curve which indicates the presence of that part of the syncline between points A and B on the diagram. You will see that the time needed by a seismic wave to reach the bottom of the syncline is greater than the time to reach an adjacent dome, or anticline, or other higher point. This shows up as a different time for the same reflection incident on seismic records taken over the dome or fold and over the valley or syncline.

Observe the "trap" structure of the fault to the right bottom of Fig. 4. A sharp drop on the same record or an adjacent record will be seen in the reflection incident for a fault as shown on  $Z_2$ , in this instance contrasted to the relatively even reflection incident taken over the syncline in the middle of Fig. 4. This is how reflection seismographs help find structures which may trap oil.

Only areas with good prospects as to oil source material and good structural features are drilled for oil. If there is no structure or seismic evidence of structure, the present use of the seismic exploration system fails. I have taken seismograms from areas unknown to me and have been able to detect on them the presence of oil regardless of structure with a .500 batting average and have foretold with accuracy the depth of producing areas not given in oil drilling statistics.

#### The electronic equipment

The amplifiers are easy—they must have fairly faithful reproduction from about 10 to about 1,000 cycles, so conventional audio amplifiers with low-frequency compensation are used. Each of the amplifiers has its own screw-driver controls, a volume control and "frequency" controls which are ordinary tone controls. Prior to seismic runs, the gain of the individual channels is equalized with a constant signal input from a test record. Special test circuits tell the operator of failures. An automatic gain control is a recent-day innovation because of decreasing strength of the reflected seismic energy from great depths (it is really an a.v.c. with a large time constant due to a low-frequency input). The time constant is too low however for peak detection. The a.v.c. is fed to the different amplifiers through a decoupling network although its input is from only one or two of these.

The geophone is exactly like a dynamic phonograph pickup except that the needle is replaced by a "spike" (Fig. 1) to be pushed into the ground. The seismic energy vibrates the spike and moves the pickup coil in the magnetic field and thereby develops a voltage corresponding to movement of the ground. This forms the input signal to the amplifier.

Recording galvanometer elements work like d.c. meters; a variable current passes through a coil in a magnetic

field, turning the coil. Instead of a pointer, the element rotates a tiny mirror which moves a beam of light focused on it. This beam of light is arranged to hit a special moving photographic paper. The up-and-down motion of the beam of light is thus spread out—ordinarily at 10 inches per second. The recording oscillograph has one element for each channel, but a common magnetic field for up to 36 elements. Timing lines are put on the sensitive paper by a rotating slit making one vertical line every 1/100 second and a heavier one every tenth line or 1/10 second—these are numbered later by hand. The sensitive paper and the elements are in a light-tight box and the paper is processed photographically.

Older seismic equipment used a land telephone line to tell the operator in the recording truck to start the recorder which automatically connected the telephone line. The operation of the blasting machine transmitted over the telephone link momentarily broke or interrupted the trace, making a record of the time of the explosion.

#### Refraction system

In this setup the equipment does not change; however, the detector spacing does, being much greater than the 200 feet customarily used in reflection work. Geophone spreads of up to several miles are common and are all on one side of the shot point. In refraction work, only the time to reach the detector is of interest and subsequent events as in reflection work are ignored. Refraction work was used to find changes of speed in material near the surface which differ materially from the surrounding material and would cause an appreciable difference in the time of arrival of a seismic wave. By the refraction method, some salt domes in the Southwest have been discovered. These salt domes have deposits of oil around their sides.

The length of the record in reflection work is about 2½ to 3 feet long. This length corresponds to a time of travel of the seismic wave of about 2.5 seconds both down and up. The speed of seismic waves increase with depth. Usually 2 seconds of travel represent a depth of about 12,000 feet but as the speed is variable with different areas this is only a rough guide. I have been able to discern the difference between oil and no oil on seismic records (reflection) at 9,700 feet with an error of 100 feet—less than the error with which the depth of a drilled well can be measured!

Refraction records are somewhat longer. The usual length is about 4 feet due to the longer detector spacings. The refraction method has fallen into disuse in the last 10 years with the reflection method being used almost exclusively in seismic exploration for oil. Despite the fact that its current use is to locate structural traps for possible oil deposits, it is the most reliable of all "finding" methods to date. END

# Transistorized

*All-semiconductor unit  
is sensitive and fast-  
operating*

## Photocell

# ALARM

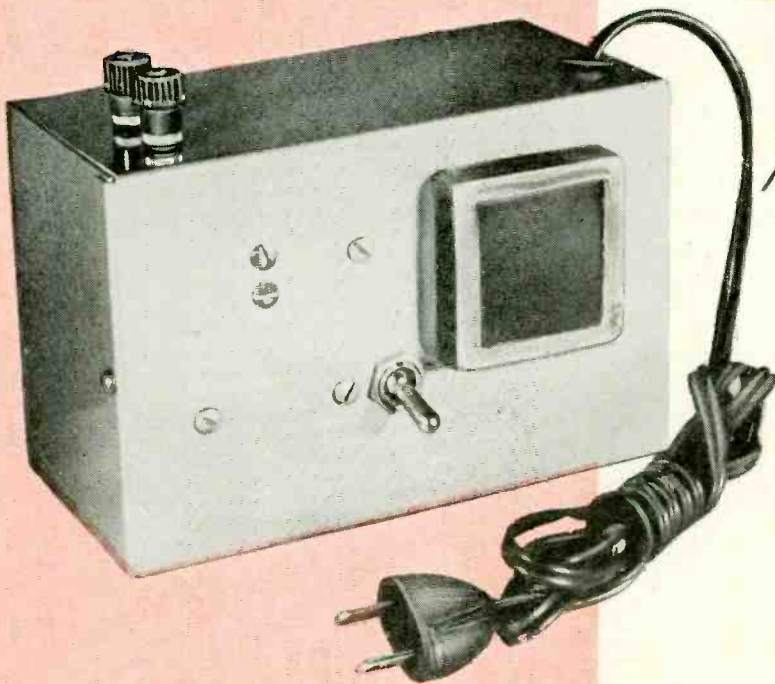

Transistorized intruder alarm.

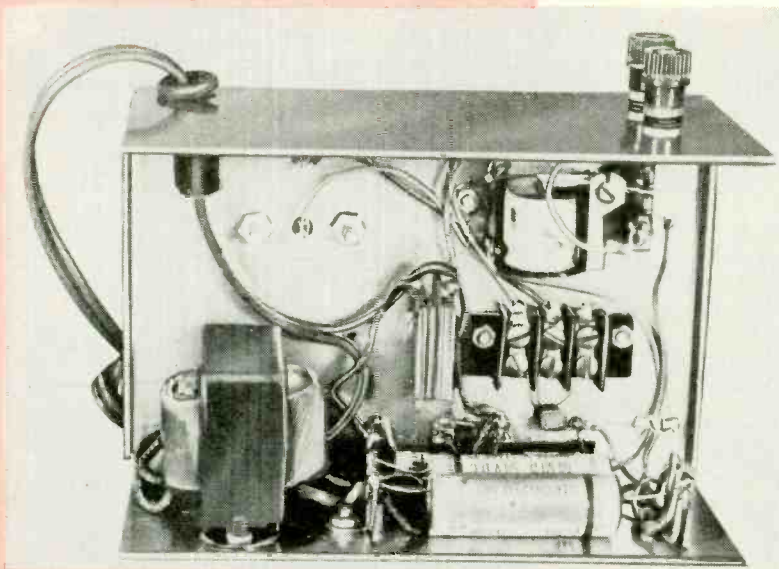

Components layout in the equipment.

By RUFUS P. TURNER\*

**T**HROUGH the use of one low-priced transistor, a photoelectric relay which may be used as an intruder alarm and for several other purposes can be built for exceptionally low-current operation. There are no tubes to be replaced (transistor life is tremendous) and only the tiniest amount of heat is generated.

The simple circuit is shown in the diagram. A self-generating photocell is connected to the input of a CK722 transistor. A milliampere type d.c. relay is connected to the transistor output. The d.c. operating voltage for the transistor is furnished by a simple voltage doubler composed of a 6.3-volt filament transformer, two 1N34 germanium diodes (D1 and D2) and two 50- $\mu$ f electrolytic capacitors (C1 and C2). This simple power supply circuit delivers 17.5 volts when operated from a 115-volt power line.

Normally, the d.c. output current of the transistor, only a few microamperes, is too low to operate the relay through whose coil it flows. But when the photocell is illuminated, the direct current it generates flows into the transistor input and causes an amplified transistor output current high enough to energize the relay. If the cell is then darkened, as it will be when a person or object passes between it and the source of light, the collector output current decreases and the relay is de-energized.

\*Author, *Transistors, Theory and Practice*.



The normally closed contact of the relay is used as indicated in the diagram. As long as the photocell is illuminated the relay armature is pulled away from this contact and the circuit connection to output terminal A is broken. When the cell is darkened the armature returns to the normally closed contact and closes the circuit. This applies 6.3 volts a.c. from the transformer to the output terminals, and this voltage may be used to operate a bell, horn or other alarm device or to start the operation of an external circuit.

The circuit is fast-operating and will work with the cell illuminated either by an incandescent bulb or by daylight. If the distance between a lamp bulb and the photocell is greater than about 3 feet (the width of most residence doors), a lens may be needed in front of the lamp or cell for focusing the light rays.

Transistor and diode life is almost limitless with the small amounts of current flowing through them. Since there are no tube filaments to heat slowly, the circuit is ready for instant

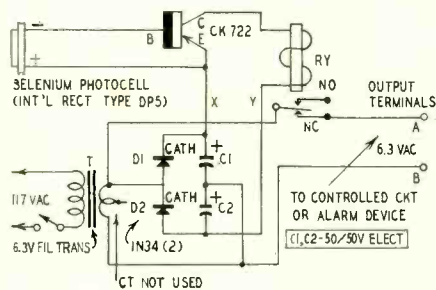

Schematic of the transistorized alarm.

operation. The amount of power taken from the 115-volt line is less than that used by an electric clock. Operating expense thus is negligible.

Battery operation may be used if desired. Simply omit the power supply components (C1, C2, D1, D2 and T) and connect a single 22.5-volt battery to leads X and Y. Connect the positive terminal of the battery to X and the negative terminal to Y. Wire the on-off switch in series with lead Y and the battery. The length of service will depend upon battery size, being longest for larger batteries.

The photocell used is an International Rectifier Corp. type DP5. This unit has high d.c. output voltage for a given amount of illumination. However, any other type of self-generating cell can be used. Several models are found in the surplus market.

The d.c. relay is a Sigma type 4F. This unit normally closes on 1.6 ma but can be made to operate reliably on currents as low as 1 ma by unscrewing its pivot screw a small amount. Type 4F relays still may be found from time to time in the surplus market.

#### Construction

The photos show the construction of a burglar alarm. The unit is built

in an aluminum chassis box 6 inches long, 4 inches wide and 3 inches deep.

The photocell, relay, on-off switch and transistor socket are mounted on the rear of the front panel. The power supply components are mounted on the bottom, the output terminal binding posts on the top.

#### Parts for burglar alarm

2—50- $\mu$ f 50-volt electrolytic capacitors; 2—IN34 germanium diodes; 1—sensitive d.c. relay, approximately 1 ma (Sigma type 4F or equivalent); 1—CK722 transistor; 1—self-generating photocell; (International Rectifier Corp. type DP5 or equivalent); 1—s.p.s.t. switch; 1—filament transformer, 6.3 volts @ 1 amp (Merit P-2944 or equivalent); 1—line cord; 2—output terminals with insulating washers; 1—transistor socket or 3-terminal block (Cinch-Jones 3-141 or equivalent); 2—mounting strips; 1—cabinet, approximately 6 x 4 x 3 inches.

The transistor "socket" is a Cinch-Jones type 3-141 three-screw terminal block; the transistor pigtailed are fastened under its screws. This arrangement is better than soldering the transistor into the circuit since it removes the chance of heat damage. Also, the transistor can be removed easily for testing or for temporary use in experimental circuits when the burglar alarm is not needed.

The output binding posts are mount-

ed with insulating washers to prevent contact with the metal box. Neither is connected to the box.

Observe carefully the polarity of the diodes, electrolytic capacitors, photocell and transistor. Connect these components *exactly* as shown in Fig. 1.

After the wiring has been checked, the unit may be tested. Connect an a.c. voltmeter (or a buzzer or electric bell) to the output terminals. Place a lighted 60-watt lamp about 2 feet from the photocell. Plug the unit into the power line and close the switch. The meter should not read nor the bell sound. If either operates, move the lamp closer or adjust the relay pivot screw (to loosen the spring) until operation ceases. Now pass your hand between the light and the cell. If this causes the meter to read or the bell to sound, the device is ready for use.

This photoelectric alarm is satisfactory for any of the uses to which such a light-operated relay can be applied—counting objects, opening doors, stopping a machine when a hand or arm approaches, turning lights on and off, etc. It operates quietly, without hum or chatter. Its light weight (2 pounds) makes it easy to install. END

## COMPACT GEIGER COUNTER

In keeping with the expanding demands in the field of uranium prospecting, a small Geiger counter capable of measuring tiny increases in radiation over normal background count has been introduced. The Ura-Finder (see photo) is powered by a small penlight cell. Extremely compact, the instrument is about the size of a pack of cigarettes. It is being marketed by El-Tronics, Philadelphia.

The operation of the Ura-Finder can be seen from the diagram. In this circuit the Geiger tube serves three purposes: it rectifies the several thousand

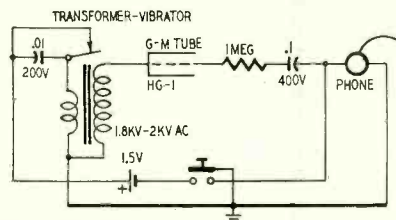

volts of a.c. from the transformer; it acts as a voltage regulator and is the radiation-sensitive device.

The transformer-vibrator (El-Tronics part VT-1) steps up the penlight-cell voltage to approximately 2,000. After rectification, a potential of 500 volts d.c. is applied to the Geiger tube.

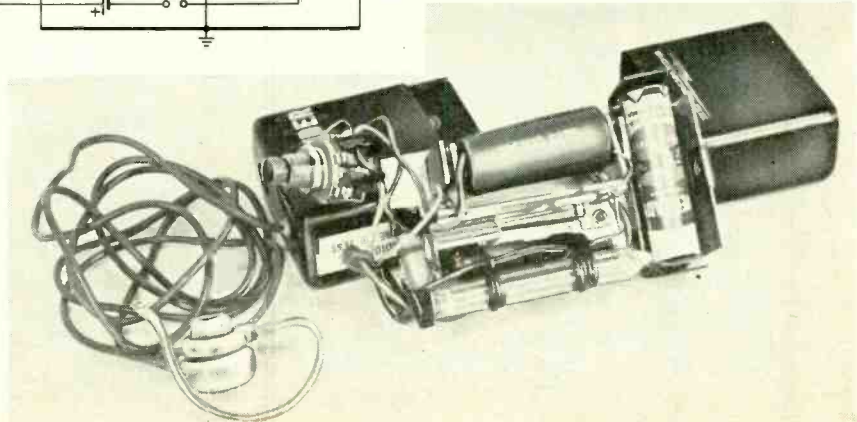

# HIGH-POWER

## williamson amplifier for

# HI-FI

*50-watt unit uses 6550 output tubes and larger output transformer*

By DAVID HAFLER\*

THE need for high-powered amplifiers for home reproduction is being accepted by a rapidly growing minority of audio enthusiasts. Many still feel that "10 watts is enough," but the author is a member of the group which believes that power capabilities above 25 watts are required to attain maximum fidelity. Extended listening tests indicate that high-powered amplifiers of about 50 watts are cleaner than low-powered 10-watt units, particularly in the bass region.

One disadvantage of high-powered amplifiers has been their cost. Now it is practical to build a Williamson type amplifier that delivers 50 watts of clean power at a cost only \$10 higher than either the 15-watt triode or 25-watt Ultra-Linear unit (assuming that top-grade transformers are used in these amplifiers). It is also feasible to convert existing Williamson amplifiers to high-powered use with a considerable

improvement in listening quality. This is made possible by the Tung-Sol 6550 tube, now commercially available.

The 6550 is a ruggedized beam-power tetrode with a total plate and screen dissipation rating of over 40 watts. It is an efficient tube with high-power sensitivity that offers high quality and high power without corresponding high cost. Tung-Sol suggests several types of operation ranging from 28 watts in triode connection to 100 watts as a tetrode with 600 volts on the plate. The triode connection does not take full advantage of the power-output capabilities of the tube and the 100-watt circuit requires a complicated and expensive power supply.

### Design considerations

Most Williamson amplifiers have power supplies which provide 425 to 450 volts at about 200 ma. These can be used with the 6550 operated with 450 volts on the plate and screen and

48 volts bias. The bias can be obtained from a 200-ohm cathode resistor adequately bypassed, but it is preferable to use fixed bias to make full use of the tube's capabilities. Fixed bias is obtained as shown in Fig. 1. An a.c. voltage divider consisting of a .05- $\mu$ f capacitor and 47,000-ohm resistor is placed across half of the high-voltage secondary of the power transformer. Its output is fed to two small selenium rectifiers—connected in series for an adequate voltage rating—and filtered by the 40- $\mu$ f electrolytic capacitor. The d.c. voltage divider consisting of the 10,000-ohm control and 15,000-ohm resistor proportions the voltage. The output bias is adjusted to the desired value with the BIAS control. To convert present amplifiers, the 10,000-ohm potentiometer can be inserted in the hole which previously held the bias balancing pot.

If the B plus voltage runs a full 450, for extra safety the conventional 5U4-G rectifier should be replaced with a 5U4-GB. This will lower the plate supply slightly (and keep it under 450 volts even if the line voltage is high) and will adequately handle the additional current drain of the 6550's which runs about 180 ma. It is not desirable to operate the 6550's with more than 450 volts, so the 5U4-GB is generally preferable.

The other basic change in circuitry lies in the output stage. The 6550's have the same basing arrangement as KT-66's or 5881's and, therefore, can be directly substituted. However, they require a different impedance match for optimum performance. This means that a different output transformer must be used. This is also necessary to handle the 50 watts which the converted circuit can provide.

Experiments with impedance matching showed that maximum power could be realized with a low plate-to-plate load of about 3,000 ohms and 40 volts bias. This condition resulted in excessive power dissipation in the tubes which could not be remedied by an increase in bias without a corresponding

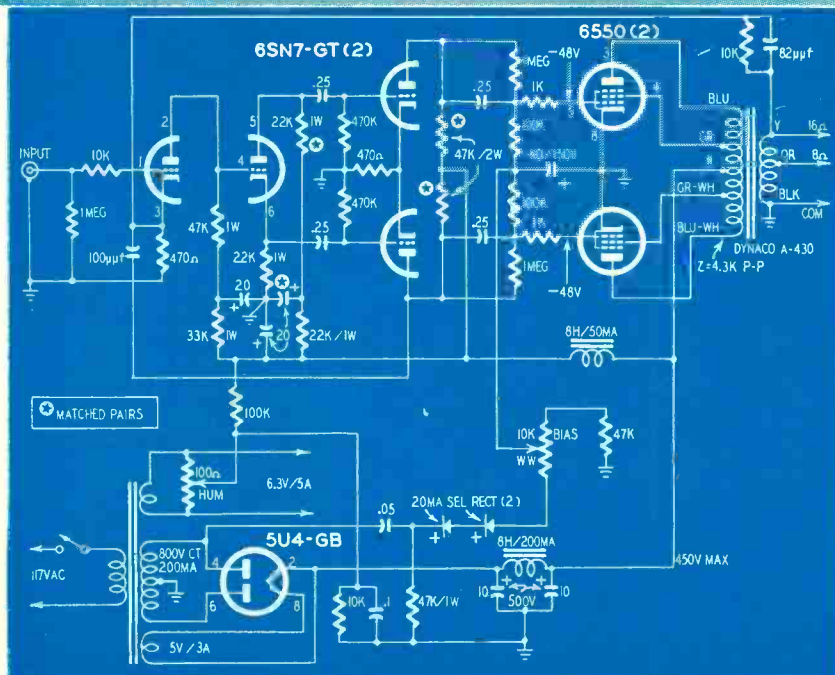
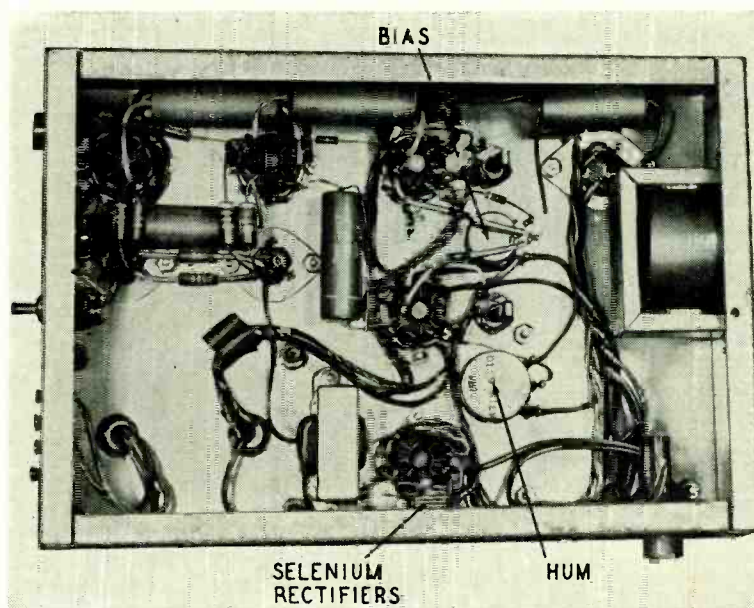
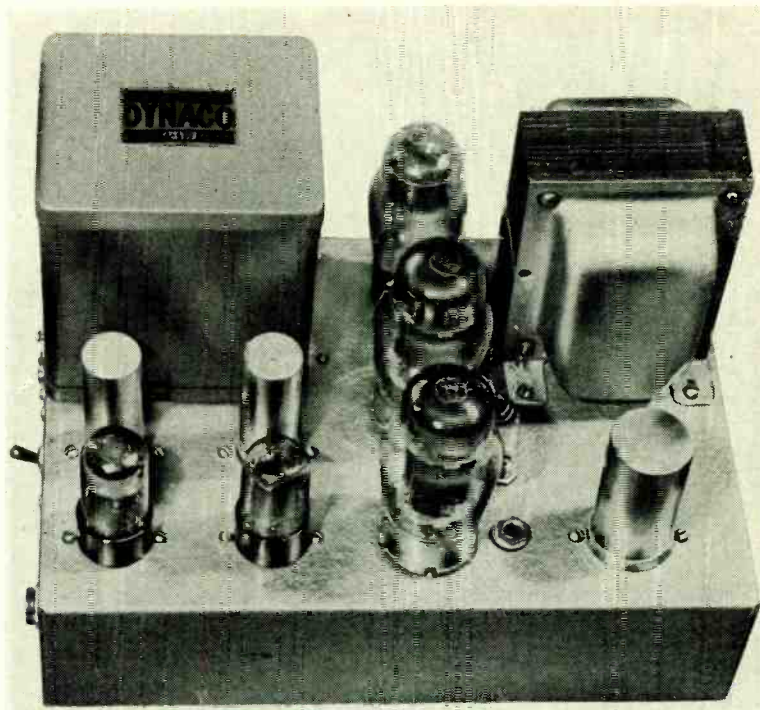

Fig. 1—Schematic diagram of the 50-watt modified Williamson amplifier.

Top view of the Ultra-Linear amplifier after conversion to 50-watt output.

Underchassis view after conversion. The jacks are for metering plate current.



increase in nonlinearity. Maximum linearity is attained with a plate-to-plate load between 4,000 and 4,500 ohms and 48 volts bias. This reduces maximum power from about 56 to 52 watts (depending on the supply voltages) but cuts the distortion below the 50-watt range to about one-half of what it is with the lower primary impedance.

On the basis of these considerations a transformer was designed with 4,300-ohm primary impedance and a *continuous* 50-watt rating for all frequencies from 20 cycles to 20 kc. This unit, the Dynaco A-430, has a bandwidth of from 6 cycles to over 60 kc  $\pm 1$  db to minimize phase shift over a band far in excess of the audio spectrum. Other transformers of comparable specification can be used if their design permits a satisfactory margin of stability under feedback conditions.

The circuit (Fig. 1) uses a screen tap to provide d.c. for the screens of the 6550's and a small degree of screen loading. Since the primary impedance was selected to furnish optimum linearity, the screen tap was not used for this purpose but to reduce the internal impedance of the tubes and provide suitable damping. The damping factor of the complete amplifier, after applying inverse feedback, is over 20—greater than normally found in high-fidelity equipment of this power bracket.

The final variation in the design from the original is a change in the phase characteristics to provide additional stability at both high and low frequencies. The lack of adequate stability was one of the serious weaknesses in quality of the basic Williamson design. Many of these amplifiers, whether home designed, kit assembled or commercially produced, had a tendency to motorboat at low frequencies or to oscillate above audibility when used on a loudspeaker load. They measured well on a resistive load but their listening performance was frequently marred by this instability under listening conditions.

The 0.25- $\mu$ f capacitors connected to the grids of the 6550's are bridged by

1-megohm resistors. At the very lowest frequencies, these reverse the phase shift introduced by the coupling capacitors, so the stage is direct-coupled for very low frequencies while capacitively coupled for higher frequencies. This reverse phase shift compensates some of the phase shift due to the 0.25- $\mu$ f coupling capacitors preceding the 6SN7-GT driver. The d.c. voltage reaching the grids through the 1-megohm resistors is compensated by adjusting the bias control.

Thus, the amplifier phase shift at certain low frequencies is due solely to the phase shift in the output transformer since the phase shifts due to the R-C networks are opposite in sign and cancel. The frequencies at which this effect takes place are in the 1- to 2-cycle range where the circuit would otherwise approach 180° of phase shift

with a tendency to motorboat when shock-excited. This type of phase correction eliminates *all* traces of low-frequency instability.

High-frequency phase correction is made by the capacitor across the feedback resistor and the capacitive internal feedback loop connected to the first cathode. This feedback loop is effective primarily at ultrasonic frequencies. The capacitor and feedback loop prevent ultrasonic oscillation or serious ringing whether the amplifier is used with resistive load, speaker load or open-circuited. In short, it is stable under any condition in which it would normally be used.

The underchassis photo shows the location of many components of our Williamson-type amplifier. The small filter choke next to the selenium rectifiers is not used in all models. The two

## AUDIO—HIGH FIDELITY

jacks, used for metering output cathode currents, are not shown on the diagram.

### Performance

The maximum power capability of the amplifier is determined largely by the effectiveness of the power supply. With the average supply used in Williamson amplifiers a power output slightly over 50 watts can be attained before the intermodulation distortion reaches 1% (based on 60 and 6,000 cycles mixed 4 to 1). If a power supply of better regulation is used, such as a pair of 5V4-G's in parallel with a choke-input filter, the power capability is increased to over 60 watts.

The distortion curve (Fig. 2) is based on a unit using a conventional 200-ma power supply with a single 5U4-GB rectifier. The combination gives less than the permissible 450 plate volts and at high output the B plus drops to about 400 volts. Even with these limitations, the distortion characteristics are excellent. At 35 watts, the IM distortion is still below 0.2%. At lower levels, distortion is below 0.1%. These figures are in sharp contrast to high-power amplifiers which depend on class-AB<sub>2</sub> or -B operation—either of these types of operation create minimum low-level dis-

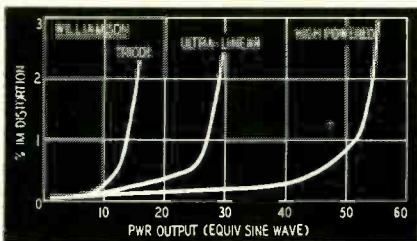

Fig. 2—Amplifier distortion curve.

tortion components of 0.25% or even higher.

Frequency response of the Williamson type circuit is generally outstanding and far in excess of the customary audio spectrum. The high-powered Williamson arrangement does not impair this and response is extended smoothly from below 10 cycles to over 100 kc with minor frequency discrimination. The peaks which normally indicate instability in many circuits are completely eliminated and the smooth extended bandpass permits excellent square-wave transmission from 20 cycles to 20 kc.

### Parts for high-power amplifier

**Resistors:** 2—470, 2—1,000, 3—10,000, 1—39,000, 3—100,000, 2—470,000 ohms, 3—1 megohm, 1/2 watt; 3—22,000, 1—33,000, 2—47,000, 1 watt; 2—47,000, 2 watts; 1—100-ohm potentiometer; 1—10,000-ohm potentiometer.

**Capacitors:** 1—50, 1—82 μf, mica; 1—.05, 1—0.1, 4—0.25 μf, 400 volts; 2—10 μf, 500 volts, electrolytic; 1—20 μf, 150 volts, 3—20 μf, 450 volts, electrolytic.

**Tubes:** 2—6SN7-GT, 2—6550, 1—5U4-GB.

**Transformers and chokes:** 1—output transformer, primary impedance 4,300 ohms plate to plate, secondary impedance 8 and 16 ohms (Dynaco A-430 or equivalent. Acrosound's TO 330 is a very close equivalent; Stancor is bringing out an equivalent for use with 6550's.); 1—power transformer, 800 volts ct @ 200 ma, 5 volts @ 3 amps, 6.3 volts @ 5 amps; 1—choke, 8 henries @ 200 ma; 1—choke, 8 henries @ 50 ma.

**Miscellaneous:** 2—selenium rectifiers, 20 ma; 5—octal sockets; 1—line cord; 1—input jack; 1—output terminal.

The power rating of the output transformer permits full power at all audio frequencies without visible distortion or attenuation of the waveform as viewed on a scope. Many power ratings indicate that amplifier response is flat at rated power but they ignore distortion at frequency extremes. In this design high-powered response is essentially distortion-free, indicating that the intermodulation products must be small for any combination of frequencies within the 20-cycle to 20-kc spectrum.

The final and most important test of an amplifier is the listening test. The 6550 passes this with flying colors and has amazed many who felt that there was no more room for improvement of audio power amplifiers. The high power

capacity provides clean sound through the heaviest passages. Some muddiness which had been attributed to the program material vanished when the high-powered amplifier was substituted for a 25-watt Ultra-Linear amplifier.

The improved sound quality is due in part to the extra power handling; in part to the wide stability margin. This insures instantaneous recovery on percussive sounds and translucent, smooth listening on high-frequency string and wind instruments. Small transient sounds such as tambourines assume a different spatial perspective, possibly because the low phase shift does not disturb the harmonic pattern of complex nonrepetitive tones. The total effect is greater naturalness and less impression of reproduced sound. END

## SOUND SELLING

By ROBERT E. RIDDLE

HERE is a copy of a letter—the signature has been changed—that recently came to my attention:

"Sir,

Could you, of Midland Engineering Company, fix me up with an unusual method of advertising my business?

I have signs of every description, both inside and outside, as well as display ads in the newspaper. I want a permanent, cheap means of advertising.

Respectfully,

Richard Roe"

The writer didn't say what kind of business he was running or its location. I was about to file it in the wastebasket, when the clock on the next desk started tolling the time. Then it hit me! Why not a chiming clock that could be heard over a wide area?

One of the fellows plays an electric guitar in the company dance band. Fortunately this happened to be their day to rehearse.

I removed the pickup from the guitar, fastened it to the side of the clock, plugged in the amplifier, turned the amplifier volume on full and sat back.

It wasn't long coming. Instead of the soft mellow chime, there was the thunderous roar of a gigantic gong. Turning the gain down I again restored the soft mellow chime, but with enough volume so that it could be heard over a radius of several blocks.

I had the technicians rig up a similar unit (see diagram) and install it on the front of the department store next door. At the end of a week the manager told us that business that week was a good 40% over the same period a year ago.

The only modification we made in the unit was to use outside speaker horns and hook the amplifier to a time clock that shut it off at a few minutes past midnight and on again about five in the morning.

To get the correct time we used a shortwave radio tuned to WWV at 2.5, 5, 10, 15 and 20 mc, and set the chime clock by this at least once a day.

WWV may be identified by a tone signal and a beat, similar to the ticking of a clock. Every 4 minutes the tone stops and a message is sent out in Morse code, a voice announces the time, another message in code follows, then the tone returns on the exact 5-minute mark on the clock at the U. S. Bureau of Standards' Naval Observatory at Wash-

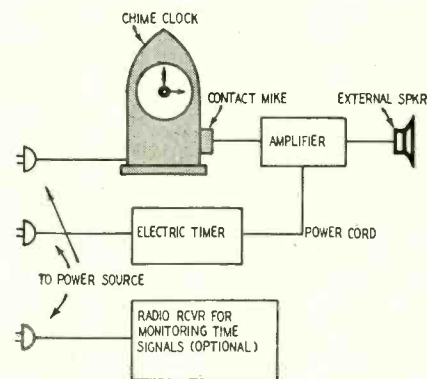

ington, D. C. All time is given in Eastern standard time. Compute the time by subtracting one, two or three hours, depending on which time zone you happen to live in.

If you don't want to go to the expense of getting a shortwave radio you can get the correct time by calling your local Western Union office, telephone company or railroad station.

Remember, when you broadcast the time, people want the right time, not just any time. Inaccurate time will reflect on your business as much as if you had given shoddy service or sold inferior merchandise. END

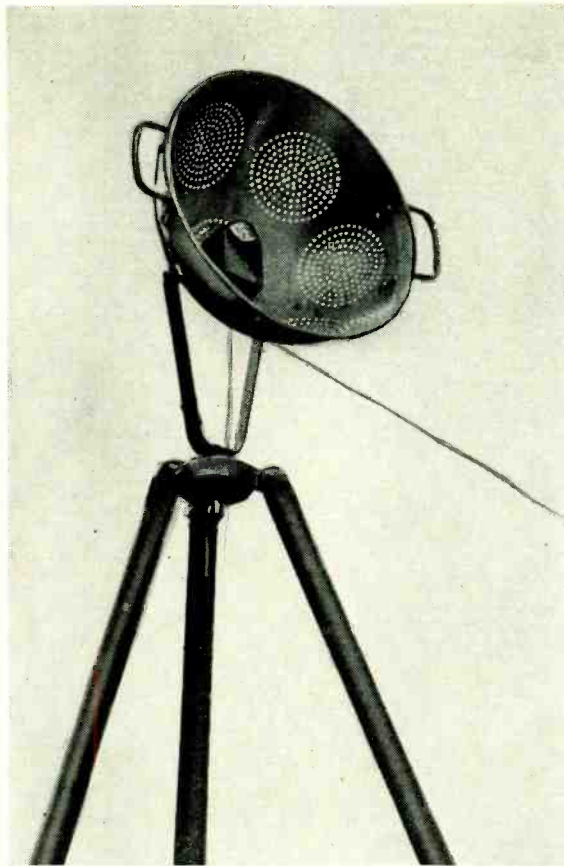

The preamp mounted in a colander.

# Remote Transistor Preamp

*Self-powered unit is versatile listening-in device*

By EDWARD M. NOLL

THE transistor can be used effectively in a remote preamplifier, a self-powered unit constructed as a lightweight, compact gain stage for a microphone. A very inexpensive two-wire audio cable or 300-ohm lead-in will carry the signal with little loss (Fig. 1). We have used over 250 feet of transmission line successfully and there is no reason why lengths up to 1,000 feet cannot be used when there is adequate audio gain at the terminating amplifier.



Fig. 1—Cable and terminal units.

For our needs the terminating unit was a tape recorder, though it could just as well be any type of recorder—tape, wire or record. The termination could also be the phono input of a high-fidelity installation, radio, television, public address system, etc. In our particular application we used the transistor amplifier (see photo) and tape recorder for some amateur tape recording of wild bird songs. As shown in the photograph the amplifier was mounted in a large colander that can be purchased wherever kitchen utensils are sold. Thus the pickup characteristic was more directional and background noises were reduced. In addition to a hole drilled in the colander to mount the preamp, two more were made to insert a small U bolt (such as those used to mount u.h.f. antennas to masts) so the

unit could be fastened to a mast, pole, tree limb, etc.

The transistor amplifier (Fig. 2) is a basic grounded-emitter circuit with a stabilizing emitter resistor. The transistor stage operates at a medium input impedance to provide a suitable termination for a small crystal microphone cartridge. The degeneration resistor also minimizes overload when the sound level is high. The crystal microphone cartridge is cemented to one side of the case.

The battery is clip-fastened to one side of a channel-lock type of case (see photo). All components, including battery and transistor, are soldered and mounted firmly to permit rough han-

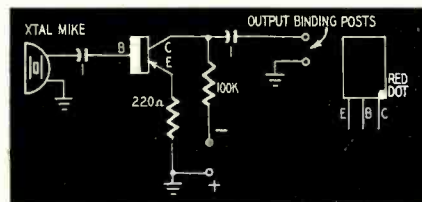

Fig. 2—Schematic of transistor preamp.

dling in the field. Rugged binding posts permit a firm attachment of the audio line to withstand considerable tugging.

The output impedance of the grounded-emitter transistor stage is high enough to provide good gain and low enough to permit driving a long length of cable without serious high-audio-frequency loss. Inasmuch as a battery powers the amplifier, there is no hum pickup. The signal is therefore amplified before it reaches the line and possible

hum pickup. Hum does become a problem when using long lengths of line, a problem overcome rather easily.

In our application a very inexpensive and, therefore, expendable audio cable is used. After one day of wood tangles and dampness we prefer to discard the line and start with new line on the next field trip. It is easier than trying to protect high-quality shielded line.

Lack of shielding does give us hum pickup at times in the vicinity of power lines. When hum level is high, we drive a 3-foot metal stake into the ground (Fig. 3). As short a lead as possible is then run between the ground terminal of the transistor amplifier and the metal stake. For a severe case of hum an intermediate stake can be used and connected to the ground wire of the cable. When used indoors, hum can be reduced by finding a good grounding spot as near the amplifier as possible.

With the availability of lower-priced

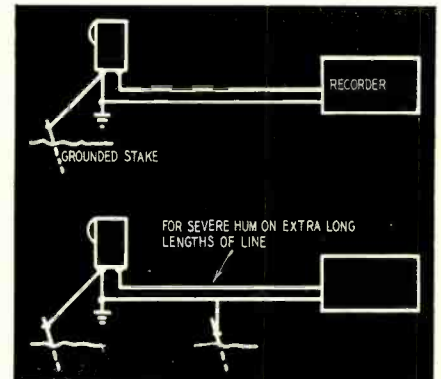
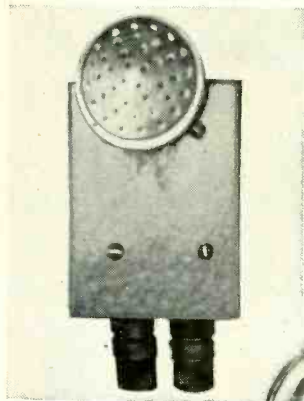

Fig. 3—Connections for hum reduction.

## AUDIO—HIGH FIDELITY



The transistor pick-up—the crystal microphone is cemented to the case.

An internal view of the preamplifier.

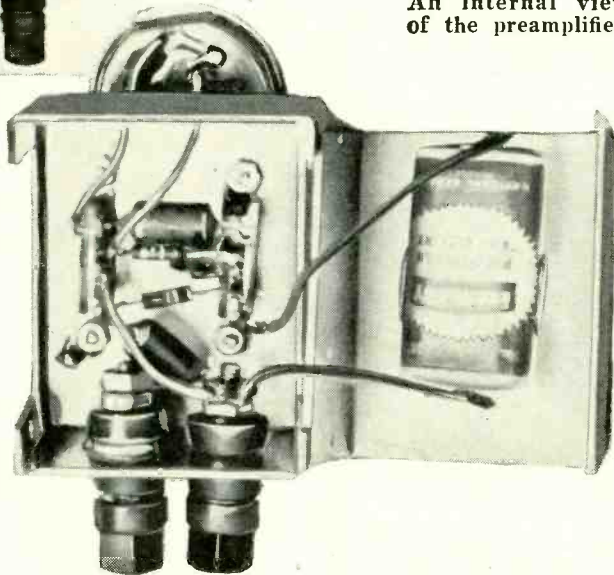

transistor transformers, it is economical to use low-impedance transformer coupling (Fig. 4). This helps minimize hum and noise pickup by the long length of line between the remote amplifier and the input of the amplifier or recorder.

### Remote-amplifier applications

A remote amplifier has numerous applications. It can be used for recording all types of sounds. It is excellent for picking up crowd noises, traffic sounds, aircraft, animals, locomotives, etc. If you are trying to build up a library of sounds, a simple remote amplifier is most helpful. A transistorized unit permits you to position your microphone at a site inconvenient to an a.c. outlet such as in woods, open fields, athletic fields and rooftops.

There are also many listening-in applications for a remote transistor amplifier. In this service the transistor

preamp can be used to supply a signal to any type radio or television set with a phono input. Thus it can be used as a baby sitter, intruder-warning device, one-way intercom, etc. It is convenient because it can be moved about, indoors or outdoors, without regard to nearness of an a.c. outlet. Long lengths of line can be attached, permitting wide separation between the microphone and listening receiver.

The transistor unit can serve as a remote microphone for a high-fidelity installation or public-address system. In PA work two or three of these units can feed signals to an audio mixer. Thus, a number of widely separated pickup points can supply information to a single audio control center. Remote pickup points can be planned and shifted without regard to separation.

The transistor preamp can be tested by connecting its output to the vertical input of an oscilloscope. If you whistle a reasonably pure tone into the microphone, you can observe its sinusoidal makeup on the scope screen. This waveform should not be distorted until you whistle loudly very close to the microphone. Then the waveform will flatten off, indicating an overload of the transistor amplifier.

If the amount of overload is too great for close-in use of the microphone, it can be reduced by increasing the value of the emitter resistor. For our application we desired the utmost sensitivity, realizing the sounds to be collected would in general be well separated from the microphone.

END

### Parts for transistor amplifier

1—220, 1—100,000 ohms, 1/2-watt resistors; 2—1- $\mu$ f capacitors, metalized tubulars; 1—CK722 transistor; 1—crystal microphone cartridge; 1—22.5-volt battery (Eveready 412 or equivalent); 2—binding posts (Superior or equivalent); 1—box, 2 3/4 x 2 1/8 x 1 1/8 inches (Bud Minibox CU2100 or equivalent); 2—terminal strips.

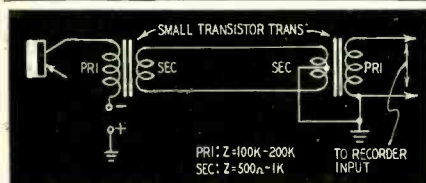

Fig. 4—Using transformer coupling.

## Add Bias-Erase Indicator to Tape Recorder

HAVE you ever tried to record an important event only to find that upon playing the tape back it had low level and was very distorted in spite of the fact that the program sounded normal in the monitor and the recording-level indicator showed proper setting of the gain control?

This was most likely caused by failure of the high-frequency bias and erase oscillator. A simple but effective precaution is to add a high-frequency

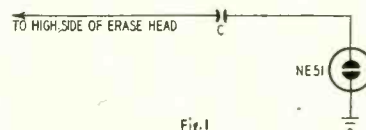

Fig. 1

bias indicator to your tape recorder at a cost of less than a dollar.

Figs. 1 and 2 show the circuits that can be added to almost any tape recorder. The NE51 neon lamp indicates the output of the bias oscillator. Cou-

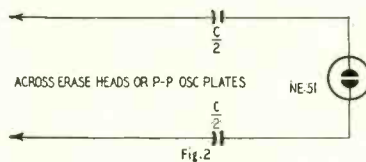

Fig. 2

pling capacitor C should be as small as possible while still keeping the neon lamp ionized. I used a 10- $\mu$ f unit on a Pentron 9T3C. Values as high as 50  $\mu$ f may be necessary on other tape recorders. The leads to C and the neon lamp should be as short as possible. Fig. 1 is used when one side of the erase head is grounded, Fig. 2 when both sides of the erase head are balanced to ground.

If the a.c. voltage across the erase head is not high enough—65 or more—to ionize the neon lamp, C should be connected to the plate or plates of the bias oscillator tube. Here again Fig. 1 is used with single-ended oscillators and Fig. 2 with push-pull units.

In addition to indicating bias failure, the neon lamp will also show when the tape machine is set for recording, helping to prevent any accidental erasure of tapes intended for playback.

A few of the popular tape recorders are listed below for balanced or unbalanced erase circuits.

### UNBALANCED

Dukane	11A55FF, 11B55
Masco	52, 52C, 52CR, 52L, 52LR, 52R
Pentron	9T3C
Reverse	T-70153, T-70157, T-70163, T-70167, T-70253, T-70257, T-70263, T-70267, T-77153, T-77157, T-77163, T-77167, T-77253, T-77257, T-77263, T-77267
Tapemaster	PT125 unbalanced head only

### BALANCED

Brush	BK-437, BK-437S, BK-439, BK-441, BK-442, BK-443P
Pentron	PRE-7
Tapemaster	PT125 balanced oscillator only

—Frank J. DiElsi

# TREMOLO

where you want it...

Amplitude modulator applies tremolo selectively

By TOM JASKI

THE high cost and tremendous space requirements of a pipe organ, the king of musical instruments, have inspired a rash of more or less successful electronic organs in the past 20 years. Some give a fair imitation of the grand musical effects of well built pipes, although the trained ear would not be fooled for long.

For many electronic organ builders it has been more attractive to provide their instruments with a great variety of sounds, frequently imitating instruments such as violins, clarinets, oboes, etc., rather than copying the organ-pipe representation of these sound characters. Some organ pipes such as the harmonic flute, viole celeste and bourdon in the higher-pitch ranges are almost impossible to reproduce. In some cases it's a lot easier to reproduce the sounds made by the original instruments. Acoustic coupling enters into the picture, for a moving column of air is an entirely different thing from an almost flat diaphragm transducer.

It is probably due to the attempts to reproduce music from instruments that almost universally a *vibrato* has been adopted for electronic organs, a characteristic never found in a pipe organ. That and economics, although some manufacturers such as Allen with the whirling speakers, will spend a good deal of money on their vibrato. The fact that a tab or stop reads *tremolo* or *tremulant* does not mean that it is necessarily so.

It is not the purpose of this article to discuss the merits of vibrato vs. tremolo. However, if you are sensitive to the thought that perhaps Bach and

Mendelssohn may be turning in their graves when they hear, respectively, some of their chorale preludes and some of the slow movements of an organ sonata played with a juicy vibrato, you may enjoy the thought that a simple inexpensive electronic tremolo is at hand.

Vibrato is produced by varying the pitch or frequency of a note, as the violinist does by wagging his finger on

the string. In electronic organs it is most frequently produced by introducing a variation in the plate supply to the oscillators.

Tremolo consists solely of an amplitude variation and, in a pipe organ, is produced by mechanically driven bellows which modulate the air supply to the pipes. The tremolo in a pipe organ is almost never severe enough to cause Doppler side effects; when it is the result is rather horrible because the pipes will be for fractions of a second

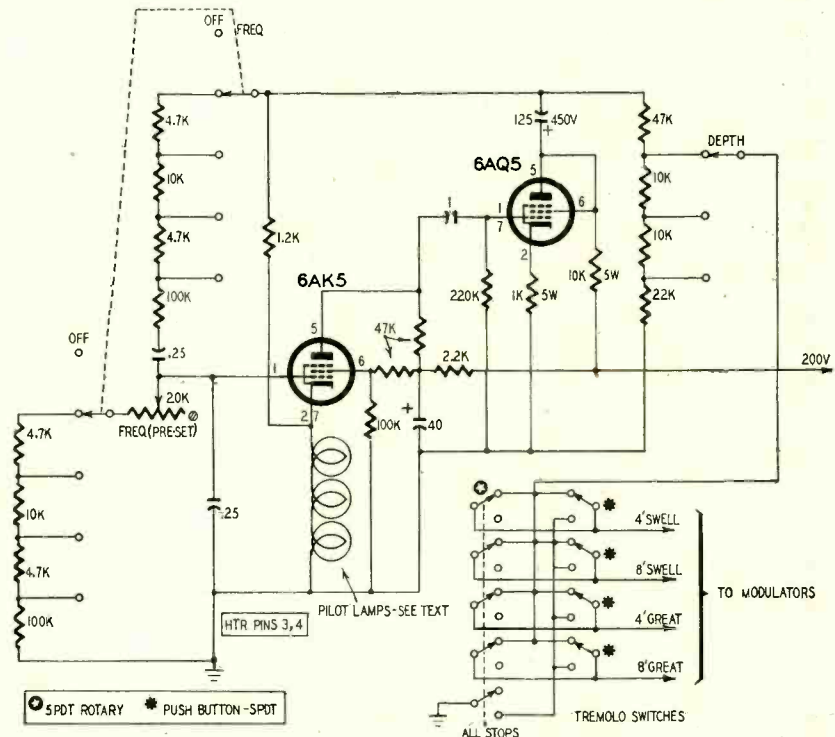
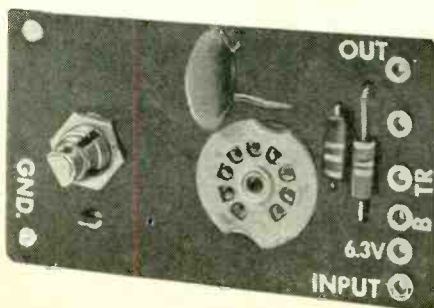

Fig. 1—Schematic shows circuit of a 4- to 8-cycle tremolo oscillator.

Front view of the modulator unit.



Modulator rear shows printed wiring.

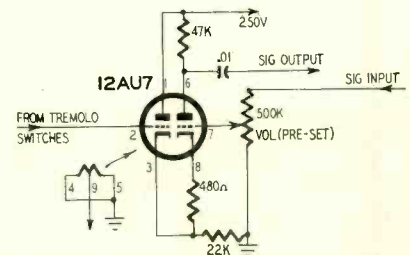
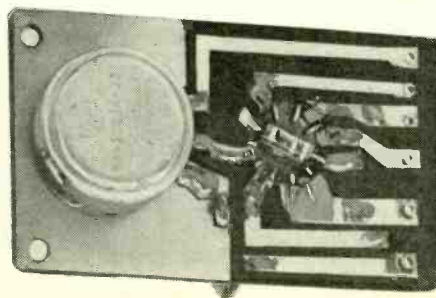

Fig. 2—Cathode-follower modulator.

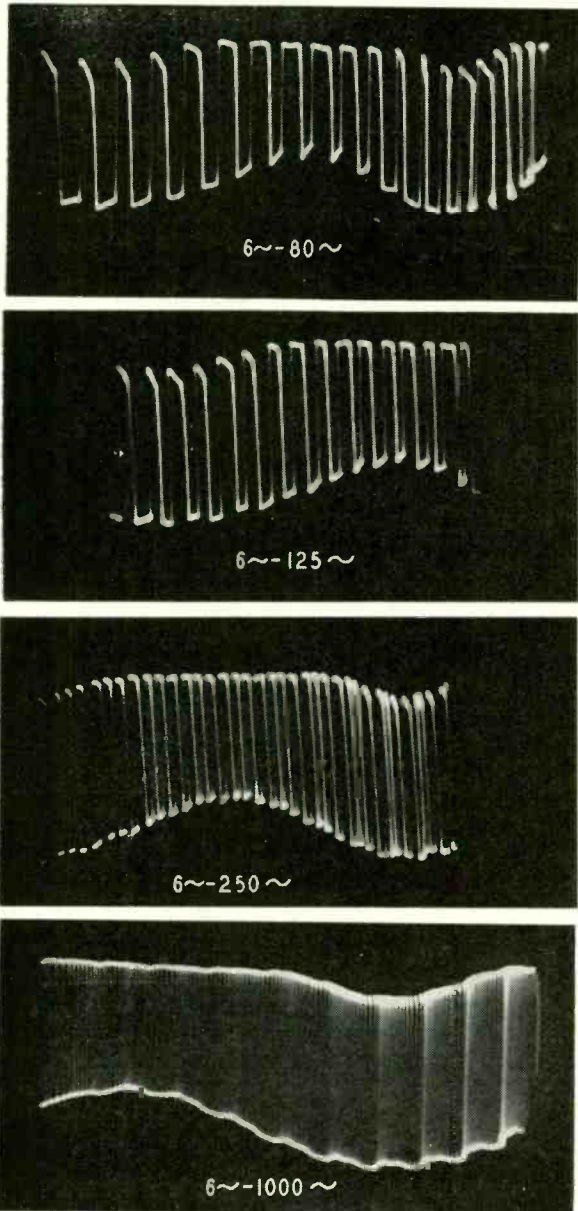

Fig. 3—Notes with 6-cycle tremolo

3-a—80 cycles

3-b—125 cycles

3-c—250 cycles

3-d—1,000 cycles

overblown and underblown, producing undesired transients.

No vibrato circuits are shown here because many electronic vibrato circuits have been published in RADIO-ELECTRONICS, particularly in the series of articles on electronic organs by Mr. Richard Dorf (July, 1950—September, 1952).

If the object is to build an electronic organ which produces music as does a pipe organ, there will be a number of pipes which virtually never get a tremolo. These include the 32- and 16-foot bourdon, 32- and 16-foot contra bass, 32-foot open diapason, the bombardes or the diaphones. Some of these would function very erratically or not at all if supplied with modulated air.

Thus a tremolo circuit should be sufficiently selective to provide tremolo only where it is desired. Such a circuit need not be complicated nor need it require a complicated bus arrangement to separate the various footage stops.

The first requirement will be a reliable low-frequency oscillator with ex-

cellent waveform. Even an apparently minor distortion may produce as part of the tremolo the very undesirable "plop-plop" heard even in some of the poorest bellow tremolos. The circuit chosen by me is shown in Fig. 1.

The tremolo circuit

The oscillator (Fig. 1) has provisions for four different frequencies from 4 to 8 cycles and an "off" position. There is a stepped volume or "depth" control, a frequency "preset" control and a series of switches to provide the tremolo on the desired stops. Tentatively the selection on my organ will be tre-

molo on the 4- and 8-foot swell stops and the 4- and 8-foot great stops. This may not be the best arrangement and it is certainly only one of many possible ones. Also shown is a master switch which will put tremolo into all stops except for the pedal klavier. These were purposely excluded for the reasons mentioned above. Future expansion of the tremolo section will be easy—it will only require addition of switches and modulators. All switches are s.p.d.t. except the master switch which is five-pole double-throw and so arranged that the lines to the modulators are grounded when not in use.

The oscillator should have a separate power supply or be well isolated from the power supplied to the rest of the organ by a low-reactance filter. This prevents undesirable coupling through the power supply.

The oscillator drives the modulators, one of which is shown in Fig. 2. It consists of a cathode follower coupled to a low-gain amplifier. The gain of the amplifier section with the values shown is about 3, with or without tremolo. The amplifier could be used as a booster or preamp, depending on its location in the circuit. Or the overall gain may be reduced with the volume "preset" control. The amplifier grid receives the signal from the tone buses, oscillators or formant filters and reproduces at the plate the signal with tremolo. Fig. 3-a shows an oscillogram of an 80-cycle note with 6-cycle tremolo. Figs. 3-b, c, d, respectively, show 125-, 250- and 1,000-cycle signals with 6-cycle tremolo. In all of these cases the tremolo has purposely been exaggerated for illustration. In actual use a 15-20% modulation will give a full tremolo and as little as 5-10% modulation is noticeable. The distortion of the low-frequency modulating voltage in these oscillograms is the result of nonlinearity in my oscilloscope sweep circuit and vertical amplifier at 6 cycles.

The circuit of the modulator is simple, compact and inexpensive. It is not frequency-sensitive over the range of

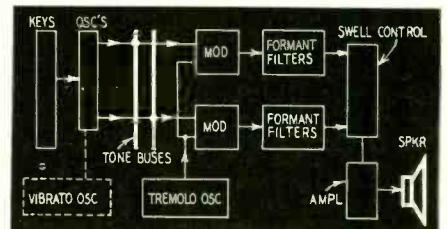

Fig. 4—Block diagram shows tremolo oscillator feeding two modulators.

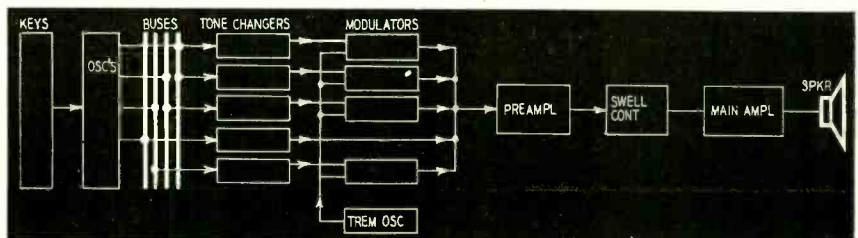

Fig. 5—Tremolo oscillator can feed several modulators without strain.



frequencies dealt with in organs and considerably beyond that point. No serious alterations of waveform occur and the tremolo oscillator output is not significantly loaded even by a number of them. Even a fair number of the modulators would cause no great strain on the organ builder's budget. As shown in the typical block diagrams (Figs. 4 and 5) they could be used in many different combinations with other organ circuit units.

By using a separate modulator, for example, for 4-foot reeds and flutes, 8-foot reeds and flutes and a common one for all strings, one could perform with a tremolo in a solo part and no tremolo in the chorus and base, and produce very realistic organ music.

Fig. 6 shows my tremolo control panel on one end of the console. Figs. 7 and 8, respectively, show the rear and bottom of the oscillator chassis. The peculiar shape of the chassis was caused by the available space in the console. The Westinghouse 55C 55-volt panel lamps (one G-E 3S6/5 115-volt 3-watt indicator lamp may be used instead) are mounted on a piece of heavy fishpaper. By cutting in the paper an I slot, about  $\frac{3}{4}$  inch long and  $\frac{1}{2}$  inch wide and bending the flaps, these slide-base lamps can be held in place and the connections soldered. The fishpaper can then be mounted as any mounting board.

**Parts for tremolo oscillator**

**Resistors:** 1—1,200, 1—2,200, 4—4,700, 4—10,000, 1—22,000, 3—47,000, 3—100,000, 1—220,000 ohms,  $\frac{1}{2}$  watt; 1—1,000, 1—10,000 ohms, 5 watts; 1—20,000-ohm potentiometer.

**Capacitors:** 2—0.25, 1—1  $\mu$ f, 200 volts; 1—40  $\mu$ f, 350 volts, electrolytic; 1—125  $\mu$ f, 450 volts, electrolytic.

**Switches:** 1—2-pole 5-position rotary; 1—1-pole 3-position rotary; 4—s.p.d.t.; 1—5-pole double-throw.

**Miscellaneous:** 1—6AK5 and socket; 1—6AQ5 and socket; 3—lamps, Westinghouse 55C or 1—G-E 3S6/5 115 volts, 3 watts; 1—chassis; 1—panel; 1—power supply socket; 1—output socket.

**Parts for tremolo modulator**

1—480, 1—22,000, 1—47,000 ohms,  $\frac{1}{2}$ -watt resistors; 1—500,000-ohm potentiometer; 1—01- $\mu$ f capacitor; 1—12AU7 and socket; 1—chassis for modulator.

As shown in Fig. 4, the use of tremolo does not in any way interfere with vibrato applied to the basic oscillators. Thus if vibrato is desired as well, it can easily be applied. Conversely, an existing organ with vibrato only can easily have this pipe-organlike tremolo added. For some really weird effects both could be used together.

The injection of tremolo must always occur ahead of the "swell" pedals. The control of volume must control the modulated signal since otherwise the depth of tremolo would vary with the volume. Since the swell pedal is most frequently used to control the final amplifiers or preamplifiers, this criterion is easily satisfied.

Although the modulator (see photos) was especially developed for use in electronic organs, it has already proven useful in other applications. One of these is the amplification of very low-frequency signals in a carrier type amplifier. END

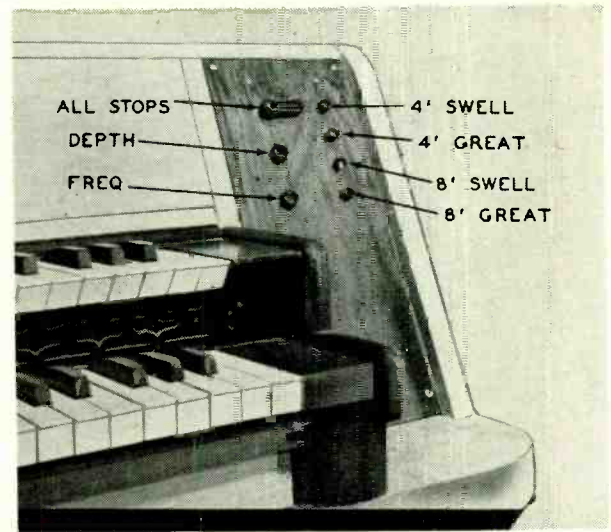

Fig. 6—The tremolo control panel.

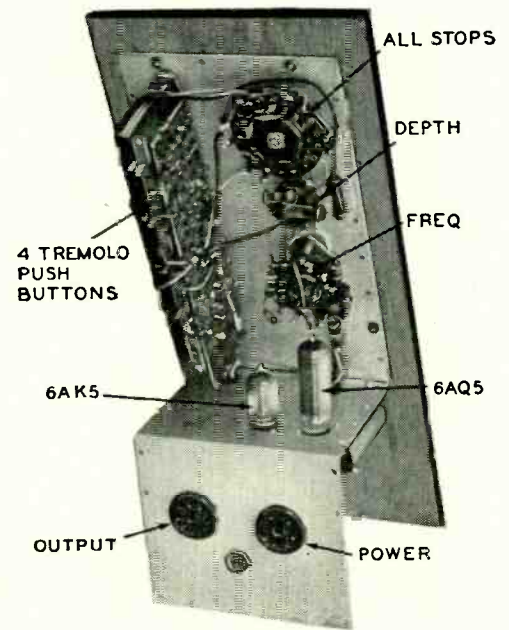

Fig. 7—Rear of the tremolo panel.

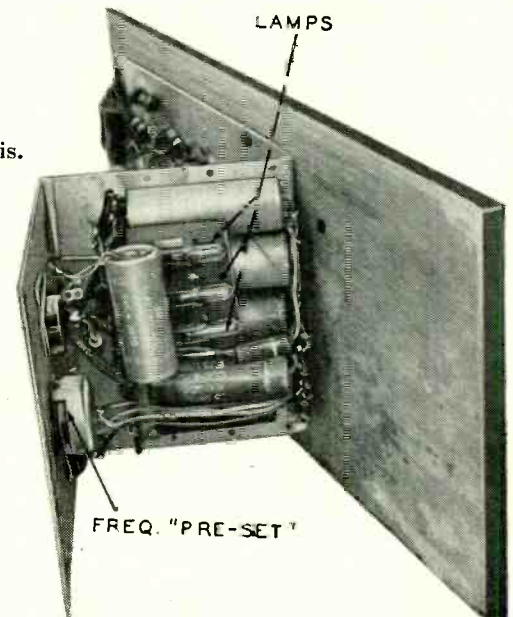

Fig. 8—Tremolo oscillator chassis.

# FOR GOLDEN EARS ONLY

*The Pilotrol PA-913 preamplifier-equalizer; Miracord XA 100 record changer and XM 100 turntable; new records review*

By MONITOR

THE excellent appearance of the Pilotrol PA-913 deluxe control unit, with its similarity to a broadcast console (see photo), will no doubt have a tremendous appeal to the audiophile who wants the most complete control and versatility, and the performance will not disenchant. The only thing I have found to criticize is the distortion at low levels which—though about average for control units—is considerably higher than that of the Pilot AA-904 amplifier with which it might be used. All other characteristics are excellent and some features are unique. The response in the “flat” position is flat from 20 to 20,000 cycles and the really nice thing is that it remains commendably flat at various settings of the volume controls.

The dashed lines in Fig. 1 give the response at successive -10-db volume levels as the control is turned down (loudness control in maximum position). The high-end response is flatter at the 25% point (where it is most likely to be in home use) than at higher levels. This is because no fewer than four volume controls are frequency-compensated.

The solid curves give the loudness contours, again in 10-db volume steps. There is no switch to disable the loudness control but none is needed. Instead there is a separate volume control. If the loudness control is turned to its maximum position and the volume controlled with the volume control only,

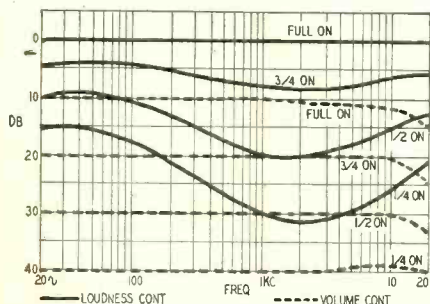

Fig. 1—Response of Pilotrol PA-913.

there will be no loudness compensation. However, various combinations of the volume and loudness controls can provide a very wide range of loudness contours at any volume level.

Fig. 2 gives the tone control curves. The bass control is particularly satisfying because it provides for a sliding turnover point so that, for example, a moderate amount of boost can be applied below 100 cycles with very little effect above it. The treble control, however, is of the hinge type. Still the compensated volume and level controls and the excellent loudness control make the treble control all but unnecessary. The only use I found for it was to compensate some types of prerecorded tapes, which unfortunately still vary widely in their recording curves. The hinged treble control is better for this purpose than the sliding-turnover type.

The preamp-equalizer is the most satisfactory commercial model I have ever used. It provides 25 combinations

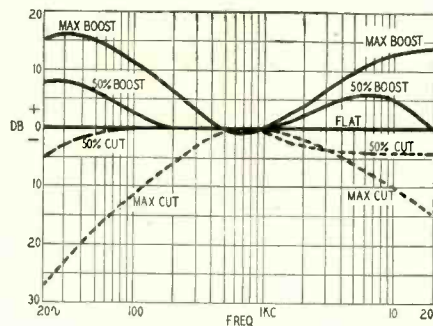

Fig. 2—Pilotrol tone control curves.

of bass turnover and treble slope. Furthermore, as Fig. 3 shows, the equalization is highly accurate. It is easy to hear the difference when either the turnover or treble slope is changed. A calibrated potentiometer provides the proper load for any pickup. A low-noise pentode is used in the input stage (Fig. 4) and d.c. is applied to the heaters of the low-level stages. This, with excellent hum filtering, produces a noise level so low that at normal

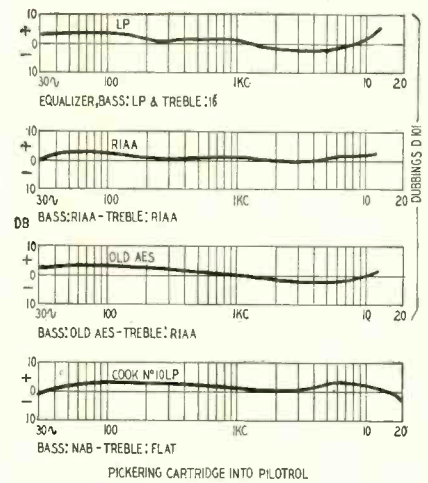

Fig. 3—Pilotrol equalization curves.

home listening levels it amounts to a complete absence of noise. Equalization is controlled by pushbuttons which change the constants of an interstage bypass network. The 0, 8, 16 and 20 treble buttons indicate the attenuation in db at 10 kc. The bass button marked 800 is for an 800-cycle turnover.

There is a microphone channel with a separate preamp and an independent compensated volume control so the mike can be mixed with any input channel. A tape output ahead of both the tone and loudness controls provides an unequalized input if desired. If the program needs some equalization for proper balance in recording, the tape output can be shifted to a jack in parallel with the jack feeding the amplifier where it can obtain an equalized signal. These two jacks can be used also for feeding two amplifiers or an amplifier and a line.

There are inputs for tape, radio and an auxiliary. The first two have compensated level controls on the back of the chassis so that the output level of all sources can be made about the same.

For my money the biggest feature of the Pilotrol is the use of pushbutton switches for the phono equalizers and



Miracord XM 110 single-play turntable.



The Miracord NA 100 record changer.



Pilotrol PA-913 pre-amplifier-equalizer.

the input selector. They are not only inherently quieter than rotary switches but because only one switching action is required to choose any input or equalization, there can be only one transient at worst. A rotary switch, passing through intermediate switch positions to reach a desired one, may produce six or seven transients. In this instance no thumps or chirps are audible and a sensitive meter shows the merest trace of transients. I predict that all deluxe control units will sooner or later use pushbuttons for this reason.

The Pilotrol has an excellent db meter

using an integral two-tube v.t.v.m. and one of the clever new edge-mounted segmental meters. The meter is calibrated in db with a range of +2 and -12 db. A rotary switch (the only one in the gadget) provides six multipliers and an off position. Although the multiplier uses 5% resistors I found it accurate and linear to within 1 db on all ranges. The frequency response is excellent, too, over the whole audio range. The unit is extremely sensitive—on the lowest scale 0 db represents an output of 65  $\mu$ v. The meter will be most useful to those who

have recorders without meters and those who do a lot of experimenting and want to make frequency runs and other measurements. But the Pilotrol would clearly make an excellent control panel for the centralized sound system in a school, restaurant, airport, hotel or elsewhere and could even be used as a small broadcast console especially in college carrier type systems and on remote pickups for small broadcast stations.

There is a most interesting and subtle design feature to reduce even-order harmonic distortion not evident from

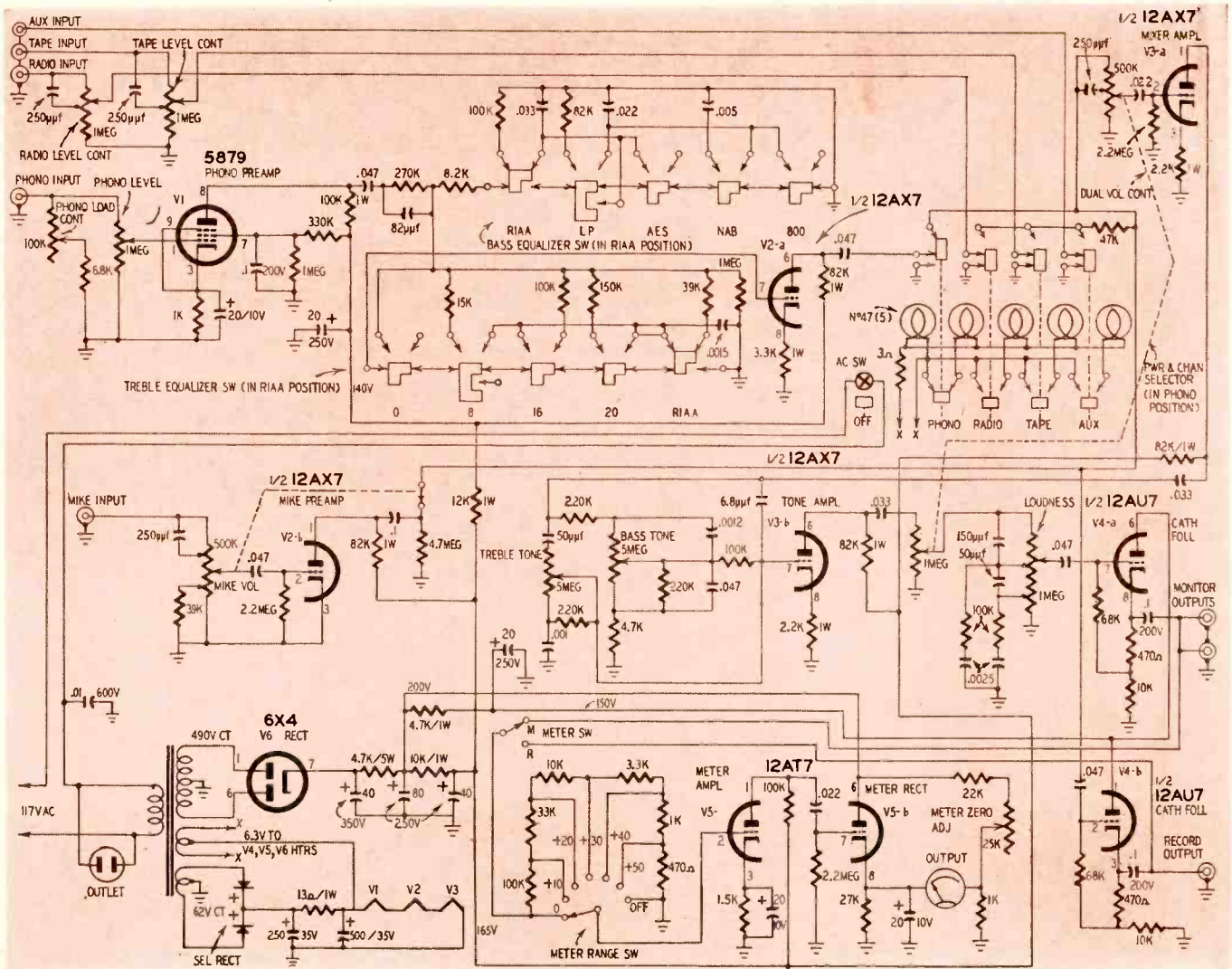

Fig. 4—Schematic diagram of the Pilotrol PA-913 hi-fi preamplifier-equalizer.

## AUDIO—HIGH FIDELITY

the diagram. The loss in the tone control network is just about equal to the gain in the half-section of the 12AX7 which precedes it. Therefore the current flowing through the second half-section which follows the tone control network is practically identical to that in the first section except that it is 180° out of phase. The first section produces a certain amount of distortion; the second section an equal amount. The result is that they cancel each other.

The Pilotrol comes in a wood cabinet with a sloping panel. However, the chassis can be removed and mounted in a rack or an equipment cabinet. For such mounting the panel can be adjusted by changing the position of the screws to provide the normal 90° panel. The workmanship looks excellent.

### Miracord XA 100 changer

This very clever product of Western German ingenuity will not take your records out of their jackets or wipe off the dust and static. But it will do just about anything else you could ask a changer to do and several things you never thought of.

The important qualities of a changer from the standpoint of listening are noise level, wow and tracking ability. The American distributor advertises "no rumble, no wow." This is an exaggeration; but it will take a lot of bass boost and a speaker system of very high efficiency below 40 cycles to show the rumble up. Thus, in this respect, the XA 100 (see photo) can stand up to the better professional type single-play turntables. As near as I can determine, the rumble is some figure between 45 and 50 db down from the level of a G-E cartridge and with the average speaker system, even a fairly large horn, it will not be a significant factor. The wow is also low, at least when the changer is new. And the fact that the speed switch has neutral positions between all speeds, in which the idler is disengaged from the turntable rim, ought to contribute to maintaining this fine condition—provided you make a habit of placing the switch in the neutral position. Merely turning off the turntable will not automatically disengage the idler.

Tracking will depend on the cartridge. Unfortunately cartridges differ in the overhang they provide when mounted in a given arm—the G-E produces excellent results. Needle pressure is easily varied with a knurled nut underneath the arm, but above the chassis, where it is always accessible. It permits a wide range of adjustment sufficient to obtain optimum pressure with all of the half-dozen cartridges I tried. I had no trouble obtaining good tracking over the full width of normal records. However, as is the case in other changers, you may be reluctant to play the last half-inch or so of such extended-play recordings as some released by Vox because the trip mechanism is often engaged before the arm reaches the end of the recorded grooves. Moreover, the pressure of the

trip lever against the arm has a tendency to cause groove-locking on such records. This occurs also in the manual-play position and caution is recommended when playing these "longer-playing" records.

From the standpoint of hum the changer is also top notch. This is partly the result of the motor, its extremely sensitive shock mounting and isolation, the shielding and the two-wire shielded cable provided in place of the normal one-wire cable.

As a changer it is extremely versatile, simple and practically foolproof. The mechanism is an extension of the principle used in the RCA 45-r.p.m. changer. All the work is done by the clever and precisely crafted spindle which holds the top records in a stack by an expanding spring while dropping the lowest one with retracting cams. Early models produced some troubles in dropping, and the new spindle will occasionally fail to drop a record if a portion of the paper label overlaps the center hole and jams up the mechanism (simply trim off the offending paper carefully with a sharp knife) or if a record is abnormally thick or thin.

Ten and 12-inch records of the same speed can be mixed without any adjustment. There is a feeler which "measures" the diameter of the record as it drops and adjusts the setdown mechanism to conform. If inserts are used, 45-r.p.m. records can be played on the same spindle but cannot be mixed, or a big-hole spindle is available as an extra. Placing the speed switch in the 45-r.p.m. position automatically adjusts the arm setdown. The changer is particularly immune from bad effects if the arm is seized or moved during the change or playing cycle. On some changers this may result in a complete misadjustment requiring an expert to correct. Here, as far as I have been able to determine, the worst that can happen is that the changer may skip a change or set down in the wrong position. Incidentally, a very nice feature is that the arm can be adjusted so that if it misses the edge of a 10- or 12-inch record, it will merely hang in free space instead of banging on some part of the changer. When the last record is played, the arm comes back to rest and power is automatically shut off.

But the above by no means exhausts the possibilities. You can have two types of repeats: delayed—the record won't repeat until it has been played to the end; immediate—the arm lifts almost immediately following the pressing of both the starter and repeat buttons and returns to the beginning of the record.

Furthermore, you can adjust the pause between records in five steps ranging from 5 seconds to nearly 2½ minutes in the case of 78's, and from 12 seconds to 5½ minutes for 33's. This should be very useful for music, music appreciation, dancing and skating teachers, and no doubt also for dancing parties in the home to permit everyone

to catch a breath or find a better partner between numbers. Finally, one of the four pushbuttons inserts a low-resistance load across the pickup to roll off highs and thus reduce scratch on noisy records. As it comes, the resistor is cut for the G-E but it is easily replaced. Moreover the switch itself could be converted to such purpose as changing the load when different cartridges are plugged in. Because it locks in, it will remain engaged through any variety of changing cycles or manipulation of the other buttons.

The XA 100 can also be used as a single-record turntable and makes a particularly good one because there is no superstructure to interfere with record placement. The spindle is merely changed to a shorter one and no other adjustment or button pressing is needed. Incidentally, clips hold the various spindles in place when not in use. There is also a big-hole insert for use with 45 r.p.m.'s. Operation can be manual or semiautomatic. That is, having put the record on the turntable, one can merely press the start button. The arm will lift, the turntable will start revolving and the arm will set down in the proper place, to be returned automatically at the end of the record. Or, you can put the arm down by hand at any point on the record except the final inch or so where the trip mechanism is difficult to circumvent even if one tries to sneak up on it. If you want to repeat a record over and over while practicing a dance, you merely turn the short spindle upside down.

Despite all this rather awe-inspiring versatility the mechanism is surprisingly uncomplicated, sturdy-looking and positive enough in action to appear to guarantee considerable freedom from trouble.

### XM 110 single-play turntable

For those who do not care for a changer, Miracord offers a single-play turntable (see photo) with many of the fine qualities of the changer. The rumble, noise level and wow are also extremely low. The same speed switching method is used and neutral positions between all playing speeds disengage the idler. Operation is manual. After putting the record on the table you simply pick up the arm, move it slightly to the right—engaging the on switch—and set it down on the record. At the end of the record the motor is turned off. Very simple to use, it would be especially useful when children use the hi-fi outfit. The plug-in heads for the cartridges are the same as those used in the changer and will accommodate just about any cartridge with ½-inch mounting centers. Needle pressure is adjustable as in the changer.

Both changer and turntable use a rubber mat with concentric raised ridges which should provide a minimum of transfer of dust and dirt from mat to record. A sensible feature is that the mat is easily removed and washed. Both

the changer and turntable are very easily mounted and in a very compact space. The distributor also offers inexpensive but handsome fabric-covered bases already cut; it takes scarcely 10 minutes to put either outfit together. The German manufacturer deserves commendation for the very clever method of packing these instruments and for providing a packing chart, a useful feature for those who have to move often.

**New records review**

*Note: Records below are 12-inch LP and play back with the RIAA curve unless otherwise indicated.*

**The Sounds and Music of the RCA Electronic Music Synthesizer**

**RCA-Victor LM-1922 experimental**  
This may become a historical recording, the first expression of what could well be a radical revolution in music and sound. But whether it is or not I think everyone interested in either music or sound will want to hear it and it would be a discussion-provoking item in any hi-fi concert. RCA takes both sides of the jacket and one of the record—in the voice of overdone ham without which the record would be much more impressive—to tell what it is all about. I will not attempt to summarize except to say that this is the first recorded example of completely synthetic music, produced by completely electronic means, without any performers and direct, as it were, from the pen of (in this case) an arranger. There is nothing especially notable on it from a hi-fi point of view except the clear indication that the best of it would have been impossible without the developments in audio produced by the high-fidelity engineers; the music itself is noteworthy mostly for its mechanical quality. Many an audiophile may find it very helpful for its simple analysis of the elements and components of music and how they are combined to produce a given tone or effect.

**Sound of Frequency**

**A Test Record with notes by Peter Bartok Folkways FPX-100**

A most useful addition to available technical test records with some absolutely unique material including, for the first time, 100- and 1,000-cycle square waves and a novel and simple intermodulation test.

Side 1 is recorded at 78 r.p.m. but can be played with either 1- or 3-mil needles. It is recorded with a 500-cycle crossover and flat treble presenting frequencies from 15.6 to 22,500 cycles. Optical examination proves the sweep is excellently flat and even the 22.5-kc tone is captured solidly and flatly. Unfortunately, the response of LP cartridges when played back at 78 r.p.m. is not accurately representative of their response at 33 r.p.m. and the run is not as useful as it might be. However, the increased speed will exaggerate any peaks and irregularities and will also provide fairly valid side-by-side comparisons of different cartridges or keep track of the performance of one cartridge over a period of time. Side 1 also provides an excellent test for translation loss and tracking distortion by offering identical frequencies on the outermost and innermost bands. A translation loss of much over 6 db will indicate either a poor needle or poor tracking or both. Finally, there are three bands giving the three standard pitches for A—444, 435 and 440. These can be used to check a turntable's speed against a pitch pipe, tuning fork or accurately tuned piano or the audio tone of WWV and also to adjust speed for proper pitch if the turntable has a speed adjustment.

Side B is at 33 r.p.m. but can be played also with both needles. The first two bands offer the 100- and 1,000-cycle square waves. Much to my surprise the better pickups do an extremely good job of reproducing them although there is always a ripple on the top which I presume is at least partially recorded. Aside from a measure of transient response and stability these give a quick check of equalization.

There are two bands for checking IM: a 16-kc wave and an 8-kc wave both amplitude-modulated

by 60 cycles. If the system is completely linear and neither side of the envelope is rectified, the ear will hear only the carrier tone for the same reason that the ear hears nothing when an r.f. wave modulated with a sound wave is fed into an audio amplifier. (The modulation on the two sides is out of phase and as long as both sides are passed without distortion, cancellation occurs.) But if the symmetry is disturbed by rectification or distortion the modulation will become audible to some extent. I have some reservations about the sensitivity of the method. My quick and perhaps inadequate checks appear to indicate that the distortion has to exceed 5% before it is evident to the sharp ear and 10% before it is at all obvious. But, though this may limit the usefulness of the bands for absolute measurement, there is no gainsaying that it is a simple method and provides the audiophile without instruments a means of keeping check on his equipment and spotting trouble at a fairly early stage.

There is another frequency sweep at the 33.3-r.p.m. speed but this time from 31.3 to 16,000 cycles. Unfortunately this sweep is equalized to the "Bartok" curve which uses a 630-cycle bass turnover, requires a 23-db boost at 30 cycles, a 1,590-cycle treble turnover and a 16-db slope at 10 kc. The old NAB equalizer or NAB bass and LP treble will do a fair but not exact job of reproducing it. Finally, there are three bands of music intended to show that the Bartok curve is superior to both the ancient 78-r.p.m. and RIAA curves. This special pleading takes away from the usefulness but the first band will give a good check of tonal balance of 78-r.p.m. equalizers and the RIAA of RIAA equalizers.

**La Danza**

**Carmen Dragon and Hollywood Bowl Orchestra Capitol P-8314**

A top-notch demonstration and showoff recording with emphasis on beautifully sharp and clean high-highs, not especially notable bass but a nice presence and liveness despite the fact that it was recorded in an outdoor shell. The music which will please all but the most blasé includes the *Mexican Hat Dance*, *Tico-Tico*, *Siboney*, *Cielito Lindo* and other Spanish or Spanish-American dances in lush orchestrations. Played moderately loud on a good system it will produce a highly satisfying and impressive example of the worth of high fidelity.

**Folk Songs of the New World**

**The Roger Wagner Choral Capitol P-8324**

I recommend this as possibly the best showoff or demonstration of choral capabilities of high-fidelity records and systems. The presence of the voices is startling although a little artificial since it represents what the conductor rather than an audience would hear. Clarity and definition are absolutely topnotch, and the selections are a baker's dozen of favorite American folk songs—*Cindy*, *Blue Tail Fly*, *Streets of Laredo*, *Skip to My Lou*, etc. Folksong purists may decry the "modern" choralization and I raise a small criticism to the out-of-dynamic scale of the occasional solo voices. But I'm sure any system which does this disc justice will impress the hearers mightily and favorably.

**PROKOFIEFF: Sonata in D Major, Op. 94**

**HANDEL: Sonata No. 4 in D Major VITALI: Chaconne**

**Nathan Millstein, violin with piano accompaniment Capitol P-8315**

The music is not at all likely to appeal to anyone not a fiddler or connoisseur of violin music, but the recording possesses an incidental test value for those who do like the music. Capitol in these Millstein discs has been doing a fine job reproducing the fiddle in all its rosin realism when heard close up. Improper equalization or a peak in the cartridge will distort the harmonic structure, however, producing an unpleasant shrillness with a boost or peak and an unnatural mellowness with a slope or hole. I find it very useful for quick checks on pickups, equalizers, poor needle condition, etc.

**BIZET: L'Arlésienne Suite**

**FAURE: Pelléas et Mélisande**

**Orchestra of Radio Paris conducted by Le Conte Capitol P-8311**

Very felicitous recordings of these popular

works with a nice liveness, excellent definition and very clean except for a touch of stridency in the strings and distortion in the finale of the *Pelléas*. There are excellent drums in the *Farandole of L'Arlésienne* whose complication makes an excellent test for definition and tracking distortion. The *Pelléas* has an excellent string bass and its *Scilienne* one of the loveliest melodies in the library of classics.

**STARLIGHT ENCORES**

**Hollywood Bowl Orchestra John Barnett, conductor**

**Capitol P-8296**

This is almost as good demonstration material as Capitol's *Studies in High Fidelity*. The overall quality is not as good as on those specially cut discs but the music here covers a wider range of interest, is pleasanter to listen to and should be more popular than the classical side of the *Studies*. The selections are: Ponchielli's *Dance of the Hours*, Liszt's *Second Hungarian Rhapsody*, Tchaikovsky's *Andante Cantabile and Marche Slave* (quite spectacular), Saint-Saen's *Danse Macabre* and Offenbach's *Orpheus in the Underworld*.

**BACH: Partita No. 2 in D Minor**

**Sonata No. 1 in G Minor Nathan Milstein, unaccompanied violin Capitol P-8298**

Capitol gives us another startlingly realistic recording of the violin in the expressive hands of Milstein. Though the music is principally for Bach fans, there are portions of hi-fi interest. One of the things the fiddler hears but his audience almost never does is the peculiar low-frequency transient produced as his fingers release the strings. Here, especially in the *gigue of the Partita*, these transients are beautifully reproduced. The presence is phenomenal; Milstein appears to be right at your side.

**RIVERBOAT SHUFFLE**

**Preacher Rollo and His Five Saints MGM E-220 (10-inch LP)**

Very good revival Dixieland and sounds good on hi-fi systems. Just about worth the price alone is *Chimes Blues*, a seldom heard slow blues in which a piano, tuned for a chime tone, backed by a bass bowed in its lowest register to imitate the beat notes produced when several bells are rung, produces a beautiful and novel effect. The other selections are *Riverboat Shuffle*, *Muskrat Ramble*, *Livery Stable*, *Tap Me*, *Jazz Me* and *Royal Garden Blues*.

**LATIN AMERICAN DIXIELAND**

**Panama Francis and his Dixie Don Juans**

**MGM X-1128 (extended play 45 r.p.m.)**

A novelty for aficionados of Dixieland, consisting of the rhythm of some kind of Caribbean drums underneath the double bass. The bass is excellent—extremely fine for testing speaker response if you play it at 33 instead of 45 r.p.m., (which incidentally results in fairly acceptable music). There are four selections: *Beale Street Blues*, *Panama*, *Dead End Blues* and *Fidgety Feet*.

**BELL RECORDS**

You may have noted in your corner drugstore or newsstand a bank of 7-inch recordings at the low price of 39c each, labeled *Bell* and distributed by Pocket Books, Inc. In case you've wondered if they're worth the money, I can assure you that they are. There is little of hi-fi interest in them except that the voices often have a pleasantly closeup naturalness. For the most part they are vocal renderings of hit-parade tunes. Technically they are of considerable interest because they are available not only in 45 r.p.m. with the big hole, but also in 78-r.p.m. microgroove with the small hole, a type of recording technique hitherto used almost exclusively by the superb Audiophile. If your changer or player can play these 78-r.p.m. 7-inch discs with the small hole and microgrooves, I recommend them over the 45 r.p.m. The quality seems to be slightly better at both extremes of the range, especially in the last portion of the record. END

Names and addresses of manufacturers of any items mentioned in this column may be obtained by writing Monitor, RADIO-ELECTRONICS, 25 West Broadway, New York 7, N.Y.

# what's

# new

# ?

## Electrostatic Speaker

Electrostatic radiator, made by Janszen Labs, is not only a tweeter but operates efficiently at frequencies down to 500 cycles. Speaker consists of four radiator units, placed to disperse sound. Photo shows a complete speaker with four radiating sections, which look like the unit in the insert.

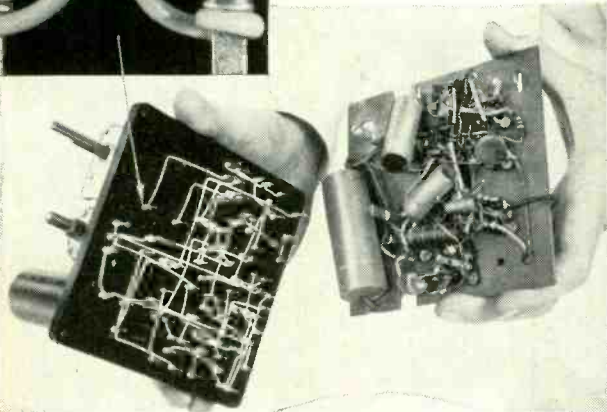
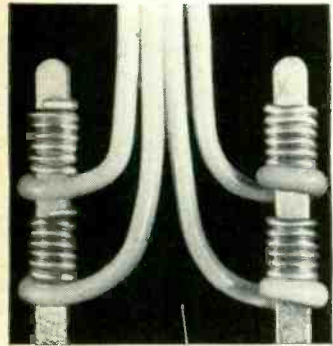
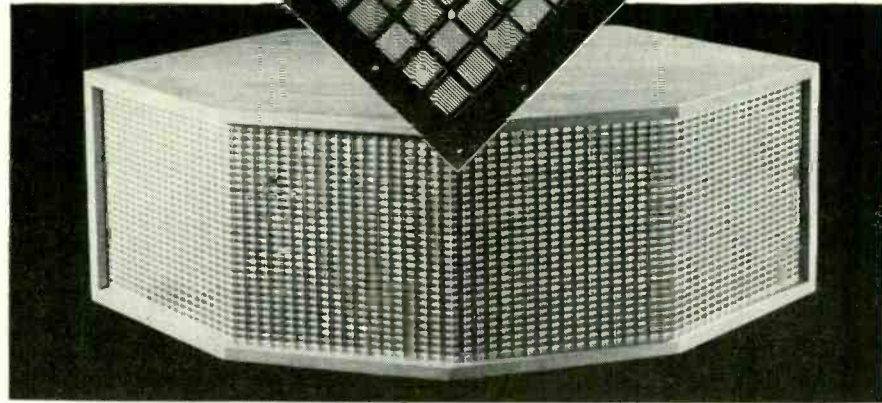
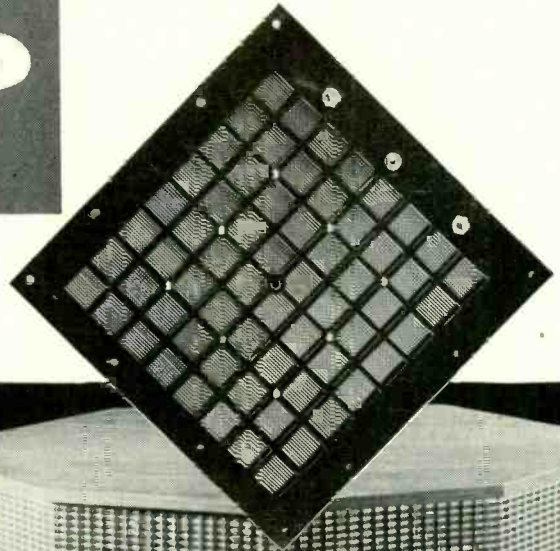

## Circuit Connections

Corrosion-resistant, solderless connections which are expected to provide trouble-free joints for the whole life of the equipment on which they are used are made by a new machine developed by Bell Laboratories. The connections are made by wrapping six turns of wire around rectangular terminals. The wires bite into the terminals, with a pressure of about 15,000 pounds per inch at each contacting area. Photo above shows a board wired by the new method compared with a conventional wiring job. Inset shows how the wired connections look, and the arrow points to one of them. The Bell machine is programmed with a tape and can wire up a whole circuit board of the type shown above, stripping insulation from the wire ends, wrapping them around the correct terminal, then proceeding to the next as instructed by the tape. The method has also been used with hand-controlled tools.

## Electronic Organ

The organ at the right was conceived, designed and constructed by H. Meijer, Jr., of Amsterdam, Holland, who has followed the articles on electronic music in this magazine with great interest, and to which he gives credit for inspiration and a great deal of help in the details of design. Mr. Meijer informs that in his latest modification the two speakers now visible have been removed.

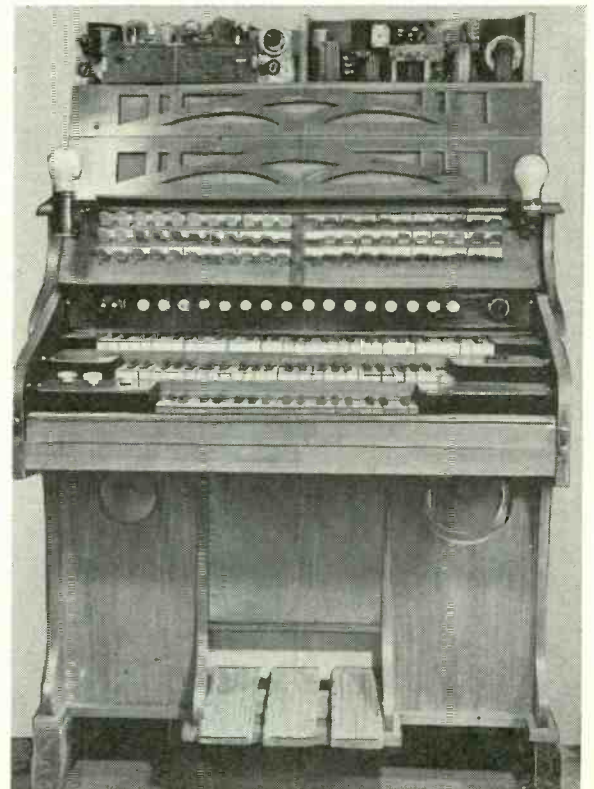

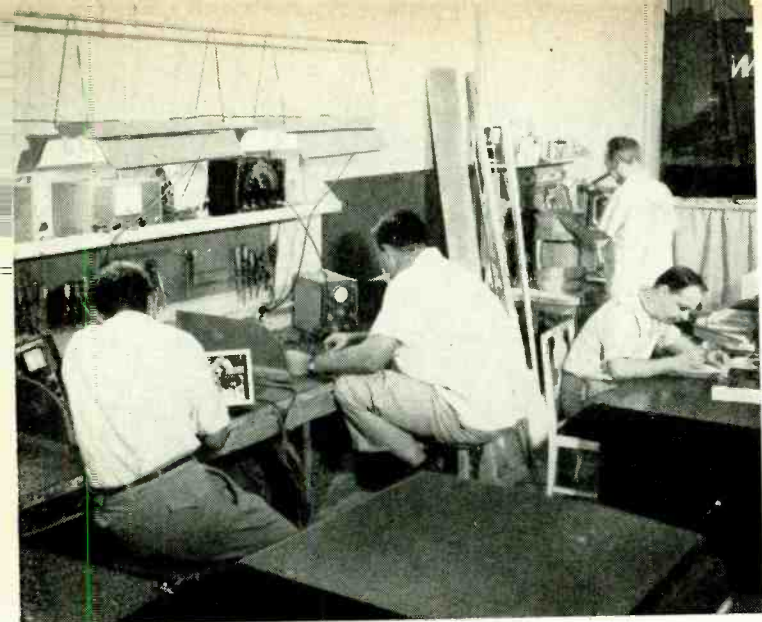

### Hi-Fi Do It Yourself

Enterprising owner of the Audio Repair Service, Miami, Fla., found a way to cash in on the "great deal of free information" he was called on to provide customers building their own audio equipment. Facilities and tools are provided and advice given the audio constructor at a fee which the builder considers nominal and which turns the former liability into a profit. "Any type of audio service work may be undertaken in our shop, even cabinetry," says Vic Rondel, the owner. "Work is supervised to a successful conclusion and the cost remains nominal. Local hi-fi dealers look on the idea as a means of promoting sales, and it even proves a stimulus to our own service work."

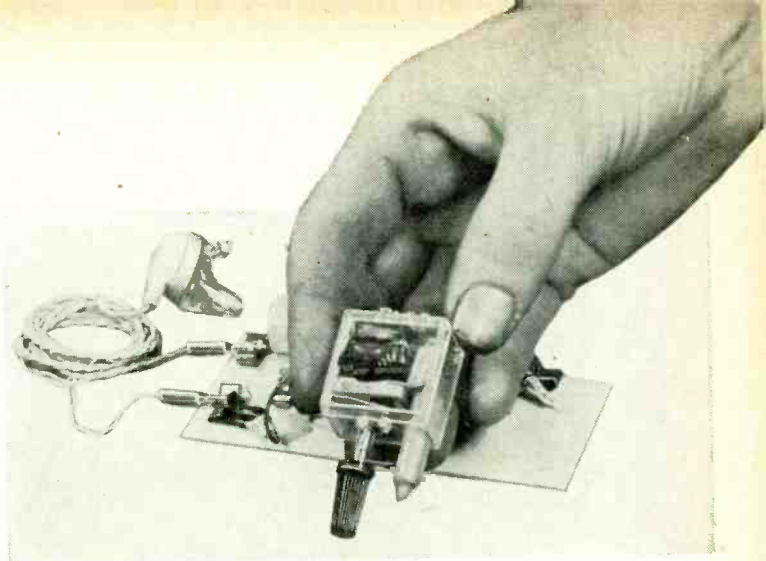

### Miniature Radio—at Last

A buttonhole-size FM radio is announced by Glen Ecker, California inventor. Hardly a cubic inch in dimensions, this little FM receiver actually does pull in stations. Performance is not to be compared with that of larger sets, but is surprising for one subminiature tube. With a pair of headphones in place of the single earpiece, the reception can be said to be on the entertainment level. The set uses a superregenerative circuit, and detection is by the slope method, in which the set is tuned slightly off the signal to be received. Tuning device is a compression-type mica trimmer capacitor. The power supply is a penlight A cell and a 30-volt battery, which are mounted on the plastic tile shown in the photograph above.

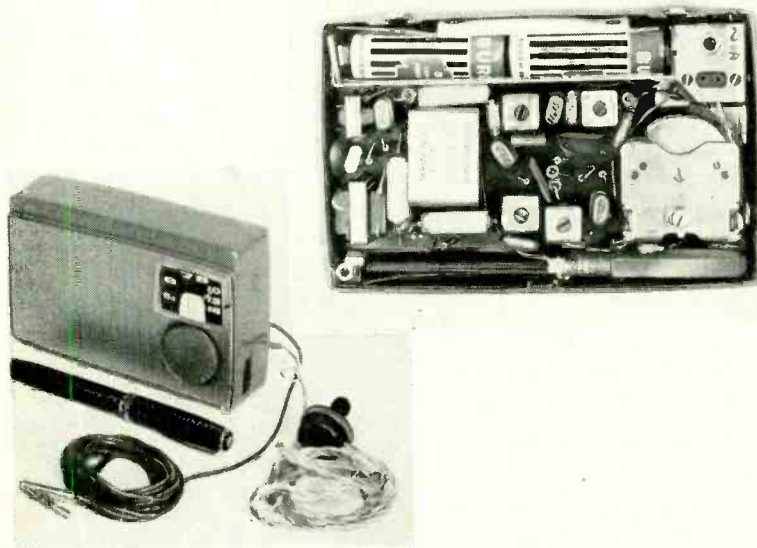

### Japanese Transistor Portable

New Nipponese five-transistor radio compares very favorable with American receivers of similar size. It has two i.f. stages, two audio stages, converter and uses two diodes for detector and a.g.c. Maximum output is 100 milliwatts, and output at 10% distortion 50 milliwatts. The power supply is four penlight cells (6 volts). Either a 2 1/2-inch dynamic speaker or an earpiece can be used. Transistors are made under Western Electric license, and the company, Tokyo Tsushin Kogyo, is putting out a class-B seven-transistor model at an early date. The seven-transistor job is rated at 100 milliwatts maximum output and 50 milliwatts at 10%, using a class-B output circuit.

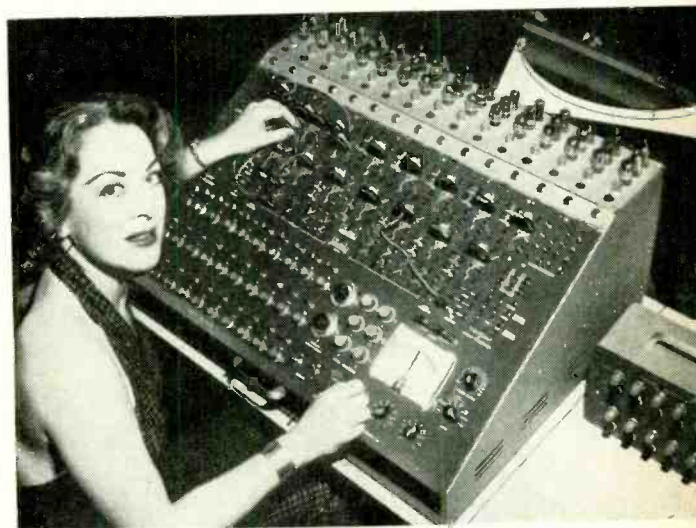

### Biggest Heathkit

This job is an analog computer in kit form for use of schools, laboratories and research organizations. The kit will sell for around \$750, contains 6,000 parts, 65 tubes, 5 relays and 35 diodes. Extending the principle of the sliderule to the log-logth power, it is expected to be a valuable means of training future engineers and to permit universities and small industries to investigate projects previously impossible because of the length of time required to make the computations.

## MAKING

## PHOTOETCHED

CIRCUITS  
IN YOUR  
WORKSHOP

*Part I: Process permits  
simplified construction;  
making drawing  
and negative*

By RICHARD H. DORF\*

THE printed circuit shown in Fig. 1 was made in my own laboratory. Any electronics worker—professional or hobbyist—can make his own printed circuits in the same way without any special industrial equipment and without any more space requirement than needed for ordinary chassis work. The circuit of Fig. 1 is a tone generator panel for Schober Electronic Organ kits. Instead of spending perhaps several hundred dollars on professionally made samples to determine the correct final design, the panel was made in my laboratory at a total investment of perhaps \$25 in equipment and materials and an individual cost for each experimental panel of much less than \$1.

Almost any electronic device produced in any kind of quantity can be made more cheaply with etched circuits because of the vastly shorter time required for assembly. But aside from low cost in production, printed circuits have advantages appealing to any user, even the amateur and hobbyist who may make only one or two of a particular gadget. No other electronic construction lends itself to easier troubleshooting and servicing. All wiring and component leads are immediately accessible for test and measurement. To replace a component or lift one end from the circuit to measure its resistance or capacitance, it is necessary only to apply a soldering iron briefly to the proper solder blob and lift the component. The capacitor or resistor is not damaged by this operation and can easily be replaced by simply pushing each lead through its hole and again applying the soldering iron.

Very often printed-circuit devices are more compact than those with ordinary wiring. Tie points and terminal

boards are not required. Wiring is neat and orderly so that such factors as interwiring capacitance are fixed and predictable. The panel can be marked with the schematic symbols for the components so that each can be located quickly—note the R and C numbers in Fig. 1—without a single extra operation.

The industrial procedure is to make a drawing of the required circuit in ink (though several firms now make available the necessary lines and dots which can simply be stuck down on drawing paper without using any ink). The drawing is then photographed to make a negative. The negative is projected onto a foil-clad panel coated with a light-sensitive acid resist. Those areas struck by light harden and remain while the rest washes off in the developing. The panel is then immersed in acid which eats away the foil not protected by the hardened resist.

This process is by far the most practical for any printed-circuit work. It can be carried out for small quantities—even for single panels—in any workshop or laboratory at very low cost and without any special training or equipment, even to the making of the negative from the drawing.

#### Making the drawing

The first procedure is to make the drawing. It should be in ink on a good grade of drawing material such as Bristol board. Use India ink. Beauty is a matter for individual esthetics, the important items being schematic correctness and such small points as making sure the lines are wide enough—1/16 inch is enough for almost anything—and have enough separation, 1/16 inch also being a good minimum figure. A line this wide will carry enough current for any normal chassis use, including filaments.

Provide a ground bus if one is required. A good trick is to carry it to at least one point where the screw or bracket fastening the panel to the metal chassis, if any, will make ground automatically. At each point where a component or other lead is to be connected to the panel make a pair of concentric circles, the inner about 1/32 inch in diameter and the outer around 3/16. Then fill the space between the two with ink, obtaining the connection dots seen in Fig. 1. Fig. 2 is the original drawing from which the tone generator panel was made. If any holes for mounting or such purposes are to be made in the panel, draw two concentric circles at the spot, the inner always about 1/32 inch and the outer the size of the final hole. The small circle serves as a center for drilling; the foil circle will be raised and will guide the drill automatically, just as a center-punch mark does in a metal chassis. It is very often useful to mark the panel extensively. Letter component symbols, B plus and ground identification, input and output points, etc., on the drawing, either by hand or with lettering guides. These will be reproduced on the final piece in the form of foil just like the circuit lines. They will conduct, so make sure they will not interfere with circuit operation.

Making the drawing requires thought in layout so that the circuit will be compact, yet complete. Usually it is necessary to make several pencil drawings as trials before obtaining a satisfactory scheme. When the final pencil drawing looks good, fasten it on top of the Bristol with drafting tape. Then, using the finest-pointed tool available—usually the steel point on the nonbusiness-end leg of a drawing compass—prick holes through the penciled paper into the Bristol. When you re-

\* Electronics consultant, New York.



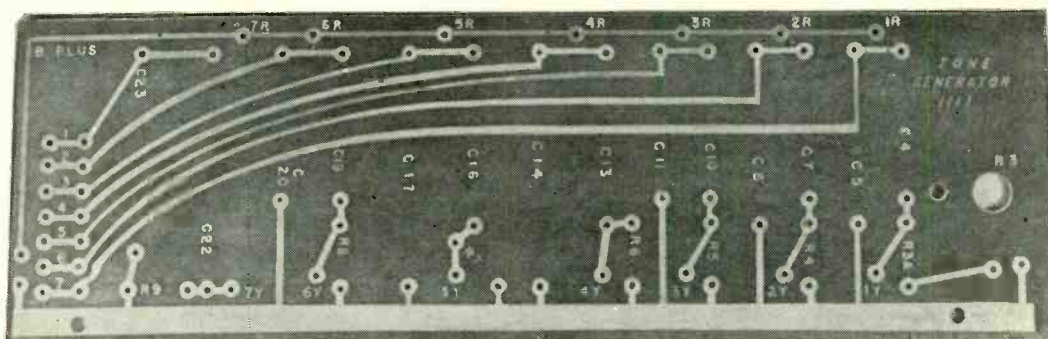

Above—Fig. 1—Author's etched circuit panel. Coding of parts simplifies assembly. Below—Fig. 2—The original panel drawing—India-inked on Bristol board.

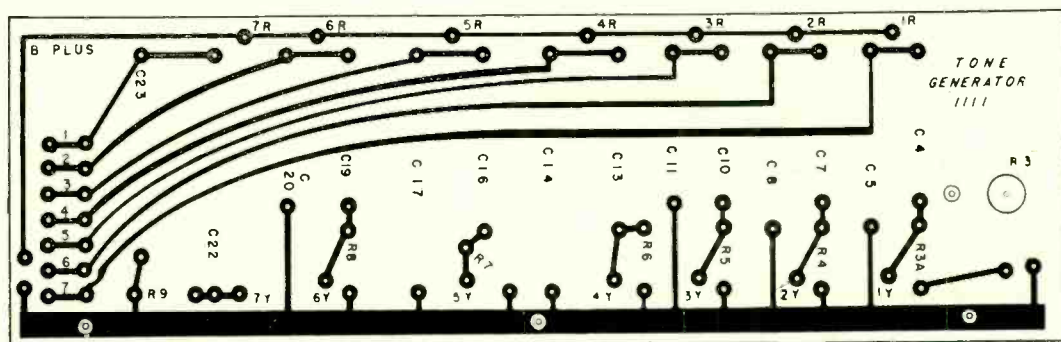

move the paper, the Bristol will have all connection points marked by the pricks and you will then simply draw the dots and connecting lines in the proper places by referring to the pencil drawing. Do not make the pricks too deep in the Bristol board as they may then appear dark; you want light dots in the middle of the black connection dots for drill guiding in the finished piece.

Before going further, clean the drawing where necessary with white. Perhaps the best white to use for this purpose is a new product called Snopake, a 1-oz brush-cap bottle of which, plus some thinner, can be obtained for \$1 from Fototype Corp., Chicago 13, Ill. Snopake may be brushed over any unwanted ink marks and allowed to dry for a few seconds. It is quite opaque and when used to correct errors it can be inked over without any difficulty. Rich Art moist water color, No. 14 poster white, or a similar product, is also suitable for opaquing ink marks but is harder to use and cannot be inked over. It may also crack and flake, which Snopake will not do.

### Making the negative

A photographic negative must now be made from the drawing and it will be used to expose as many panels as may be desired. In commercial quantity work it is usually desirable that the drawing be three or four times the size of the finished panel; the negative is made in reduced size by a copy camera so that small inaccuracies disappear. However, if any care has been taken in making the drawing—and especially if mere appearance is not of the highest importance—the drawing may be

made the same size as the panel. If it is, no camera need be used.

Whatever the size of the drawing, one easy, though not necessarily cheap, way to make a negative is to hand the drawing to a local photographer or photocopier and have him photograph it with a copy camera. If you do this, be sure to tell him to make the negative on film, not on photostat paper, and insist several times that he measure the focused image on his ground glass very carefully to see that the negative size will be right. You may indicate outlines on the drawing either by an inked border or by a right-angle mark at each corner.

If you are interested in doing the whole process yourself or if you may have occasion to do more than one kind of panel and want to save money in the long run, you can make the negative yourself—provided the drawing is the same size as the printed panel is to be. To do this you will need two kinds of Kodak film plus ordinary photographic developer and fixer, and a simple exposing system.

The first step is to transform your drawing, on opaque board, to black lines on a translucent medium. For this Kodak Autopositive film is easy to use. It, together with the other Kodak products mentioned in this article, may be obtained at any Kodak outlet which sells industrial products. If you are in a small town without such an outlet write to Eastman Kodak, Rochester, N. Y., for information about where to buy.

The Autopositive film comes in cut sizes. Choose a size large enough to cover any future printed-circuit panels you may want to make. To expose it

you can use any ordinary vacuum frame or print exposure device accessible to you. The light must be yellow. With ordinary light sources you get the yellow by placing Kodak yellow sheeting between the light source and film.

You can, if you like, make a simple light box (Fig. 3). This is a wooden box with several gold-colored fluorescent lamps in the bottom and a sheet of glass on top. There is a flat board hinged cover with a thick sheet of foam rubber cemented to it. When the cover is down and locked, the foam rubber presses the materials together so that good contact prints are obtained. Using the gold fluorescents makes yellow sheeting unnecessary. This same box, incidentally, can be used for making Autopositive paper prints from drawings, letters and the like.

A third and even simpler setup is just a sheet of heavy glass and a table with a lamp suspended above it. This is just as good, provided the drawing is not so large that the light at the edges will be much less than in the center. Raising the light higher will offset this condition.

To make the print, arrange the materials as shown in Fig. 4. The emulsion side of the film is the gray side. This process gives a reflex positive, with light values the same as in the original drawing. The light passes through the film without affecting the emulsion. It is then reflected from the white parts of the drawing onto the emulsion, but not reflected from the inked parts. With Autopositive film and paper, unlike ordinary photographic media, the emulsion turns white or translucent where lightstruck and goes

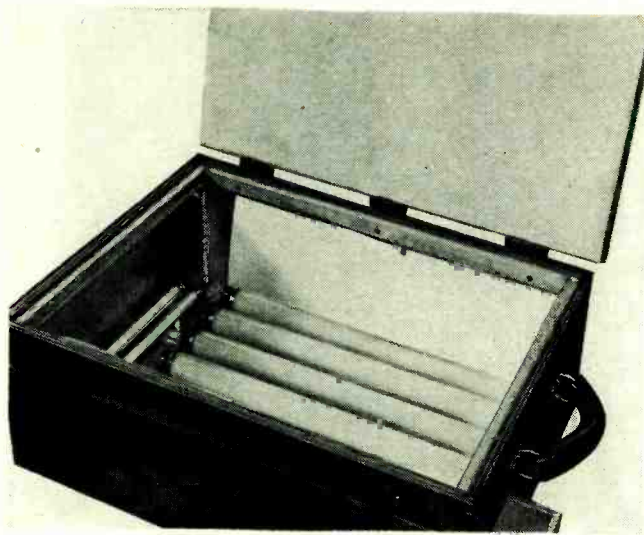

Fig. 3—A simple exposure device.

black where there has been no light. Be sure the materials make good, flat contact at all points so that there will be no image blurring. If the job is done just with glass on a table top, use glass at least 3/16 inch thick so that its weight will press the materials flat. (The glass goes on top of the yellow sheeting.) You can use a Photo-flood lamp to give quicker exposures. The exposure time will vary, depending on the type of lamp and the distance, but it will usually be several minutes. To test, use small strips of film until the proper time is determined. The developed film should show dense black lines but the white will usually not be pure white, which does not matter. Strive for the biggest contrast.

Almost any developer can be used. Ordinary paper developer does not, however, give particularly good contrast. Kodagraph developer is satisfactory, but Kodalith developer gives even better contrast and is ideal. Use a glass or enameled tray for the developer and fixer. (For details of the art, study the manufacturers' instructions. Ordinary Kodak Acid Fixer is fine for the second step. Let the film remain in the fixer about twice as long as is necessary for the yellowish dye on the nonemulsion side to clear. Then wash it by holding two corners and letting a stream of cold water run for a minute or so over each face of the film. Hang it up by a corner to dry.

When the film positive is dry, the film negative can be made. Almost any type of film can be used, but one which is very slow is better than the usual fast film. I use Kodalith Transparent Stripping Film simply because it's around for other purposes. Like almost all films except Autopositive it requires a darkened room (the room need not

be light-tight and very small amounts of light can be admitted from another room). With Autopositive film or paper ordinary room lights can be left on, though the film or paper should be handled with emulsion down or away from the lights to avoid more exposure than necessary.

To make the final film negative, arrange the materials as shown in Fig. 5. Viewed from the emulsion side the Autopositive film positive will have a reversed image, and the same should be true of the negative. With even slow films the exposure will be very short. And if the same light source used for making the positive is employed, it may be necessary to interpose something between light and materials to reduce the exposure. A sheet of typewriter paper without any flaws will work well. With the light box of Fig. 3, for instance, a 4-minute exposure is required for making the Autopositive film but the shortest possible flick of the switch is enough to make the negative. Even then a sheet of typewriter paper must be placed between the light and the Autopositive to prevent over-exposure.

One other possibility should be mentioned. It may be desirable to make a printed panel from a drawing larger than the final desired size. One way to do this without having the negative made outside is to have a glossy positive photostat of the final size made from the drawing. (This usually costs less than a dollar.) The photostat is sufficiently translucent if on ordinary paper to take the place of the Autopositive film in Fig. 5. Use it, however, with the emulsion side against the final film so that the film will have a reversed image. The bad point about photostats or any part of the process

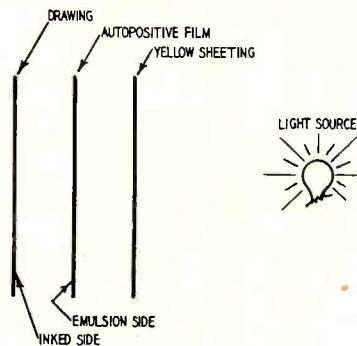

Fig. 4—Making a positive from original drawing.

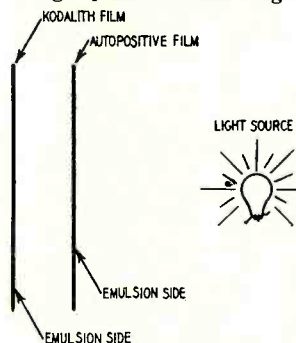

Fig. 5—Materials in making the final negative.

using photographic paper is that the paper will not hold its size and shape. The photostat method should be used only if exact finished size does not matter. Film holds its size well—though not perfectly—over a period of time.

Whatever film is used should be developed in whatever developer is recommended, using the highest-contrast procedure. Kodalith is good for stripping film as well as Autopositive. The finished film negative must have clear transparent lines (representing the conducting lines which will be left in metal on the finished panel) and be dense black in the areas which are to be etched out. Because of the high-contrast character of Kodalith Transparent Stripping Film it will give this result, even from a film positive which has gray in the "white" areas, if developed in Kodalith developer.

Remember to keep the room in which the developing is done dark. I use a bathroom, with the developer and fixer trays on the washstand. During the day a blanket is placed over the window, about 7 feet from the washstand, but at night nothing is necessary despite some light from neighboring windows. A light is left on some distance away in an adjoining room so that the developing film can be seen. As soon as it is put in the fixer, the lights can be turned on. When the negative has been developed, leave it in the fixer about twice as long as is necessary to clear the reddish dye from the rear. I judge this by holding up the film against the white bathroom tile and noting whether the white comes through the transparent areas untinted. Wash the film under running water for a couple of minutes and hang it up to dry by a corner.

TO BE CONTINUED

# it's reactance that counts

By H. P. MANLY

**T**RACING signal circuits while troubleshooting is largely a matter of following the paths of alternating currents and voltages through tubes, resistors and capacitors. Tubes are easy—signals go in at the grid or cathode and come out at the cathode or plate. Resistors cause no confusion. Obviously, a resistor marked 39,000 ohms opposes signal flow much more than another marked 680 ohms.

But when signal current or voltage divides between a resistor and a capacitor, which way will most of it go? The answer isn't always easy. How a signal divides depends on the relation between ohms of resistance in one path and ohms of capacitive reactance in the other path. To visualize the relative oppositions to signal flow in capacitors and resistors, values of both should be in ohms. You have to think of a capacitor as providing so many ohms of reactance.

Although reactance is the all-important thing in two-thirds of the capacitors in a receiver, they cannot be marked in ohms for reactance varies with frequency. A 100- $\mu$ f capacitor in carrier-signal circuits of a TV tuner would have a reactance of approximately 7 to 30 ohms, depending on the v.h.f. channel received. Were the same capacitor put into audio signal circuits its reactance would be 300,000 to 16,000,000 ohms, depending on the audio frequency.

Any value of capacitance may be translated into equivalent reactance by putting the capacitance and the frequency of operation into suitable formulas—but formulas are time consuming. Reactance values accurate enough for practical purposes may be read directly

from the charts by laying a straightedge at capacitance on one scale, at operating frequency on another scale, then reading reactance where the straightedge crosses the third scale.

To learn how much capacitance is needed to provide a certain reactance at a given frequency, put the straightedge on scales for reactance and frequency and read capacitance on the third scale. To determine the frequency at which a known capacitance will provide a desired reactance put the straightedge on the known capacitance and reactance.

Figs. 1 to 4 are circuit diagrams illustrating a few capacitor applications where reactance is the important characteristic. On each diagram these capacitors (coded C) are marked with subscript letters which identify their functions: *a*, blocking; *b*, bypassing; *c*, decoupling; *d*, coupling; *e*, tone compensation; *f*, voltage division; *g*, signal injection.

The following paragraphs carry letters corresponding with those for capacitors on the diagrams. All values

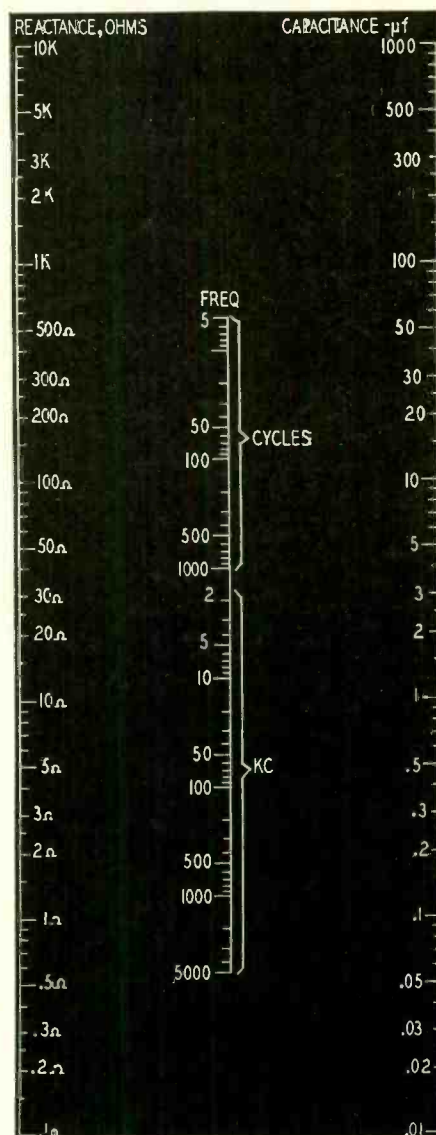

Reactance chart for 0.1 to 10,000 ohms.

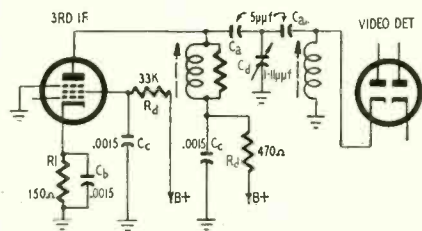

Fig. 2—Diagram of an i.f. amplifier.

given in the examples are approximate. Since most receiver capacitors have tolerances of 10%, with only a few as good as 5%, precise values are not called for. The symbol  $X_c$  stands for capacitive reactance.

Operating frequencies for each diagram are: audio, 100 to 5,000 cycles; TV horizontal sync, 15.75 kc; TV i.f. amplifier (average), 43 mc; TV tuner (low-band average) 70 mc; TV tuner (high-band average) 195 mc.

### A. Blocking

A blocking capacitor protects one circuit, usually a grid circuit, from d.c. voltage in another circuit, usually a plate circuit. These capacitors pass sig-

nal currents but their reactances oppose the signals to a greater or less extent.

Blocking capacitors reduce low-frequency gain in audio amplifiers. The capacitor at  $C_a$  of Fig. 1 opposes 100-cycle signals with about 160,000 ohms of reactance, but opposes 5,000-cycle signals with only about 3,200 ohms.

Blocking capacitors ( $C_a$ ) in i.f. amplifier and tuner circuits (Figs. 2, 3) usually have reactances too small to attenuate signals seriously. Approximate reactances for the two diagrams are:

5 $\mu$ f, 43 mc	= 740 ohms
22 $\mu$ f, 70 mc	(low band) = 100 ohms
22 $\mu$ f, 195 mc	(high band) = 37 ohms
12 $\mu$ f, 70 and 195 mc	= 190 and 68 ohms

### B. Bypassing

A capacitor for bypassing allows a large fraction of signal current to flow around a resistance or impedance whose opposition is not wanted in the signal path. The most familiar bypasses are around cathode resistors. Signal cur-

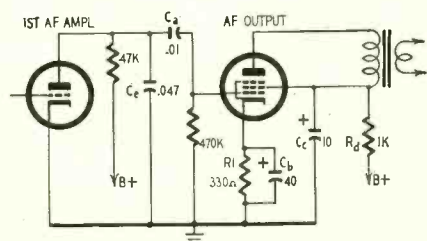
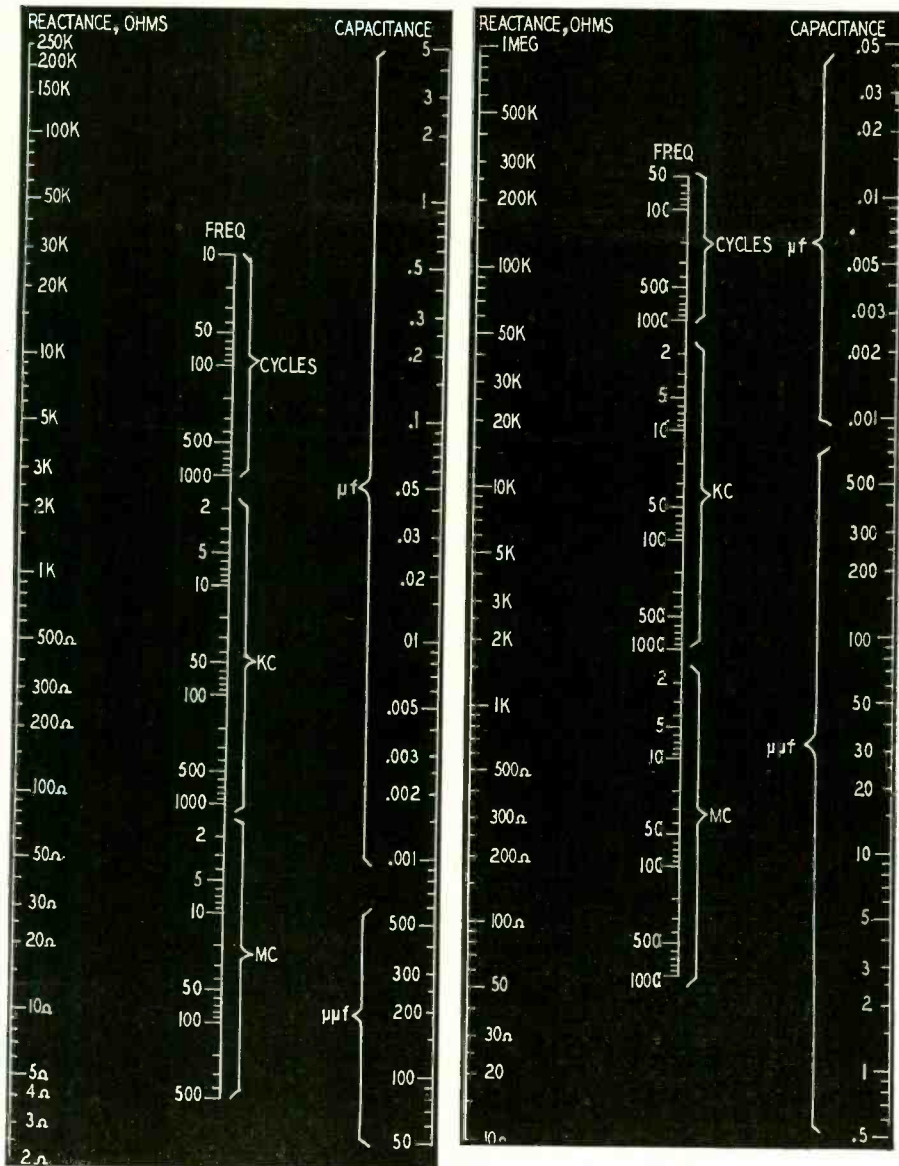

Fig. 1—Diagram of audio amplifier.



Reactance chart for 2 to 250,000 ohms.

rents not bypassed and flowing through the resistor cause degeneration and reduction of gain. Degeneration may be desired to improve wide-band frequency response or reduce distortion.

In Figs. 1 and 2, note the following:

Frequency	$C_b$ ( $\mu f$ )	$X_c$ (ohms)	$R_1$ (ohms)	Not bypassed
100 cycles	40	40	330	11%
5,000 cycles	40	0.8	330	0.2%
43 mc	.0015	2.5	150	1.6%

**C. Decoupling**

Capacitors for decoupling provide small-reactance paths between the

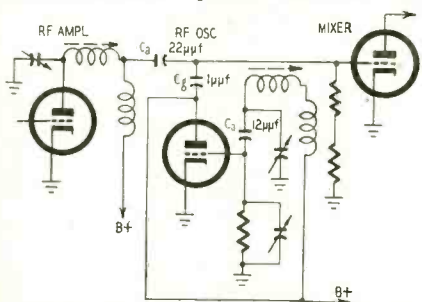

Fig. 3—Simplified oscillator circuit.

Reactance chart for 10 ohms to 1 megohm.

cathode of a tube and the low sides of its screen grid and plate circuits, also between screen and cathode. Decoupling capacitors are used in conjunction with decoupling resistors marked  $R_d$  in Figs. 1 and 2. The resistors oppose the flow of signal currents between decoupled elements and B supply circuits used also for other stages.

In Figs. 1 and 2, conditions are as follows:

Frequency	$C_c$ ( $\mu f$ )	$X_c$ (ohms)	$R_d$ (ohms)	Signal through $C_c$
100 cycles	10	160	1,000	86%
5,000 cycles	10	3.2	1,000	99.7%
43 mc	.0015	2.5	33,000	99.9%
43 mc	.0015	2.5	470	99.5%

Signal currents returning to cathodes pass from decoupling capacitors to ground and from ground through cathode resistors and their bypasses. Added opposition in cathode lines does not greatly affect decoupling.

**D. Coupling**

Coupling capacitor  $C_d$  of Fig. 2 is in the output or plate circuit of the ampli-

fier and also in the input or cathode circuit of the detector. Signal voltages across the reactance of this capacitor are in both circuits, coupling the circuits for signal transfer. Coupling is adjustable. At 43 mc the minimum capacitance of 1  $\mu f$  provides a reactance of about 3,700 ohms for maximum coupling; maximum capacitance of 11  $\mu f$  provides about 330 ohms for minimum coupling.

**E. Tone compensation**

Blocking capacitors oppose and attenuate low frequencies more than high frequencies. A compensating effect is produced by increasing the plate load of the first a.f. amplifier of Fig. 1 at the lower frequencies, thus increasing gain at these frequencies. The effective plate load consists of 47,000 ohms in parallel with the reactance of capacitor  $C_e$ . The plate load increases when the opposition of blocking capacitor  $C_a$  increases.

**F. Voltage division**

Capacitors in series divide an applied alternating voltage proportionately to the reactances. Capacitors  $C_{r1}$  and  $C_{r2}$  of Fig. 4, in series between the horizontal oscillator plate and ground, form the drive control for the horizontal output amplifier. The fraction of oscillator voltage across the adjustable capacitor is applied to the amplifier grid. It works out as follows:

Drive	$C_{r2}$ ( $\mu f$ )	Reactance of $C_{r2}$ (ohms)	Reactance of $C_{r1}$ (ohms)	Grid Input
Max.	40	250,000	22,000	92%
Min.	450	23,000	22,000	51%

Many miniature tubular capacitors are rated for only 200 working volts,

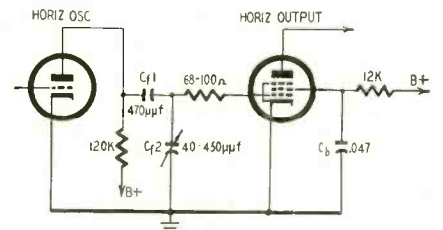

Fig. 4—Simplified horizontal drive—parts not needed in example left out.

some for only 100. If a small-capacitance low-voltage unit is in series with a relatively large capacitance, the small one may get too much voltage. Should there be any doubt, determine the reactances. Then divide the larger reactance by the sum of the reactances to find the fraction of total applied voltage across the smaller capacitance.

**G. Signal injection**

The 1- $\mu f$  capacitor  $C_g$  of Fig. 3 allows oscillator voltage to enter the mixer grid circuit, at the same time blocking the oscillator d.c. plate voltage. Reactance at the middle of the low band is about 2,300 ohms and for the high band about 820 ohms. This voltage is strong enough that these reactances cause no serious attenuation. The very small capacitance avoids upsetting tuning of the high-frequency circuits. END

By I. QUEEN  
EDITORIAL ASSOCIATE

# A TRANSISTOR **d.c.** TRANSFORMER



Front view—neon lamp acts as indicator.

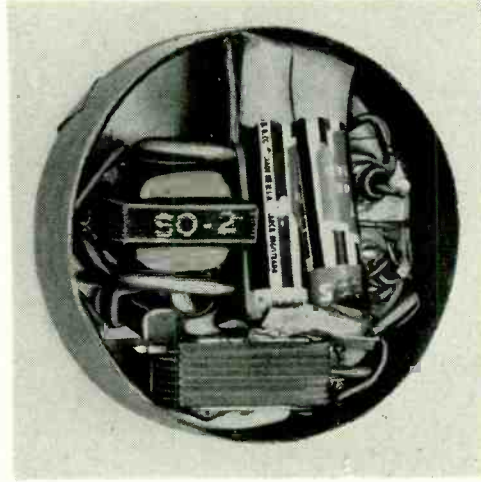

Inside view—components are miniaturized.

**A** BATTERY is a low-impedance source of power. It is most efficient and economical when supplying low voltage at high current. For example, a single No. 6 dry cell may be discharged at a rate of 2 watts or more, yet have a reasonable life span. Compare this with a penlight cell which has a recommended discharge rate of only 35 mw. Sixty penlight cells produce the same power output as a single No. 6 cell which costs about 66c. The 60 cells cost \$6.60.

The cost of battery power could be drastically cut with the aid of a "d.c. transformer." Such a device should have a low-impedance input to match the battery source and a high-impedance output to match a high-impedance load. For example, we might take 1 ma from a single size-N cell. With a 1:10 d.c. transformer (and no losses) the output would be 15 volts at 100  $\mu$ a. The N cell would hardly feel its light load and it would last many hundreds of hours. Yet it would provide the equivalent of a small 15-volt battery. The N cell costs 6c. The smallest 15-volt battery listed in the catalogs (size Y10) sells for 72c. If our load required only the 100  $\mu$ a assumed above, the single N cell would be sufficient.

A d.c. transformer has other advantages. The circuit, having limited power input, cannot produce dangerous voltage or current peaks. Short circuits or wiring errors cannot blow out delicate filaments or endanger instruments in associated circuits. Furthermore, in many cases one or two dry cells are already available for other purposes, such as energizing a filament, and can be used to furnish power.

Fig. 1 shows basic elements of a transformation circuit, which converts the d.c. from a battery to a.c. This may be a transistor audio or ultrasonic oscillator. The a.c. is stepped up as required, then rectified. A transistor is a logical choice for d.c. to a.c. conversion because of its efficiency and small size. Voltage multiplication and rectification can be combined with a voltage doubler.

In designing a transistor oscillator the first circuit that comes to mind is a Hartley with a center-tapped coil. A push-pull transformer is used. The tapped winding becomes the Hartley tank. The other coil is thus freed for a.c. only and for matching the impedance of the load.

This scheme did not work, the main difficulty being there is no satisfactory push-pull transformer in the price and size range desired. But there are plenty of miniature single-ended audio transformers listed in the catalogs, so one of these was used in the electronic transformer.

Fig. 2 shows the final circuit. It is a conventional audio oscillator with a capacitor isolating the secondary. This gives a series-resonant network which can step up voltage. The potential across the coil or capacitor is many times greater than the total voltage between emitter and base. To light a neon lamp I took the voltage across the 240- $\mu$ mf capacitor which has been multiplied more than 10 times and fed it to the voltage doubler.



Fig. 1—Functions of d.c. transformer.

As C is reduced, the oscillator frequency rises and so does the stepped-up voltage. If C is made too small, oscillations cease altogether. A small capacitor here may also send the frequency above audibility. The base resistor is another component that may call for trial and error. The smaller it is, the greater the current through the transistor. With a CK722, the maximum flow should not exceed 5 ma. The smaller this resistor, the greater the output power. With the values shown in Fig. 2, the input to the transistor is about 3.8 ma.

After completing the instrument, it may be tested to find the optimum load by connecting various resistors across the output while measuring output voltage and current. The product of these two gives output power. The results obtained, with two type N cells as the supply source, are shown below.

Load (megohms)	Output		
	volts	$\mu$ a	mw
0.12	17	150	2.6
0.18	23	130	3.0
0.22	28	125	3.5
0.27	30	110	3.3
0.33	32	95	3.0
0.62	40	74	2.9
1.10	45	50	2.3

Optimum power is obtained with a load of about 220,000 ohms.

The open-circuit voltage is nearly 70. Short-circuit current is about 350  $\mu$ a. Maximum output power is 3.5 mw for an input of about 10 mw.

Ripple is present in this circuit, but for most applications this is not a problem. If pure d.c. is necessary, an R-C filter may be added. A large capacitor

(.01 or 0.1  $\mu$ f) across the output terminals will also help. If the frequency is above audibility, it cannot cause difficulty in any audio circuit.

Most diodes pass considerable current in the reverse direction. For example,

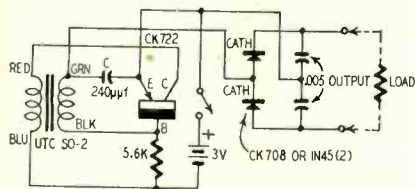

Fig. 2—Schematic of the transistor d.c. transformer—a CK722 unit is used. They may permit several hundred  $\mu$ a to flow at 50 volts. Since this instrument is a low-power affair, even the smallest drain lowers the output voltage considerably.

The output power of this circuit can be raised by using two diodes for each one shown in Fig. 2. Evidently this lowers the power lost through the rectifiers, for it permits higher output. If you have several rectifiers on hand, try them all—choose those that provide greatest output. You may find a considerable difference even among diodes of the same type.

Applications

This d.c. voltage multiplier is a low-power source but it has many applications. It can ignite a neon lamp, even though the power input is supplied by two tiny dry cells. Use either a NE-2 or NE-51 neon lamp. This gives just about the smallest, most economical source of illumination. The cells cost 12c a pair and will last 200 hours or more. The neon glow can be used for signaling, indicating, testing high insulation, etc.

Parts for d.c. transformer

- 1—5,600-ohm resistor; 1—240- $\mu$ f capacitor (see text); 2—.005- $\mu$ f disc capacitors; 1—CK722 transistor and holder; 2—penlight cells; 2—CK708 or IN45 diodes; 1—miniature audio transformer, 1:3 turns ratio, 10,000-ohm primary impedance, 90,000-ohm secondary impedance (UTC SO-2 or equivalent); 2—pin jacks; 1—s.p.s.t. switch.

The neon circuit is also useful for stroboscopic work since the lamp flashes on and off quickly and repeatedly as a result of the high d.c. potential breaking down the neon gas. Then the lamp begins to draw so much current that the voltage drops below the ignition point. The lamp is extinguished and ready for the next cycle.

The circuit has sufficient power for phototubes. Most gas types (like those used for movie sound) require approximately 70 volts at about 5  $\mu$ a. If the phototube is used for audio work, the ripple should be kept very low.

I have used this circuit to power a transistor r.f. oscillator. The CK722 transistor would not function with less than 10 volts. It took off immediately when connected to the d.c. voltage multiplier. Still another application is as a voltage source to calibrate and test vacuum-tube voltmeter instruments and scopes.

END

# ELECTROLYSIS PROBLEM

By J. PERKINSON, JR.

I WAS recently called upon to service a small twin-engine boat that showed signs of excessive salt-water electrolysis on the zinc housing anode of the port propeller shaft. A second zinc anode on the starboard side showed little corrosion. (For some reason skippers all believe electrolysis is a job for the marine radio technician.)

All metallic equipment on board was bonded to a common strap which ran to a 6-inch-wide copper strip above the water line. The strip then ran along the underside of the hull to a ground plate on the keel. I installed a second copper ground plate 1 x 12 feet on the other side of the keel and bonded its mid-section with a large brass bolt to the other ground plate. After a week of coastal fishing runs, the boat was put back in dry dock. One look told me that the extra grounding plates had not improved the situation—the zinc anode on the port propeller-shaft housing was deteriorating rapidly.

Zinc anode should last for a year. This one looked like it had had its year, after one week of fishing. Zinc anodes cost approximately \$8. Their function is to centralize the various electrical currents by providing a low-resistance path between the metallic components on the hull and the salt-water ground. This reduces the electrolysis action on these components and extends their life. I have seen costly propellers and shafts almost eaten away when zinc anodes were either not used or not inspected periodically and replaced.

I made low-resistance checks with a v.t.v.m. between the keel grounding plates and inside hull bonding to the engines and all metallic installations, but found nothing extraordinary. Low-resistance measurements were made to check the electrical bonding of the zinc anodes to both propeller housings and rudders, but still nothing significant could be found. The readings on the v.t.v.m. were so low that I was on the verge of constructing a very-low-resistance meter so that small resistance variations might be studied in greater detail.

Impurities in the zinc anodes, especially small quantities of iron, may cause them to become inactive after a short period in salt water. But both zinc anodes on the boat were identical and from the same supplier, so that theory was out.

The boat's ignition system was of the

positive-ground type so I visited a boatyard to look at other zinc anodes to learn if this polarity ground gave more electrolysis trouble than the negative ground. The results were about even. One old skipper told me that he had seen the same trouble many times before and the only cure was the installation of a new engine. I went back and checked and double-checked the ignition systems and all engine grounds, but didn't find anything; so I quit and went back to speculation and theory.

The skipper said that the radio had been used very little during the recent week of fishing and I dropped the r.f. current theory. But for good measure I buffed clean both copper grounding plates on each side of the keel, cleaned and resoldered all ground connections from the keel to the inside hull. I forgot to put on goggles for the keel buffing and some copper dust got into my eyes. At the end of the day, I was cussing and in general pretty miserable about the whole thing.

While the boat was out on another trip, I wrote a Government agency for technical data on boat electrolysis. It appears that very little in the way of technical information has been made available to the public. I could not find a boat handbook or a manual on the subject and was referred by the Government agency to a private concern. They appeared interested, but wanted a life history and a volume of technical information for special analysis. I figured that if I could get that information, it would not be necessary for me to have it specially analyzed as I had found a number of answers by direct tests.

My final speculation was that a battery action was being set up somewhere between the port propeller shaft and its housing, and that iron was somewhere in the system. But both shaft and housing were brass. I asked a buddy of mine who had worked on boats about the metallic parts installed in the propeller-shaft packing or water seal between the outside and inside of the hull. He said "washers are used, usually made of brass, but sometimes galvanized."

That was the answer. Inspection revealed galvanized washers in the defective area. After their zinc plating had corroded, the situation was ripe for local action. The zinc anode and iron washers formed the dissimilar plates, and the sodium chloride made an excellent electrolyte. Installation of brass washers solved that one.

END

# YOUR RECEIVER

## *as an* AUDIO GENERATOR

*Need a tone generator for occasional use in the shack? If so, try this simple trick*

By FRED LINGEL, W2ZGY

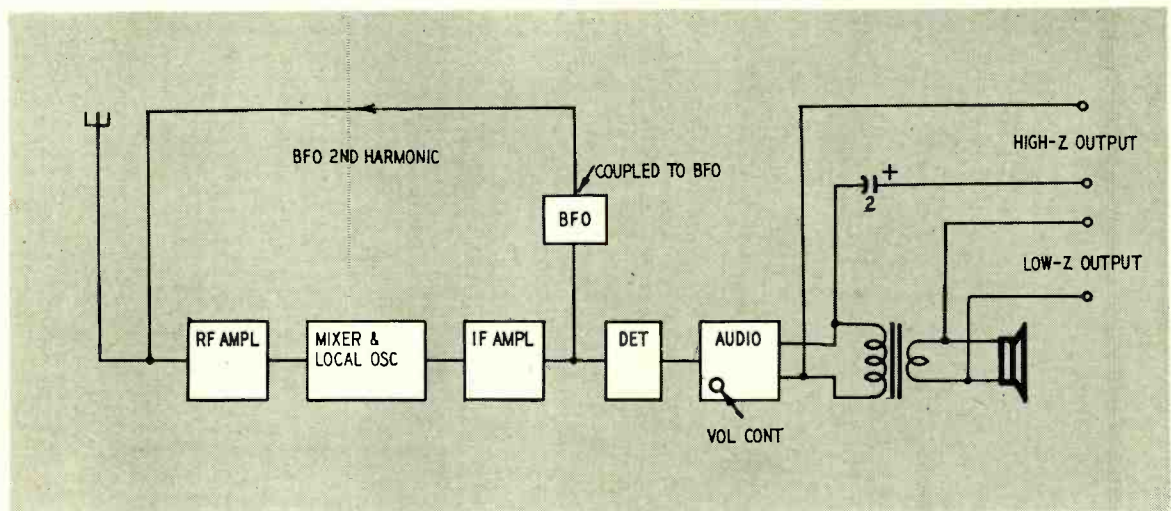

Block diagram of a receiver set up to operate as an audio oscillator.

A SHORTWAVE receiver can be used as an audio-frequency signal generator for modulation and other audio checks merely by feeding some of the b.f.o. second harmonic back to the antenna. To do this the beat-frequency oscillator output is capacitively coupled to the antenna connection of the receiver. This can be done either by wrapping a section of hookup wire around the tube or by inserting an insulated section of hookup wire into the oscillator coil can. If greater coupling is necessary because of low signal output, the antenna can be coupled directly to the plate pin of the b.f.o. through a 100- $\mu$ f capacitor. Turning on the b.f.o. or CW oscillator and tuning to or near the b.f.o. second harmonic produces a variable-frequency audio signal in the speaker.

The principle of operation is: If the i.f. of the receiver is 453 kc, and the b.f.o. is set at zero beat then the b.f.o. will generally have a very strong second harmonic at 906 kc. By coupling this signal back to the antenna terminal and tuning the receiver to around 906 kc (in the broadcast band) a signal will be heard in the loudspeaker. The frequency of this signal can be adjusted from near 0 to 20 kc or higher, depending upon the receiver components, the

loudspeaker, etc. This can be done by varying either the main tuning dial or the CW pitch control.

If the main tuning dial is used to adjust the signal, the approximate frequency can be determined from the dial markings of the receiver. For example, if zero beat is obtained at exactly 906 kc on the receiver tuning dial, then at the 911-kc mark the output will be 5,000 cycles, at 916 kc it will be 10,000 cycles, etc. This is based on a 453-kc i.f., a second harmonic at 906 kc, the receiver local oscillator operating on the high side of the input signal and the CW pitch control at zero.

Similar frequencies will also be obtained when the receiver dial is tuned to the low side of 906 kc, that is 0, 1,000, 2,000 and 3,000 cycles of audio will also be obtained at the 906-, 905-, 904- and 903-kc dial settings.

This system provides an audio voltage at a low impedance, around 5 ohms, from across the speaker coil. In addition, a high impedance, around 5,000 ohms, through a 2- $\mu$ f external coupling capacitor can be obtained from the plate of the output tube. In addition to these two output impedances, an audio signal can be obtained directly from the loudspeaker. In this way sound may be applied to a microphone for an over-all

response check of the audio system. The receiver, arranged as an audio signal generator, is shown in the block diagram.

The volume control of the receiver acts as a level control. An external rectifier type a.c. voltmeter can be connected across the output to measure the approximate amplitude of a.c. voltage for audio checks. Most multimeters set to read a.c. output voltages on a lower voltage range will give a fair measure of the a.c. voltage. Higher-voltage a.c. ranges may be considerably in error because of the distributed-capacitance shunt effect across the multiplier resistors. This is especially noticeable on the 5,000-ohm-per-volt (and higher) a.c. rectifier voltmeters. If a v.t.v.m. is used to check the audio system, it should be realized that these are generally peak-reading instruments and distortion in the waveform may cause considerable error in output level readings.

This generator has served very well for modulation checks in my amateur station. While it is not a final answer by any means, it is certainly a lot better than trying to whistle a prolonged 2,000-cycle constant-level note. Too, you can send code to the Jr. Op with a key across the b.f.o. switch. **END**





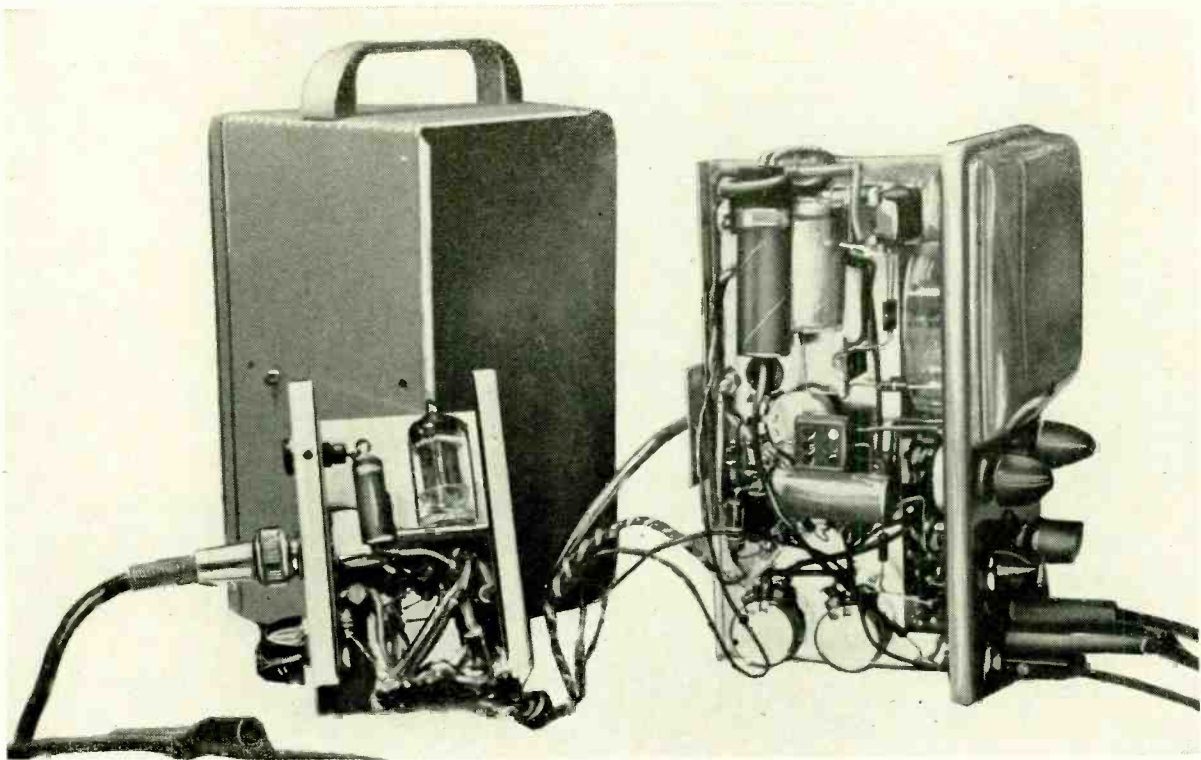

Underchassis view of the milvamp shows connection to the v.t.v.m.

the B plus voltage should be limited to 75 by using a larger filter resistance in place of the added 10,000-ohm unit in the v.t.v.m. The effect of increasing voltage above this value would not be detrimental to the operation of the milvamp, but it might impose too large a load on the v.t.v.m. voltage divider for stable v.t.v.m. operation. My arrangement did not alter the stability or calibration of the vacuum-tube voltmeter to any measureable extent.

The voltage divider for the milvamp is a 1-megohm audio-taper potentiometer. The pot was used for simplicity and economy. Points were marked on the front of the panel corresponding to settings for .015, .05, 0.15, and 0.5 volt.

#### Calibration

The basic calibration is the setting of the 10,000-ohm feedback control so that the v.t.v.m. reads full scale when 1/100 of the voltage required for full-scale deflection on the lowest v.t.v.m. range is applied to the milvamp. (The 1-megohm range control is set to maximum for the adjustment.) This may be done by calibrating against an audio voltmeter or by making up a calibration circuit as shown in Fig. 3. Measure the line voltage with the v.t.v.m. Then connect the v.t.v.m. to the arm of the 2,000-ohm potentiometer and adjust it to the point where 1/100 of the line voltage is read on the v.t.v.m. Thus, if the line voltage is 115, adjust the pot for a 1.15-volt meter reading. Then disconnect from the a.c. line *without* allowing the 2,000-ohm potentiometer arm to change position.

Connect the potentiometer as shown in Fig. 4. Adjust the 100-ohm potentiometer for full-scale v.t.v.m. reading between the common return and the arm of the 100-ohm pot on the lowest v.t.v.m. scale. Now plug the a.c. v.t.v.m. probe into the milvamp output jack and connect the milvamp input probe to the arm of the 2,000-ohm pot. Adjust the feedback control for full-scale deflection of the meter. This procedure establishes proper amplifier gain.

To calibrate the milvamp 1-megohm range control for the 1/10 range (0.15 volt if the v.t.v.m. full-scale reading is 1.5 volts), simply rotate the control until the v.t.v.m. reading decreases to 1/10 of full scale. Mark the point on the milvamp chassis adjacent to the pointer hairline. The appropriate voltage range designation may be lettered in India ink opposite the mark. The same procedure may be used for calibrating other range marks. If you have precision resistors you may wish to use a range switch in preference to the potentiometer.

The 1-megohm range pot should be an audio taper type for easy calibration. The milvamp input lead should be shielded. Return all ground leads to a common point on the milvamp chassis and connect this point to the grounded

input terminals on the v.t.v.m. If the meter needle does not return to zero when the input leads are shorted, check to be sure that the heater leads are dressed against the milvamp chassis. It may be necessary in some cases to reverse the milvamp heater connections at the v.t.v.m. Be careful to push the voltage supply leads into the v.t.v.m. cabinet where they will not short when

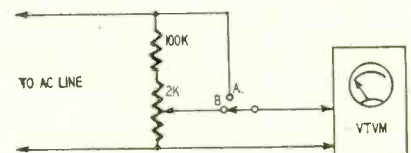

Fig. 3—Simple calibration circuit.

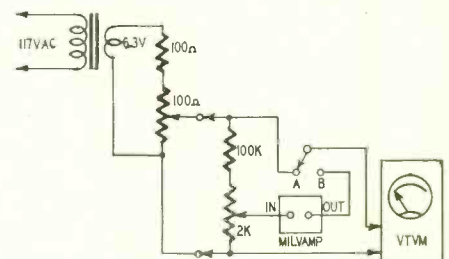

Fig. 4—Adjusting the amplifier gain.

the vacuum-tube voltmeter is placed in the cabinet.

The milvamp extends the usefulness of the standard v.t.v.m. and makes the measurement of small audio voltages possible. It may also be used as an auxiliary preamplifier for other purposes, without any changes in its circuitry.

END

#### Parts for the milvamp

Resistors: 1—10,000, 3—470,000 ohms, 2—10 megohms, 1/2 watt; 1—10,000-ohm potentiometer; 1—1-megohm potentiometer (audio taper).  
Capacitors: 2—.05, 1—0.1 μf, 4—volts (Aerovox P-82 or equivalent); 1—40 μf, 150 volts, electrolytic.  
Miscellaneous: 1—12AX7 and socket; 2—connectors (input and output); 1—chassis 1 1/2 x 4 1/8 x 2 3/4 inches (ICA 29078 or equivalent); 2—terminal strips.

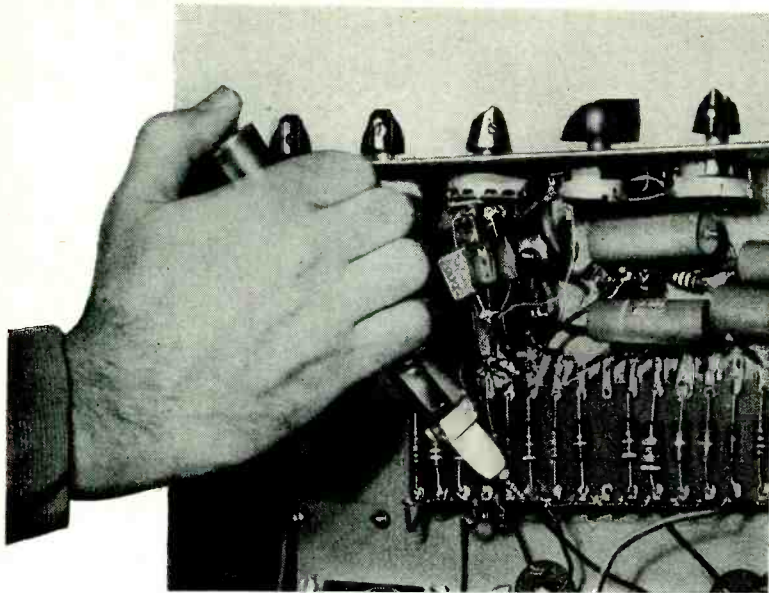

Using the signal injector probe

*Miniature audio oscillator serves as test instrument*

# Transistor Signal Injector

# PROBE

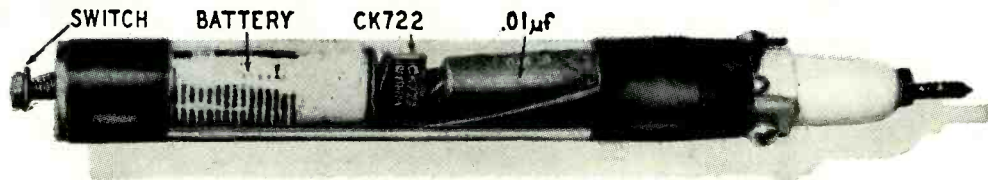

By HOMER L. DAVIDSON

CONSISTING of a CK722 Raytheon transistor, miniature interstage transformer, two small capacitors, one resistor and a hearing-aid B battery, this unit is actually an audio signal oscillator. All the small components are packed snugly in a plastic tube 5½ inches long.

At first a breadboard layout was used and various circuits were hooked up and tried before the finished product was built. A 1-megohm variable resistor was used in place of the 470,000-ohm unit R1, to bring the probe to oscillate at approximately 1,000 cycles. By varying this resistance and changing C1 different frequencies can be obtained.

The circuit (see diagram) is very simple and easy to wire. The CK722 collector is wired to the primary of the small UTC SO-3 interstage transformer. The other primary lead is soldered to the small hearing-aid battery and bias resistor. The base is connected to C1 and the resistor. The emitter is wired to one side of the secondary of the miniature transformer. If the unit does not oscillate, reverse the secondary connections. Coupling capacitor C2 isolates the injector probe from any high voltages and couples the injector signal into the circuit to be tested. There is no return or ground connection from the probe. To increase volume hold one hand on the chassis being tested while pressing firmly on the switch on the injector probe.

The 5½-inch plastic tube has a diameter of ¼ inch. It cannot be any smaller or the small transformer will not slide into it. The .01-µf capacitor, resistor

and transistor were soldered together first and placed in one end of the tube. Then the miniature transformer was soldered to them and pushed in. Capacitor C2 is soldered to the probe pointer, which is a long plastic bottle cap with a 6/32 bolt fastened to one end. To hold the pointer in place a hole was drilled through the cap and tube and a 6/32 bolt and nut put through it.

The only components left to mount are the hearing-aid battery and home-made switch. Solder the bias resistor return lead to the negative terminal of the battery and push the battery in place. The battery was inserted about ⅜ inch inside the plastic tube. Then the switch was soldered into place.

The switch is made of a ¼-inch diameter steel washer, a 6/32 bolt and nut, a small spring and copper strip. The small bolt was inserted through

the washer and the small spring put into place. The nut was then put on and snugged up so that the bolt would snap back into place when pushed. If the bolt is too long, saw the end off and solder over the nut so it will not come off.

The switch was soldered to the end of the plastic tube. To hold the washer in place a copper strip with a hole drilled in it was soldered to the washer and with a hot iron was pushed into the sides of the tube. Then by pressing down on the small bolt it makes contact with the top positive side of the hearing-aid battery.

The audio oscillator was tested with a small 1.5-volt penlight cell. The volume was fair but for stronger signal injections a 22½-volt hearing-aid battery was used. This transistor injector does not have a volume control but signal strength can be controlled somewhat by varying the capacitance coupling between the press switch and touching the chassis.

This transistor audio oscillator is useful in any equipment having audio trouble. In a television set the signal was injected in the discriminator stage and traced through to the speaker. Also, it can be used on shooting TV trouble in the home. The sound can easily be checked by inserting the nose of the probe into the phono jack, if one is provided. The unit can be used to check audio amplifiers and radio receivers. You can even place the probe on a voice coil, hold the other side with your hand and hear a trace of 1 kc coming through. END

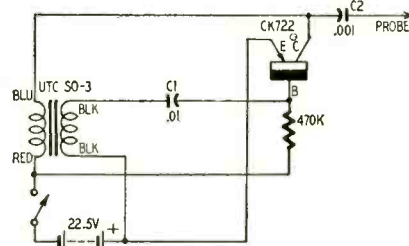

Schematic diagram of the probe.

#### Parts for signal injector

1—CK722 transistor; 1—miniature transformer, primary impedance 10,000 ohms, secondary impedance 200 ohms (UTC SO-3 or equivalent); 1—22.5-volt hearing-aid battery (Eveready 505E or equivalent); 1—.01-µf capacitor, 200 volts; 1—.001-µf capacitor, ceramic; 1—470,000-ohm ½-watt resistor; 1—switch (see text); 1—plastic tube, 5½ inches long, ¼-inch diameter; 1—pointer (see text).

# Heathkits

FOR THE ENTIRE ELECTRONICS INDUSTRY

*more than 65 top-quality models to choose from, including such outstanding kit designs as . . . . .*

**V-7A VACUUM TUBE VOLTMETER:** Easily the world's largest selling VTVM. Features peak-to-peak scales—etched metal circuit board—1% precision resistors—full wave rectifier and AC input circuit—reads rms and peak-to-peak AC, DC, and ohms.

**O-10 LABORATORY TYPE OSCILLOSCOPE:** The world's largest selling oscilloscope kit, and the most successful oscilloscope in history. Designed especially for color and black-and-white TV service work. Its 5 megacycle bandwidth and new 500 Kc sweep generator readily qualify it for laboratory applications. Features easy-to-assemble etched metal circuit board construction.

**WA-P2 HIGH FIDELITY PREAMPLIFIER:** This is the world's largest selling hi fi preamplifier kit. Features complete equalization, 5 separate switch-selected inputs with individual pre-set level controls, beautiful modern appearance, high-quality components.

**HIGH FIDELITY AMPLIFIERS:** Five Heathkit Models to choose from at prices ranging from \$16.95 to \$59.75. Power output range from 7 to 25 watts.

**DX-100 TRANSMITTER:** A 100 watt phone and CW ham transmitter, offering the greatest dollar value available in the ham radio field today.

*Greatest Dollar Value Through Factory-To-You Selling!*

**ONLY Heathkits CAN GIVE YOU ALL OF THESE DISTINCTIVE ADVANTAGES!**

- ▶ *The Most Complete Construction Manuals for Easy Assembly.*
- ▶ *Originality of Design—Developed Through Pioneering in the Kit Instrument Field.*
- ▶ *Greatest Dollar Value—Finest Quality with Real Economy.*
- ▶ *Direct Contact with Manufacturer—Lower Price, Guaranteed Performance.*
- ▶ *Etched Metal, Prewired Circuit Boards—Save Construction Time, Improve Performance.*
- ▶ *High Quality Standard Components for Long-Life Service.*

**HEATH COMPANY**

*A Subsidiary  
of Daystrom, Inc.*

**BENTON HARBOR 20, MICHIGAN**

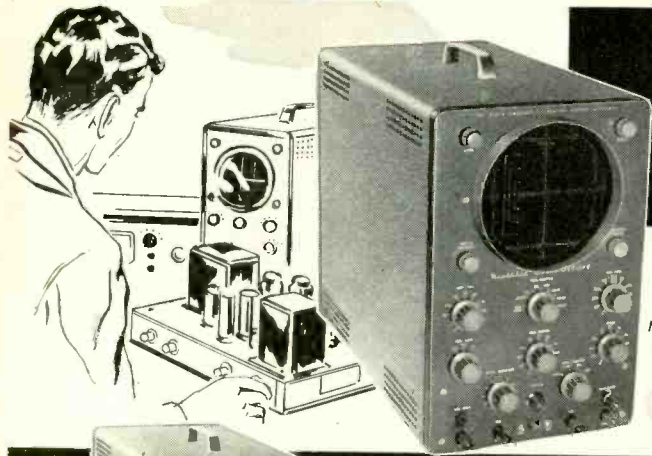

there is no substitute for  
**HEATHKIT QUALITY**

**YOU GET MORE:** All first-run, top quality parts—the latest in electronic design—complete and comprehensive step-by-step assembly instructions with large pictorial diagrams and assembly drawings. Proven performance through the production of thousands of kits.

MODEL O-10

1



2

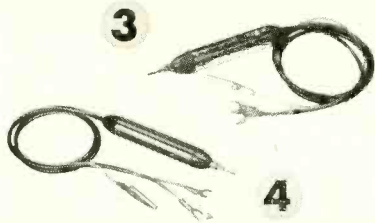

3

4



5

**1** Heathkit ETCHED CIRCUIT  
COLOR-TV  
**5" OSCILLOSCOPE KIT**

This deluxe quality oscilloscope has proven itself through thousands of operating hours in service shops and laboratories. Features the best in components—and the best in circuit design.

Features amplifier response to 5 Mc for color TV work, and employs the radically new sweep circuit to provide stable operation up to 500,000 cps. In addition, etched metal, pre-wired circuit boards cut assembly time almost in half, and permit a level of circuit stability never before achieved in an oscilloscope of this type.

Vertical amplifiers flat within +2 db -5 db from 2 cps to 5 Mc, down only 1½ db at 3.58 Mc. Vertical sensitivity is 0.025 volts, (rms) per inch at 1 Kc. 11 tube circuit employs a 5UP1 CRT.

Plastic molded capacitors used for coupling and bypass—preformed and cabled wiring harness provided.

Features built-in peak-to-peak calibrating source—retrace blanking amplifier—push-pull amplifiers and step-attenuated input.

MODEL O-10  
**\$6950**

Shpg. Wt. 21 Lbs.

**2** Heathkit ETCHED CIRCUIT  
**5" OSCILLOSCOPE KIT**

This is a general purpose oscilloscope for the more usual applications in the service shop or lab, yet is comparable to scopes costing many dollars more.

Features full size 5" CRT (5BP1), built-in peak-to-peak voltage calibration—3 step input attenuator—phasing control—push-pull deflection amplifiers—and etched metal pre-wired circuit boards.

Vertical channel flat within ±3 db from 2 cps to 200 Kc, with 0.09 V. rms/inch, peak-to-peak sensitivity at 1 Kc. Sweep circuit from 20 cps to 100,000 cps. A scope you will be proud to own and use.

MODEL OM-1  
**\$4950**

Shpg. Wt. 21 Lbs.

**3** Heathkit LOW CAPACITY  
**PROBE KIT**

Scope investigation of circuits encountered in TV requires the use of special low capacity probe to prevent loss of gain, circuit loading, or distortion. This probe features a variable capacitor to provide correct instrument impedance matching. Also the ratio of attenuation can be controlled.

NO. 342  
**\$350**

Shpg. Wt. 1 Lb.

**4** Heathkit ETCHED CIRCUIT  
**SCOPE DEMODULATOR PROBE KIT**

Extend the usefulness of your Oscilloscope by observing modulation envelope of R.F. or I.F. carriers found in TV and radio receivers. Functions like AM detector to pass only modulation of signal and not signal itself. Applied voltage limits are 30 V. RMS and 500 V. DC.

NO. 337-C  
**\$350**

Shpg. Wt. 1 Lb.

**5** Heathkit ETCHED CIRCUIT  
**3" OSCILLOSCOPE KIT**

This compact little oscilloscope measures only 9½" H. x 6½" W. x 11¾" D., and weighs only 11 lbs! Easily employed for home service calls, for work in the field or is just the ticket for use in the ham shack or home workshop. Incorporates many of the features of the Model OM-1, but yet is smaller in physical size for portability.

Employing etched circuit boards, the Model OL-1 features vertical response within ±3 db from 2 cps to 200 Kc. Vertical sensitivity is 0.25 V. RMS/inch peak-to-peak, and sweep generator operates from 20 cps to 100,000 cps. Provision for r.f. connection to deflection plates for modulation monitoring, and incorporates many features not expected at this price level. 8-tube circuit features a type 3GP1 Cathode Ray Tube.

MODEL OL-1  
**\$2950**

Shpg. Wt. 14 Lbs.

**HEATH COMPANY** A Subsidiary of Daystrom, Inc. **BENTON HARBOR 20, MICHIGAN**

# fill your test requirements WITH HEATHKITS

DESIGNED FOR YOU: Heath Company test equipment is designed for the maximum in convenience. Besides being functional, Heathkits represent the very latest in modern physical appearance, and incorporate all the latest circuit design features for comprehensive test coverage.

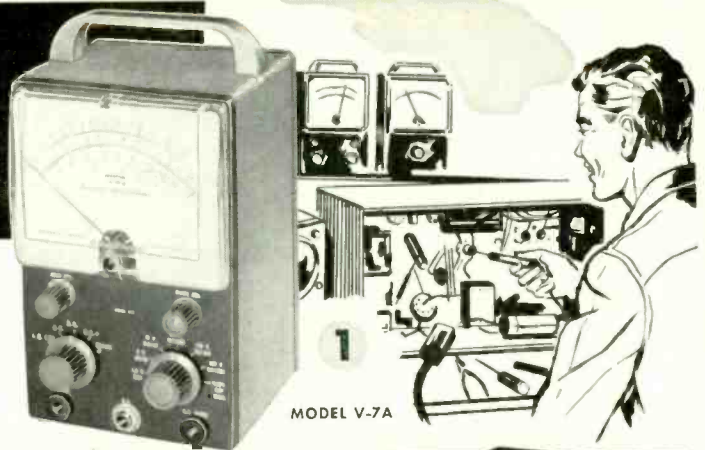

MODEL V-7A



2

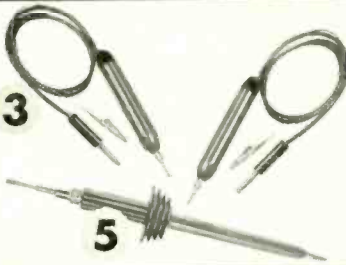

3

4

5

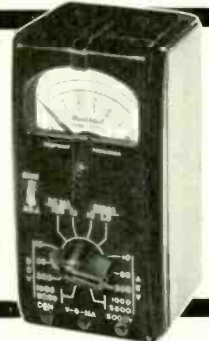

6

## 1 Heathkit ETCHED CIRCUIT VACUUM TUBE VOLTMETER KIT

Besides measuring AC (rms), DC and resistance, the modern-design V-7A incorporates peak-to-peak measurement for FM and television servicing.

AC (rms) and DC voltage ranges are 1.5, 5, 15, 50, 150, 500, and 1500. Peak-to-peak AC voltage ranges are 4, 14, 40, 140, 400, 1400, and 4000. Ohmmeter ranges are X1, X10, X100, X1000, X10K, X100K, and X1 megohm. Also a db scale is provided. A polarity reversing switch provided for DC measurements, and zero center operation within range of front panel controls. Employs a 200  $\mu$ a meter for indication. Input impedance is 11 megohms.

Etched metal, pre-wired circuit board for fast, easy assembly and reliable operation is 50% thicker for more rugged physical construction. 1% precision resistors for utmost accuracy.

MODEL V-7A

**\$24<sup>50</sup>**

Shpg. Wt. 7 Lbs.

## 2 Heathkit 20,000 OHMS/VOLT MULTIMETER KIT

The MM-1 is a portable instrument for outside servicing, for field testing, or for quick portability in the service shop. Combines attractive physical appearance with functional design. 20,000 ohms/v. DC, and 5000 ohms/v. AC. AC and DC voltage ranges are 0-1.5, 5, 50, 150, 500, 1500 and 5000 volts. Direct current ranges are 0-150  $\mu$ a., 15 ma., 150 ma., 500 ma., and 15 amperes. Resistance ranges are X1, X100, X10,000 providing center scale readings of 15, 1500 and 150,000 ohms. DB ranges cover -10 db to +65 db.

Features a 4 $\frac{1}{2}$ " 50  $\mu$ a. meter. Provides polarity reversal on DC measurements. 1% precision resistors used in multiplier circuits. Not affected by RF fields.

MODEL MM-1

**\$29<sup>50</sup>**

Shpg. Wt. 6 Lbs.

## 3 Heathkit ETCHED CIRCUIT RF PROBE KIT

The Heathkit RF Probe used in conjunction with any 11 megohm VTVM will permit RF measurements up to 250 Mc with  $\pm$  10% accuracy. Uses etched circuits for increased circuit stability and ease of assembly. Shpg. Wt. 1 Lb.

NO. 309-C  
**\$3<sup>50</sup>**

## 4 Heathkit ETCHED CIRCUIT PEAK-TO-PEAK PROBE KIT

Now read peak-to-peak voltages on the DC scale of any 11 megohm VTVM with this new probe, employing etched circuit for stability and low loss. Readings made directly from VTVM scales, from 5 Kc to 5 Mc. Not required for Heathkit Model V-7AVTVM. Shpg. Wt. 2 Lbs.

NO. 338-C  
**\$5<sup>50</sup>**

## 5 Heathkit 30,000 VOLT D.C. HIGH VOLTAGE PROBE KIT

For TV service work or similar application for measurement of high DC voltage. Precision multiplier resistor mounted inside plastic probe. Multiplication factor of 100 on the ranges of Heathkit 11 megohm VTVM. Shpg. Wt. 2 Lbs.

NO. 336  
**\$4<sup>50</sup>**

## 6 Heathkit HANDITESTER KIT

The Model M-1 measures AC or DC voltage at 0-10, 30, 300, 1000, and 5000 volts. Measures direct current at 0-10 ma. and 0-100 ma. Provides ohmmeter ranges of 0-3000 (30 ohm center scale) and 0-300,000 ohms (3000 ohms center scale). Features a 400  $\mu$ a. meter for sensitivity of 1000 ohms/volt. Because of its size, the M-1 is a very handy portable instrument that will fit in your coat pocket, tool box, glove compartment, or desk drawer. Makes a fine standby unit in the service shop when the main instruments are in use, or is ideal for the hobbyist or beginner. An unusual dollar value. Shpg. Wt. 3 Lbs.

MODEL M-1  
**\$14<sup>50</sup>**

**HEATH COMPANY**

A Subsidiary  
of Daystrom, Inc.

**BENTON HARBOR 20, MICHIGAN**

*Heathkit*  
TV ALIGNMENT  
**GENERATOR  
KIT**



1



2



3



4

**HEATH  
COMPANY**  
A SUBSIDIARY OF DAYSTROM INC.

The Model TS-4 features a controllable inductor for all-electronic sweep, improved oscillator and automatic gain circuitry, high RF output, center sweep operation, and improved linearity. It sets a new high standard for sweep generator operation, and is absolutely essential for the up-to-date service shop doing FM, black-and-white TV, and color TV work.

Voltage regulation and effective AGC action insure flat output over a wide frequency range. Electronic sweep insures complete absence of mechanical vibration. Sweep deviation controllable from 0 up to 40 Mc, depending upon base frequency. Effective two-way blanking.

Fundamental output from 3.6 Mc to 220 Mc in 4 bands. Crystal marker provides markers at 4.5 Mc and multiples thereof. Crystal included with kit. Variable marker covers from 19 Mc to 60 Mc on fundamentals, and up to 180 Mc on harmonics. Provision for external marker.



MODEL TS-4  
**\$49.50**  
Shpg. Wt. 16 Lbs.

1

*Heathkit* LINEARITY PATTERN  
**GENERATOR KIT**

The new-design Model LP-1 produces vertical or horizontal bar patterns, a cross-hatch pattern, or white dots on the screen of the TV set under test. No internal connections required. Special clip is attached to the TV antenna terminals. Instant selection of the pattern desired for adjustment of vertical and horizontal linearity, picture size, aspect ratio, and focus. Dot pattern presentation is a *must* for color convergence adjustments on color TV sets.

Extended operating range covers all television channels from 2 to 13. Produces 6 to 12 vertical bars or 4 to 7 horizontal bars.

MODEL LP-1  
**\$22.50**  
Shpg. Wt. 7 Lbs.

2

*Heathkit* LABORATORY  
**GENERATOR KIT**

The Heathkit Model LG-1 Laboratory Generator is a high-accuracy signal source for applications where metered performance is essential. It covers from 100 Kc to 30 Mc on fundamentals in 5 bands. Modulation is at 400 cycles, and modulation is variable from 0-50%. RF output from 100,000  $\mu$ v. to 1  $\mu$ v. 200  $\mu$ a. meter reads the RF output in microvolts, or percentage of modulation. Fixed step and variable output attenuation provided.

Features voltage regulation, and double copper plated shielding for stability. Provision for external modulation. Coaxial output cable (50 ohms).

MODEL LG-1  
**\$39.50**  
Shpg. Wt. 16 Lbs.

3

*Heathkit* CATHODE RAY  
**TUBE CHECKER KIT**

This new-design instrument holds the key to rapid and complete picture tube testing, either in the set, on the work-bench, or in the carton. Tests for shorts, leakage, and emission. Features Shadow-graph test (a spot of light on the screen) to indicate whether the tube is capable of functioning.

The Model CC-1 tests all electromagnetic deflection picture tubes normally encountered in television servicing. Supplies all operating voltages to the tube under test, and indicates the condition of the tube on a large "GOOD-BAD" scale. Features spring loaded test switches for operator protection.

The CC-1 is housed in an attractive portable case and is light in weight - ideal for outside service calls.

MODEL CC-1  
**\$22.50**  
Shpg. Wt. 10 Lbs.

4

*Heathkit* DIRECT READING  
**CAPACITY METER KIT**

Not only is this instrument popular in the service shop, but it has found extensive application in industrial situations. Ideal for quality control work, production line checking, or for matching pairs.

Features direct reading linear scales from 100 mmf to .1 mfd full scale. Necessary only to connect a capacitor of unknown value to the insulated binding posts, select the correct range, and read the meter. The CM-1 is not susceptible to hand capacity, and has a residual capacity of less than 1 mmf.

MODEL CM-1  
**\$29.50**  
Shpg. Wt. 7 Lbs.

**BENTON HARBOR 20, MICHIGAN**  
RADIO-ELECTRONICS

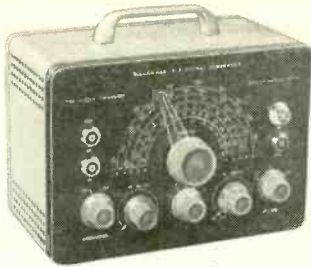

MODEL SG-8 \$1950  
Shpg. Wt. 8 Lbs.

This is one of the biggest signal generator bargains available today. The tried and proven Model SG-8 offers all of the outstanding features required for a basic service instrument. High quality components and outstanding performance.

The SG-8 covers 160 Kc to 110 Mc on fundamentals in 5 bands, and calibrated harmonics extend its usefulness up to 220 Mc. The output signal is modulated at 400 cps, and the RF output is in excess of 100,000 uv. Output controlled by both a continuously variable and a fixed step attenuator. Also, audio output may be obtained for amplifier testing. Don't let the

low price deceive you. This is a professional type service instrument to fulfill the signal source requirements in the service lab.

### 1 Heathkit . . . IMPEDANCE BRIDGE KIT

The IB-2 features built-in adjustable phase shift oscillator and amplifier, and has panel provisions for external generator. Measures resistance, capacitance, inductance, dissipation factors of condensers, and storage factor of inductance.

D, Q, and DQ functions combined in one control. 1/2% resistors and 1/2% silver-mica capacitors especially selected for this instrument. A 100-0-100 microammeter provides null indications. Two-section CRL dial provides 10 separate "units" with an accuracy of .5%. Fractions of units read on variable control.

MODEL IB-2 \$5950

Shpg. Wt. 12 Lbs.

# Heathkit SIGNAL GENERATOR KIT



### 2 Heathkit "Q" METER KIT

The Heathkit Model QM-1 will measure the Q of inductances and the RF resistance and distributed capacity of coils. Employs a 4 1/2" 50 microampere meter for direct indication. Will test at frequencies of 150 Kc to 18 Mc in 4 ranges. Measures capacity from 40 mmf to 450 mmf within ± 3 mmf. Indispensable for coil winding and determining unknown condenser values. A worthwhile addition to your laboratory at an outstandingly low price. Useful for checking wave traps, chokes, peaking coils, etc. Laboratory facilities are now available to the service shop and home lab.

MODEL QM-1 \$4450

Shpg. Wt. 14 Lbs.



### 3 Heathkit 6-12 VOLT BATTERY ELIMINATOR KIT

This modern battery eliminator will supply 6 or 12 volt output for ordinary automobile radios as well as 12 volts for the new models in the latest model cars. Output voltage is variable from 0-8 volts DC, or 0-16 volts DC. Will deliver up to 15 amperes at 6 volts, or up to 7 amperes at 12 volts. Two 10,000 microfarad filter capacitors insure smooth DC output. Two panel meters monitor output voltage and current. Will double as a battery charger. Definitely required for automobile radio service work.

MODEL BE-4 \$3150

Shpg. Wt. 17 Lbs.



### 4 Heathkit DECADE RESISTANCE KIT

Twenty 1% precision resistors provide resistance from 1 to 99,999 ohms in 1 ohm steps. Indispensable around service shop laboratory, ham shack, or home workshop. Well worth the extremely low Heathkit price.

MODEL DR-1 \$1950

Shpg. Wt. 4 Lbs.



### 5 Heathkit VIBRATOR TESTER KIT

Tests vibrators for proper starting and indicates the quality of the output on a large "GOOD-BAD" scale. Checks both interrupter and self-rectifier types in 5 different sockets. Operates from any battery eliminator delivering variable voltage from 4 to 6 volts DC at 4 amps. Ideal companion to the Model BE-4.

MODEL VT-1 \$1450

Shpg. Wt. 6 Lbs.



### 6 Heathkit DECADE CONDENSER KIT

Provides capacity values from 100 mmf to 0.111 mfd in steps of 100 mmf. ± 1% precision silver-mica condensers used. High quality ceramic switches for reduced leakage. Polished birch cabinet. Extremely valuable in all electronic activity.

MODEL DC-1 \$1650

Shpg. Wt. 3 Lbs.



BENTON HARBOR 20, MICHIGAN

# HEATH COMPANY

A SUBSIDIARY OF DAYSTROM INC.

# Heathkit TUBE CHECKER KIT

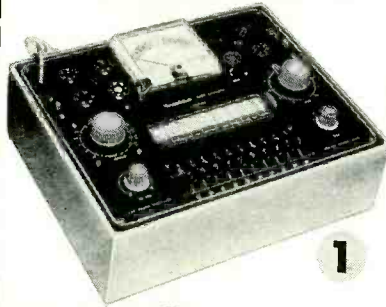

**1** The Heathkit Model TC-2 is an emission type tube tester that represents a tremendous saving over the price of a comparable unit from any other source. At only \$29.50, you can have a tube tester of your own, even if you are an experimenter, or only do part time service work. Extremely popular with radio servicemen, it uses a 4½" meter with 3-color meter face for simple "GOOD-BAD" indications that the customer can understand. Will test all tubes commonly encountered in radio and TV service work.

Ten 3-position lever switches for "open" or "short" tests on each tube element. Neon bulb indicates filament continuity or short between tube elements. Line adjust control provided. The roll chart is illuminated.

Sockets provided for 4, 5, 6, and 7-pin, octal, and loctal tubes, 7 and 9 pin miniature tubes, and the 5 pin Hytron tubes. Blank space provided for future socket addition. Tests tubes for opens, and shorts, and for quality on the basis of total emission. 14 different filament voltage values provided.

MODEL TC-2

**\$29.50**

Shpg. Wt. 12 Lbs.

## **2** Heathkit PORTABLE TUBE CHECKER KIT

The Model TC-2P is identical to the Model TC-2 except that it is housed in a rugged carrying case. This strikingly attractive and practical two-tone case is finished in proxylin impregnated fabric. The cover is detachable, and the hardware is brass plated. This case imparts a real professional appearance to the instrument. Ideal for home service calls, or any portable application.

MODEL TC-2P

**\$34.50**

Shpg. Wt. 15 Lbs.



## **3** Heathkit TV PICTURE TUBE TEST ADAPTER

The Heathkit TV picture tube test adapter is designed for use with the Model TC-2 Tube Checker. Test picture tubes for emission, shorts, and thereby determine tube quality. Consists of 12-pin TV tube socket, 4 ft. cable, octal connector, and necessary technical data. (Not a kit.)

MODEL 355

**\$4.50**

Shpg. Wt. 1 Lb.

## **4** Heathkit . . . CONDENSER CHECKER KIT

Use this Condenser Checker to quickly and accurately measure those unknown condenser and resistor values. All readings taken directly from the calibrated panel scales without any involved calculation. Capacity measurements in four ranges from .00001 to 1000 mfd. Checks paper, mica, ceramic and electrolytic condensers. A power factor control is available for accurate indication of electrolytic condenser efficiency. Leakage test switch—selection of five polarizing voltages, 25 volts to 450 volts DC to indicate condenser operating quality under actual load conditions. Spring-return test switch automatically discharges condenser under test and eliminates shock hazard to the operator.

Resistance measurements can be made in the range from 100 ohms to 5 meg-ohms. Here again, all values are read directly on the calibrated scales. Increased sensitivity coupled with an electron beam null indicator increases overall instrument usefulness.

For safety of operation, the circuit is entirely transformer operated. An outstanding low kit price for this surprisingly accurate instrument.

MODEL C-3

**\$19.50**

Shpg. Wt. 7 Lbs.



## **5** Heathkit VISUAL-AURAL SIGNAL TRACER KIT

This signal tracer is extremely valuable in servicing AM, FM, and TV receivers, especially when it comes to isolating trouble to a particular stage of the circuit under test.

This visual-aural tracer features a high gain RF input channel to permit signal tracing from the receiver antenna input clear through all RF, IF, detector, and audio stages to the speaker. Separate low-gain channel provided for audio circuit exploration. Both visual and aural indication by means of a speaker or headphone, and electron beam "eye" tube as a level indicator. Also incorporates a noise locator circuit for DC noise checks, and a built-in calibrated wattmeter (30-500 watts). Panel terminals provided for "patching" output transformer or speaker into external circuit for test purposes. Designed especially for the radio and TV serviceman. Cabinet size: 9½" wide x 6½" high x 5" deep. A real test equipment bargain.

MODEL T-3

**\$23.50**

Shpg. Wt. 9 Lbs.

# HEATH COMPANY

A SUBSIDIARY OF DAYSTROM INC.

BENTON HARBOR 20, MICHIGAN

RADIO-ELECTRONICS





MODEL HD-1

Shpg. Wt. 13 Lbs. **\$4950**

Used with a sine wave generator, the Model HD-1 will check the harmonic distortion output of audio amplifiers under a variety of conditions. Reads distortion directly on the meter as a percentage of the input signal. Operates between 20 and 20,000 cps. High impedance VTVM circuit for initial reference settings and final distortion readings. Ranges are 0-1, 3, 10, and 30 volts full scale. 1% precision resistors. Distortion scales are 0-1, 3, 10, 30 and 100% full scale. Requires only .3 volt input for distortion test.

# Heathkit HARMONIC DISTORTION METER KIT

## 1 Heathkit AUDIO ANALYZER KIT

This instrument consists of an audio wattmeter, an AC VTVM, and a complete IM analyzer, all in one compact unit.

Use the VTVM to measure noise, frequency response, output gain, power supply ripple, etc. Use the wattmeter for measurement of power output. Internal loads provided for 4, 8, 16, or 600 ohms. VTVM also calibrated for DBM units. High or low impedance IM measurements made with built-in 6KC and 60 cps generators. VTVM ranges are .01, to 300 volts in 10 steps. Wattmeter ranges are .15 mw. to 150 w. in 7 steps. IM scales are 1% to 100% in 5 steps.

MODEL AA-1  
**\$5950**

Shpg. Wt. 13 Lbs.



## 2 Heathkit AUDIO GENERATOR KIT

This new Heathkit Model features step-tuning from 10 cps to 100 Kc with three rotary switches that provide two significant figures and multiplier. Less than .1% distortion. Frequency accurate to within  $\pm 5\%$ .

Output monitored on a large  $4\frac{1}{2}$ " meter that reads voltage or db. Both variable and step-type attenuation provided. Meter reads zero-to-maximum at each attenuator position. Output ranges (and therefore meter ranges) are 0-.003, .01, .03, .1, .3, 1, 3, 10 volts. Step-tuning provides rapid positive selection of the desired frequency, and allows accurate return to any given frequency.

MODEL AG-9  
**\$3450**

Shpg. Wt. 8 Lbs.



## 3 Heathkit AUDIO OSCILLATOR KIT

(SINE WAVE — SQUARE WAVE)

The Model AO-1 features sine wave or square wave coverage from 20-20,000 cps in 3 ranges. It is an instrument specifically designed to completely fulfill the needs of the serviceman and high fidelity enthusiast. Offers high level output across the entire frequency range, low distortion and low impedance output. Features a thermistor in the second amplifier stage to maintain essentially flat output through the entire frequency range. Produces an excellent sine wave for audio testing, or will produce good, clean, square waves with a rise time of only 2 microseconds.

MODEL AO-1  
**\$2450**

Shpg. Wt. 10 Lbs.

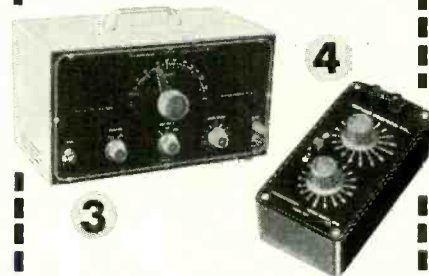

## 4 Heathkit RESISTANCE SUBSTITUTION BOX KIT...

Provides switch selection of 36 RTMA 1 watt standard 1% resistors ranging from 15 ohms to 10 megohms. Numerous applications in radio and TV work, and essential in the developmental laboratory.

MODEL RS-1  
**\$550**

Shpg. Wt. 2 Lbs.



## 5 Heathkit AC VACUUM TUBE VOLTMETER KIT...

The Heathkit AC VTVM features high impedance, wide frequency range, very high sensitivity, and extremely wide voltage range. Will accurately measure a voltage as small as 1 mv. at high impedance. Excellent for sensitive AC measurements required by laboratories, audio enthusiasts and experimenters. Frequency response is substantially flat from 10 cps to 50 Kc. Ranges are .01, .03, .1, .3, 1, 3, 10, 30, 100, and 300 v. RMS. Total db range -52 to + 52 db. Input impedance 1 megohm at 1 Kc.

MODEL AV-2  
**\$2950**

Shpg. Wt. 5 Lbs.

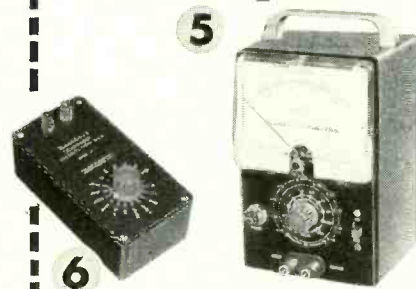

## 6 Heathkit CONDENSER SUBSTITUTION BOX KIT...

Very popular companion to Heathkit RS-1. Individual selection of 18 RTMA standard condenser values from .0001 mfd to .22 mfd. Includes 18" flexible leads with alligator clips.

MODEL CS-1  
**\$550**

Shpg. Wt. 2 Lbs.



BENTON HARBOR 20, MICHIGAN

**HEATH  
COMPANY**

A SUBSIDIARY OF DAYSTROM INC.



# HEATHKIT HAM GEAR

for high quality at moderate cost

**DOLLAR VALUE:** You get more for your Heathkit dollar because your labor is used to build the kit instead of paying for someone else's. Also, the middleman's margin of profit is eliminated when you deal directly with the manufacturer.

1

MODEL DX-100



2



3



4

## 1 Heathkit DX-100 PHONE & CW TRANSMITTER KIT

The reception given this amateur transmitter has been tremendous. Reports from radio amateurs using the DX-100 are enthusiastic in praising its performance and the high quality of the components used in its assembly. Actual "on the air" results reflect the careful design that went into its development.

The DX-100 features a built-in VFO, modulator, and power supplies, and is completely bandswitching for phone or CW operation on 160, 80, 40, 20, 15, 11, and 10 meters. All parts necessary for construction are supplied in the kit, including tubes, cabinet, and detailed step-by-step instructions. Easy to build, and a genuine pleasure to operate.

Employs push-pull 1625's modulating parallel 6146's for RF output in excess of 100 watts on phone and 120 watts on CW. May be excited from the built-in VFO or from crystals (crystals not included with kit). Features five-point TVI suppression: (1) pi network interstage coupling to reduce harmonic transfer to the final stage; (2) pi network output coupling; (3) extensive shielding; (4) all incoming and outgoing circuits filtered; (5) inter-locking cabinet seams to eliminate radiation except through the coaxial output connector. Pi network output coupling will match 50 to 600 ohm non-reactive load. Illuminated VFO dial and meter face. Remote control socket provided.

The chassis is made of extra-strong #16 gauge copper-plated steel. It employs potted transformers, ceramic switch and variable capacitor insulation, solid silver loading switch terminals, and high-grade well-rated components throughout. Features a pre-formed wiring harness, and all coils are pre-wound.

High-gain speech amplifier for dynamic or crystal microphones, and restricted speech range for increased intelligence. Plenty of audio power reserve. Measures 20 7/8" W. x 13 3/4" H. x 16" D. Schematic diagram and complete technical specifications on request.

MODEL DX-100  
**\$189.50**  
Shpg. Wt. 120 Lbs.

Shipped Motor Freight Unless Otherwise Specified  
\$50.00 Deposit Required on C.O.D. Orders

## 2 Heathkit VFO KIT

The Model VF-1 covers 160-80-40-20-15-11 and 10 meters with three basic oscillator frequencies. Better than 10-volt average RF output on fundamentals. Features illuminated and pre-calibrated dial scale. Cable and plug provided to fit crystal socket of any modern transmitter.

Enjoy the convenience and flexibility of VFO operation at no more than the price of crystals. May be powered from plug on the Heathkit Model AT-1 transmitter, or supplied with power from most transmitters. Measures: 7" H. x 6 1/2" W. x 7" D.

MODEL VF-1  
**\$19.50**  
Shpg. Wt. 7 Lbs.

## 3 Heathkit CW AMATEUR TRANSMITTER KIT

The Model AT-1 is an ideal novice transmitter, and may be used to excite a higher power rig later on.

This CW transmitter is complete with its own power supply, and covers 80, 40, 20, 15, 11, and 10 meters. Features single-knob bandswitching, and panel meter indicates grid or plate current for the final amplifier. Designed for crystal operation or external VFO. Crystal not included in kit. Incorporates such features as key click filter, line filter, copper-plated chassis, pre-wound coils, 52 ohm coaxial output, and high quality components throughout. Instruction book simplifies assembly. Employs a 6AG7 oscillator, 6L6 final amplifier. Operates up to 35 watts plate power input.

MODEL AT-1  
**\$29.50**  
Shpg. Wt. 15 Lbs.

## 4 Heathkit ... ANTENNA COUPLER KIT

The Model AC-1 will properly match your low power transmitter to an end-fed long wire antenna. Also attenuates signals above 36 Mc, reducing TVI. 52 ohm coax. input—power up to 75 watts—10 through 80 meters—tapped inductor and variable condenser—neon RF indicator—copper plated chassis and high quality components. Ideal for use with Heathkit AT-1 Transmitter.

MODEL AC-1  
**\$14.50**  
Shpg. Wt. 4 Lbs.

# "AMATEUR-ENGINEERED"

## Equipment For The Ham

MODERN DESIGN: You can be sure of getting all the latest and most desirable design features when you buy Heathkits. Advanced-design is a minimum standard for new Heathkit models.

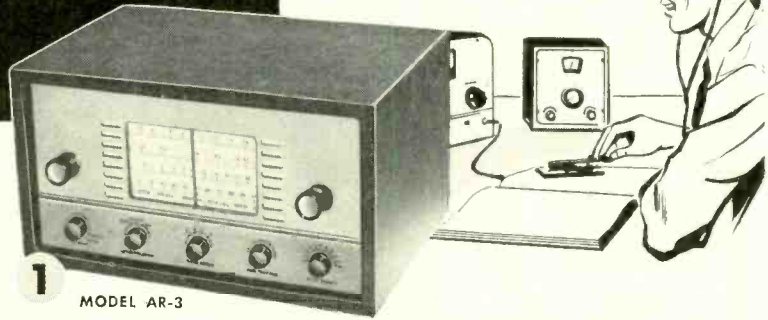

1  
MODEL AR-3

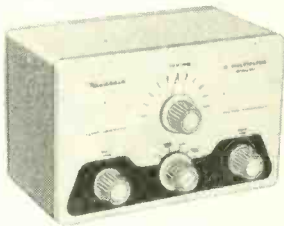

2



3



4



5

### 1 Heathkit COMMUNICATIONS-TYPE ALL BAND RECEIVER KIT

The new Model AR-3 features improved IF and RF performance, along with better image rejection on all bands. Completely new chassis layout for easier assembly, even for the beginner.

Covers 550 Kc to 30 Mc in four bands. Provides sharp tuning and good sensitivity over the entire range. Features a transformer-type power supply—electrical bandspread—separate RF and AF gain controls—antenna trimmer—noise limiter—AGC—BFO—headphone jacks—5½" PM speaker and illuminated tuning dial.

CABINET: Fabric covered cabinet with aluminum panel as shown. Part No. 91-15, shipping weight 5 lbs. \$4.50.

MODEL AR-3  
**\$27<sup>95</sup>**

Shpg. Wt. 12 Lbs.  
(Less Cabinet)

### 2 Heathkit "Q" MULTIPLIER KIT

Here is the Heathkit Q Multiplier you hams have been asking for. A tremendous help on the phone and CW bands when the QRM is heavy. Provides an effective Q of approximately 4,000 for extremely sharp "peak" or "null." Use it to "peak" the desired signal or to "null" an undesired signal, or heterodyne. Tunes to any signal within the IF band-pass of your receiver. Also provides "broad peak" for conditions where extreme selectivity is not required.

Operates with any receiver having an IF frequency between 450 and 460 Kc. Will not function with AC-DC type receivers. Requires 6.3 volts AC at 300 ma. and 150 to 250 VDC at 2 ma. Derives operating power from your receiver. Uses a 12AX7 tube, and special High-Q shielded coils. Simple to connect with the cable and plugs supplied. Measures only 4-11/16"H.x7¾"W.x4¼"D. A really valuable addition to the receiving equipment in your ham shack.

MODEL QF-1  
**\$9<sup>95</sup>**

Shpg. Wt. 3 Lbs.

### 3 Heathkit VARIABLE VOLTAGE REGULATED POWER SUPPLY KIT

Provides well filtered DC output, variable from zero to 500 volts at no load and *regulated* for stability. Will supply up to 10 ma. at 450 VDC, and up to 130 ma. at 200 VDC. Voltage or current monitored on front panel meter. Also provides 6.3 VAC at 4A. for filament. Filament voltage isolated from B+, and both isolated from ground. Invaluable around the ham shack for supplying operating potentials to experimental circuits. Use in all types of research and development laboratories as a temporary power supply, and to determine design requirements for ultimate power supply.

MODEL PS-3  
**\$35<sup>50</sup>**

Shpg. Wt. 17 lbs.

### 4 Heathkit ANTENNA IMPEDANCE METER KIT

Use in conjunction with a signal source for measuring antenna impedance, line matching, adjustment of beam and mobile antennas, etc. Will double as a phone monitor or relative field strength indicator. 100 µa. meter employed. Covers the range from 0-600 ohms. An instrument of many uses for the amateur.

MODEL AM-1  
**\$14<sup>50</sup>**

Shpg. Wt. 2 lb.

### 5 Heathkit GRID DIP METER KIT

This is an extremely valuable tool for accomplishing literally hundreds of jobs on all types of equipment. Covering from 2 Mc to 250 Mc, the GD-1B is compact and can be operated with one hand. Uses a 500 µa. meter for indication, with a sensitivity control and headphone jack. Includes prewound coils and rack. Indispensable instrument for hams, engineers, or servicemen.

MODEL GD-1B  
**\$19<sup>50</sup>**

Shpg. Wt. 4 lbs.

**HEATH COMPANY** A Subsidiary of Daystrom, Inc. **BENTON HARBOR 20, MICHIGAN**

*Heathkits*  
 PROVIDE THE  
 "CONSTRUCTIVE"  
 APPROACH TO  
**HIGH-FIDELITY**



**EASY TO BUILD:** *The assembly instructions supplied with Heathkits are so complete and detailed that anyone can assemble the kits without difficulty. Plenty of pictorial diagrams and step-by-step instructions. Information on resistor color codes, soldering, use of tools, etc. Build-it-yourself with confidence!*



**1** *Heathkit* **ADVANCED-DESIGN**  
**HIGH FIDELITY** **AMPLIFIER KIT**

The 25 Watt Model W-5 is one of the most outstanding high fidelity amplifiers available today—at any price. Incorporates the very latest design features to achieve true "presence" for the super-critical listener.

Features a new-design Peerless output transformer, and KT66 output tubes handle power peaks up to 42 watts. The unique "tweeter-saver" suppresses high frequency oscillation. A new type balancing circuit results in closer "dynamic" balance between output tubes. Features improved phase shift characteristics and frequency response, with reduced IM and harmonic distortion. Color styling harmonizes with the Heathkit WA-P2 Preamplifier and the FM-3 Tuner.

Frequency response—within  $\pm 1$  db from 5 cps to 160 Kc at 1 watt. Harmonic distortion only 1% at 25 watts, 20-20,000 cps. IM distortion only 1% at 20 watts, using 60 and 3,000 cps. Output impedance 4, 8, or 16 ohms. Hum and noise—99 db below rated output. Uses two 12AU7's, two KT66's and a 5R4GY.

**KIT COMBINATIONS:**

W-5M Amplifier Kit: Consists of main amplifier and power supply, all on one chassis. Complete with all necessary parts, tubes, and comprehensive manual. Shpg. Wt. 31 lbs. Express only.

**\$59<sup>75</sup>**

W-5 Combination Amplifier Kit: Consists of W-5M Amplifier Kit listed above plus Heathkit Model WA-P2 Preamplifier Kit. Complete with all necessary parts, tubes, and construction manuals. Shpg. Wt. 38 lbs. Express only.

**\$79<sup>50</sup>**

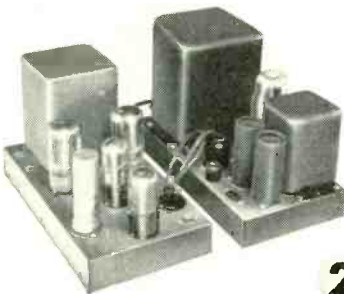

**2** *Heathkit* **DUAL-CHASSIS WILLIAMSON TYPE**  
**HIGH FIDELITY** **AMPLIFIER KIT**

This is a very popular high fidelity amplifier kit that features dual-chassis type construction. The resulting physical dimensions offer an additional margin of flexibility in installation. It features the famous Acrosound TO-300 "ultra-linear" output transformer, and has a frequency response within  $\pm 1$  db from 6 cps to 150 Kc at 1 watt. Harmonic distortion only 1% at 21 watts. IM distortion at 20 watts only 1.3% at 60 and 3,000 cps. Rated power output is 20 watts. Output impedance 4, 8, or 16 ohms. Hum and noise—88 db below 20 watts. Uses two 6SN7's, two 5881's, and a 5V4G.

**KIT COMBINATIONS:**

W-3M: Consists of main amplifier and power supply for separate chassis construction. Includes all tubes and components necessary for assembly. Shpg. Wt. 29 lbs., Express only.

**\$49<sup>75</sup>**

W-3: Consists of W-3M Kit listed above plus Heathkit Model WA-P2 Preamplifier described on opposite page. Shpg. Wt. 37 lbs., Express only.

**\$69<sup>50</sup>**



**3** *Heathkit* **SINGLE-CHASSIS WILLIAMSON TYPE**  
**HIGH FIDELITY** **AMPLIFIER KIT**

This is the lowest priced Williamson type amplifier ever offered in kit form, and yet it retains all the usual features of the Williamson type circuit. Main amplifier and power supply combined on one chassis, and uses a new-design Chicago output transformer. Frequency response—within  $\pm 1$  db from 10 cps to 100 Kc at 1 watt. Harmonic distortion only 1.5% at 20 watts. IM distortion at rated output, 2.7% at 60 and 3,000 cps. Rated power output is 20 watts. Output impedance 4, 8, or 16 ohms. Hum and noise—95 db below 20 watts. Uses two 6SN7's, two 5881's, and one 5V4G.

Instructions are so complete that the kit may be assembled successfully even by a beginner in electronics.

**KIT COMBINATIONS:**

W-4M: Consists of main amplifier and power supply for single chassis construction. Includes all tubes and components necessary for assembly. Shpg. Wt. 28 lbs. Express only.

**\$39<sup>75</sup>**

W-4A: Consists of W-4AM Kit listed above plus Heathkit Model WA-P2 Preamplifier described on opposite page. Shpg. Wt. 35 lbs. Express only.

**\$59<sup>50</sup>**

**HEATH  
 COMPANY**

A SUBSIDIARY OF DAYSTROM INC.

**BENTON HARBOR 20, MICHIGAN**

RADIO-ELECTRONICS

**ATTRACTIVELY STYLED:** *Heathkit high fidelity instruments are not only functional, but are most attractive in physical design. Such units as the preamplifier and the W-5 main amplifier are designed for beauty as well as performance. They blend with any room decor and are the kind of instruments you will be proud to own.*



*enjoy....*  
**THE VERY BEST  
 IN AUDIO WITH  
 "BUILD-IT-YOURSELF"  
 HEATHKITS**

**1** *Heathkit* HIGH FIDELITY  
**PREAMPLIFIER KIT**

This outstanding preamplifier is designed specifically for use with the Heathkit Williamson type amplifiers. It completely fulfills the requirements for remote control, compensation and preamplification, and exceeds even the most rigorous specifications for high fidelity performance.

Features five separate switch-selected input channels (2 low level and 3 high level), each with its own input control. Full record equalization with four-position turnover control and four-position rolloff control.

Output jack for tape recorder — separate bass control with 18 db boost and 12 db cut at 50 cps. — treble control offering 15 db boost and 20 db cut at 15,000 cps — special hum control to insure minimum hum level — and many other desirable features. Overall frequency response (with controls set to "flat" position) is within 1 db from 25 cps to 30,000 cps. Will do justice to the finest available program sources. Beautiful satin-gold finish.

Power requirements from the Heathkit Williamson type high fidelity amplifier — 6.3 VAC at 1 amp., and 300 VDC at 10 Ma. Uses two 12AX7's and one 12AU7.

MODEL WA-P2  
**\$1975**  
 Shpg. Wt. 7 Lbs.

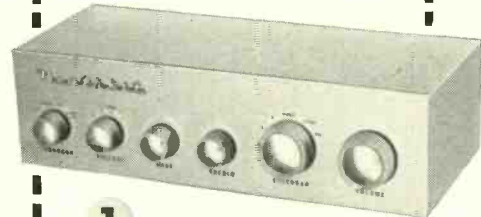

**1**

**2** *Heathkit* 20-WATT HIGH FIDELITY  
**AMPLIFIER KIT**

This Heathkit Model offers you the least expensive route to high fidelity performance. Frequency response is  $\pm 1$  db from 20-20,000 cps. Features full 20 watt output using push-pull 6L6's, and incorporates separate bass and treble tone controls. Preamplifier and main amplifier are built on the same chassis. Four switch-selected compensated inputs and separate bass and treble tone controls provide all necessary functions at minimum investment. Features miniature tube types for low hum and noise.

Uses 12AX7, two 12AU7's, two 6L6G's and a 5V4G. A most interesting "build-it-yourself" project, and an excellent hi-fi amplifier for home use. Well suited, also, for public address applications because of its high power output and high quality audio reproduction. Another Heathkit "best-buy" for you!

MODEL A-9B  
**\$3550**  
 Shpg. Wt. 23 Lbs.



**2**



**3** *Heathkit* 7 - WATT  
**AMPLIFIER KIT**

The redesigned Model A-7D features a new type output transformer for tapped screen operation, and provides improved sensitivity, reduced distortion, and increased power output.

The full 7-watt output of the Model A-7D is more than adequate for normal home installations. Frequency characteristics are  $\pm 1\frac{1}{2}$  db from 20 to 20,000 cps. Potted output and power transformers employed. Push-pull output — detailed construction manual — top quality parts — high quality audio without great expense. Output transformer tapped at 4, 8, and 16 ohms. Bass and treble tone controls provided on the front chassis apron.

MODEL A-7D  
**\$1695**  
 Shpg. Wt. 10 Lbs.



**3**

**HEATH  
 COMPANY**

A SUBSIDIARY OF DAYSTROM INC.

**BENTON HARBOR 20, MICHIGAN**

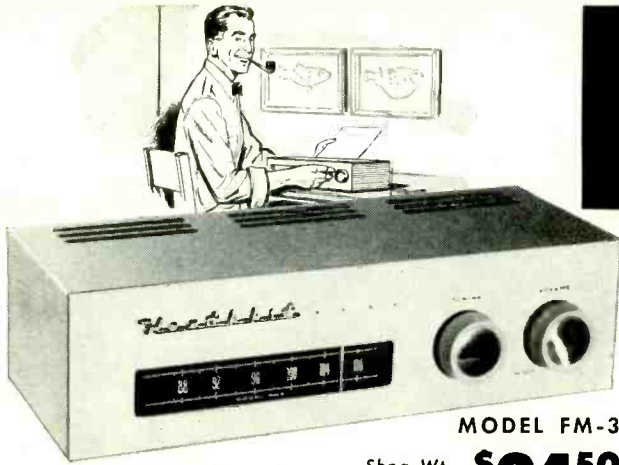

MODEL FM-3

Shpg. Wt. 7 lbs. **\$24.50**  
(with cabinet)

The new Heathkit Model FM-3 features tremendous circuit improvements and brand new physical design. Sensitivity is better than 10 uv. for 20 db of quieting, and it employs a completely modern tube line-up for high gain and stable operation. Incorporates its own power supply, and has provision for low-level or high-level output at low impedance.

The attractive Model FM-3 matches the WA-P2 Pre-amplifier in color, styling, and physical size.

Incorporates automatic gain control, a highly stabilized oscillator, and illuminated tuning dial. Educational treatment of construction manual simplifies assembly for the newcomer to electronics. IF and ratio transformers are pre-aligned, and the front-end tuning unit is pre-assembled and aligned. Uses 6BQ7A as a cascade type RF stage, 6U8 oscillator-mixer, two 6CB6's as IF amplifiers, a 6AL5 ratio detector, a 6C4 audio amplifier, and 6X4 rectifier.

*Brand New* HEATHKIT HIGH-FIDELITY **FM TUNER KIT**

Features

- ▶ Brand New, Modern FM Circuit Using Latest Type Miniature Tubes.
- ▶ Low-Noise Cascade RF Stage—Two IF's—Ratio Detector—Stage of Audio.
- ▶ Extremely Good Sensitivity and Band-Pass for Outstanding Performance.
- ▶ Strikingly Attractive Satin-Gold Finish to Match Heathkit Model WA-P2 Pre-amplifier.
- ▶ Compact Physical Dimensions for Most Pleasing Appearance and Increased Circuit Efficiency.

HEATHKIT BROADCAST-BAND **RECEIVER KIT**

Build your own radio receiver with confidence, even if you are a beginner. Complete instructions supplied.

Features transformer-type power supply, high-gain miniature tubes, built-in antenna, 5½" speaker, and planetary tuning from 550 Kc to 1500 Kc. Adaptable for use as AM Tuner and phono amplifier. Educational treatment of the construction manual helps the beginner learn about radio circuits and parts as he builds.

**CABINET:** Fabric covered plywood cabinet with aluminum panel as shown. Part 91-9, Shpg. Wt. 5 lbs., \$4.50.



MODEL BR-2  
**\$17.50** Less Cabinet  
Shpg. Wt. 10 lbs.

Are you on our mailing list? If not—how about sending us your name?



**ORDER BLANK**

from \_\_\_\_\_

\_\_\_\_\_

\_\_\_\_\_

- SHIP VIA
- Parcel Post
  - Express
  - Freight
  - Best Way

(PLEASE PRINT)

QUANTITY	ITEM	MODEL NO.	PRICE

NOTE: ALL PRICES SUBJECT TO CHANGE WITHOUT NOTICE.

Enclosed find ( ) check ( ) money order for \_\_\_\_\_ Please ship C.O.D. ( ) postage enclosed for \_\_\_\_\_ pounds.

On Express orders do not include transportation charges—they will be collected by the express agency at time of delivery.

ON PARCEL POST ORDERS include postage for weight shown. ORDERS FROM CANADA and APO's must include full remittance.

Kilovoltmeter made in plastic bottle cap.

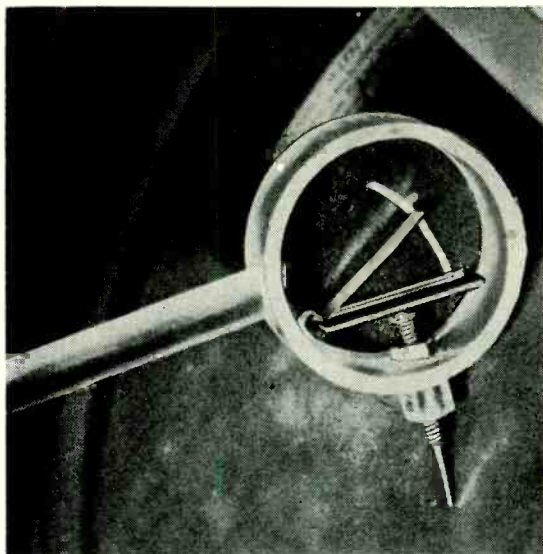

This kilovoltmeter is made from a plastic ring with transparent plastic covers. It is measuring voltage on metal TV tube.

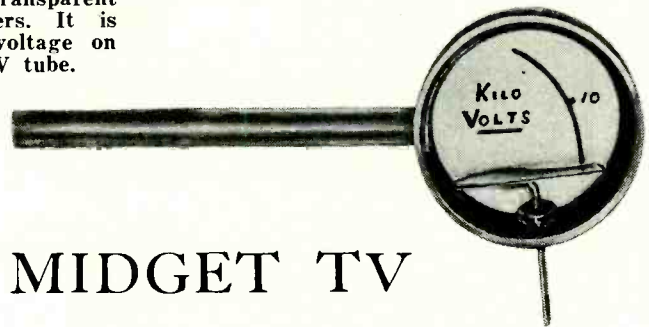

# MIDGET TV KILOVOLT METER

By ELLIOTT A. McCREADY

WHEN the complaint is "sound but no picture," the obvious thing to check is the high-voltage system of a television receiver. This is a relatively easy task in the shop. In the customer's home, with little test equipment available, the situation is altogether different. One widely used check for high voltage is to pull the high-voltage lead from the picture tube and note the arc when the lead is held a short distance from the second-anode connection. This check, while simple, leaves much to be desired. Not only is it hazardous and inaccurate, but usually next to impossible to perform on a metal picture tube. What is needed then is an accurate instrument that is much smaller than a v.t.v.m. and high-voltage probe.

The midget TV kilovoltmeter was inspired by a home-made electroscopes and pretty well fills the bill in so far as size, weight, ruggedness and accuracy are concerned. It can be constructed in an hour or so. The instrument operates on the electrostatic principle — a high voltage is applied to a metal plate and a piece of foil attached to one end of the plate is repelled. The distance that the foil is deflected varies as the applied voltage. As the electrostatic force acting on the foil is very small, the instrument will produce a readable indication only for voltages in the order of several thousand.

## Construction

A 1½ x ½-inch plastic or Bakelite medicine bottle cap is used as the case of the instrument. Two ¼-inch holes are drilled in the edge of the cap at a 90° interval. In one of these holes cement the handle of the instrument, a 3-inch length of ¼-inch polystyrene rod. In the other hole insert a ¼-inch length of ¼-inch polystyrene rod having a 1/16-inch hole through the center. Bend a ⅜-inch hook in a 1½-inch length of No. 16 tinned copper wire and insert the wire in the ¼-inch piece of polystyrene rod as shown in the diagram. With a small blowtorch, heat the ends of the

short polystyrene rod until the rod melts slightly and anchors itself to the case and the wire. Don't be tempted to cut corners and use cement to hold the wire in place or to hold the rod to the instrument case. Doing this will spoil the insulating qualities of the polystyrene. Solder a 1 x ¼-inch thin brass or copper plate to the hook in the wire inside the case as shown.

Cut a circular piece of white cardboard to fit inside the case, inscribe an arc on it and cement it to the inside of the instrument case. Cut a 1 1/16 x ¼-inch piece of very light metal foil, taper one end slightly, bend and clamp the tapered end around the left end of the metal plate. Make certain that the metal plate is clean at this point and that the foil is tightly clamped. Place a spot of service cement over the lower edge of the foil after it has been clamped to secure it to the metal plate. Adjust the foil so that, when the instrument is right side up, the foil just rests on the metal plate. Cut a celluloid disc the size of the case to form a face, but don't attach it yet.

Holding the instrument by the polystyrene handle, touch the projecting wire to the anode terminal of a television receiver known to be operating at approximately 10 kv. Note the position of the foil and mark the dial scale accordingly. My instrument is calibrated at only one point — 10 kv, as

voltages above and below this value can be estimated fairly accurately. Deflection is determined by foil thickness and the amount of taper at the end of the foil. The foil used in my instrument was obtained from a chewing-gum wrapper and tapered to give a 10-kv indication about midway on the scale. Polystyrene *must* be used as an insulating bead or the instrument will not function properly. After calibration is completed, cement the celluloid face to the instrument case.

An advantage of this little gadget is that it isn't necessary to touch the probe wire to a bare high-voltage point. There is enough leakage in most of the insulating materials used to give good foil deflection by just touching the probe to the insulated high-voltage lead or metal picture-tube sleeve. Thus, the presence of high voltage in the anode lead of the picture tube can be determined without removing the lead from the picture tube. After use, the foil is collapsed by touching the case and probe of the instrument with the hand. A modified fuse clip attached to the side of the service kit will hold the instrument in an upright position while not in use. Repeated jarring while inverted tends to bend the foil away from the metal plate.

Two things are very important in the construction of this instrument — use polystyrene to insulate the wire probe from the case; be sure the foil strip makes good contact at the end of the metal plate.

Since this instrument operates on the principle of electrostatic repulsion between the foil and the plate, it is very possible that under conditions of high humidity the meter will read low as a result of leakage. The only protection against this is for the technician to familiarize himself with his instrument and observe its operation in humid weather. Humidity should not be too great a problem since the inside of a TV cabinet is usually fairly warm and dry if the set has been operating for several minutes.

END

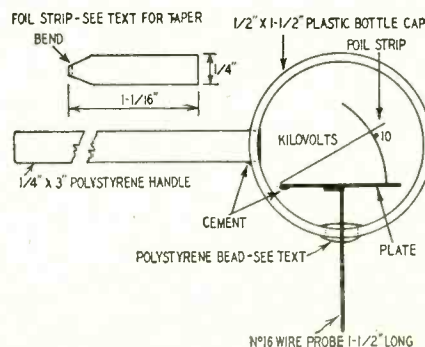

Construction of the TV kilovoltmeter.

# R-C CONTROLLED OSCILLATOR

Front view of R-C controlled oscillator

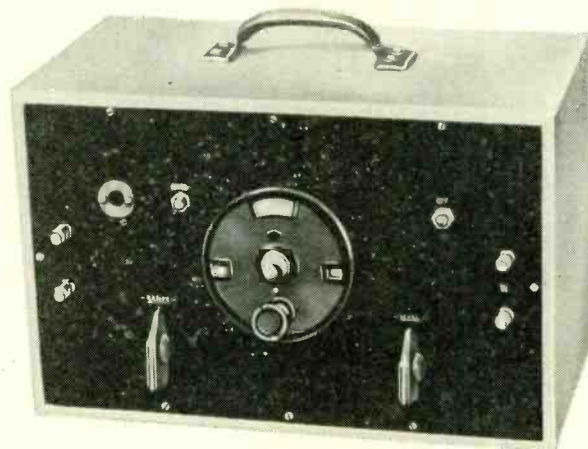

*Easily constructed and calibrated, instrument provides highly stable sine-wave output*

By JOHN W. STRAEDE

**A**UDIO-FREQUENCY oscillators have a number of uses, the most obvious being the measurement of amplifier frequency response, loudspeaker testing and signal tracing.

When an amplifier is being built, it is very desirable to have a variable-frequency oscillator for finding the resonant frequencies of microphone, pickup, coupling transformers and loudspeaker. It is important that the resonant frequencies of these components do not occur too close together.

Three main types of a.f. oscillators are used to produce sine waves.

There is the "direct L-C" type wherein an oscillatory circuit (consisting of an inductance and capacitor in parallel) are connected to an amplifier, part of the output being returned to the oscillatory circuit to maintain oscillation. This simple type of oscillator is reliable but has a marked disadvantage: it is not easy to obtain a wide frequency range because low frequencies demand

huge values of inductance and capacitance. Such a circuit is good where a small output at one fixed frequency is required; a suitable circuit is shown in Fig. 1.

To obtain a wide range of frequencies, the rectification of the "beats" from a pair of high-frequency oscillators can provide a signal, the frequency of which is the difference between the high-frequency oscillators. A block diagram of such an arrangement (called a beat-frequency oscillator) is shown in Fig. 2. Beat-frequency oscillators, though widely used, are not too suitable for the home constructor because very careful layout and shielding are necessary.

To produce a "straight-out" oscillator, attempts have been made to use combinations of resistance and capacitance as the frequency-controlling device. An example of such a circuit is the multi-vibrator which, however, suffers from exceedingly poor waveform (poor because rich in harmonics).

Other examples are the Nichols (Fig. 3) and van der Pol (Fig. 4) oscillators. The Nichols uses a three-stage phase-shifting network with a single high-gain tube. In the van der Pol the single tube is replaced by three—inserted between the sections of the resistance-capacitance network.

### The Willans circuit

This arrangement consists of a two-stage amplifier (so that input and output are in phase) together with a resistance-capacitance network very similar to that used in two arms of a Wein bridge. The network consists of two capacitors equal in value connected together, and two resistors of equal value. Resistor R1 is in series with C1, and R2 is in parallel with C2 (Fig. 5).

The Willans circuit has several advantages over a beat-frequency oscillator: the range is easily divided, permitting rapid frequency changing and ease of adjustment; the same calibration marks can be used on each range if good components are used and care is taken with the construction; the oscillator is very free from drift—no zero-set device is required; the oscillator can be synchronized for the generation of multiple and submultiple audio frequencies. This last advantage makes the oscillator very suitable for demonstrating Lissajous figures.

Because the frequency is inversely proportional to capacitance (not to its square root as in tuned oscillators), a large frequency ratio can be covered with one sweep of the tuning dial. At low capacitances, however, stray interelement and interlead capacitances become troublesome, so each range is limited at its high-frequency end by providing a fixed capacitor in parallel

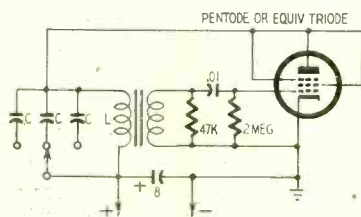

Fig. 1—An audio-frequency oscillator.

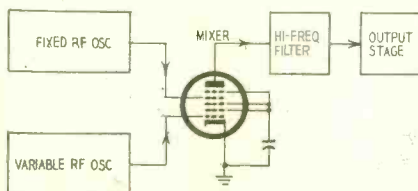

Fig. 2—The beat-frequency principle.

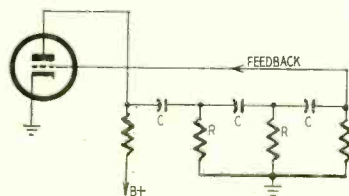

Fig. 3—Diagram of Nichols oscillator.

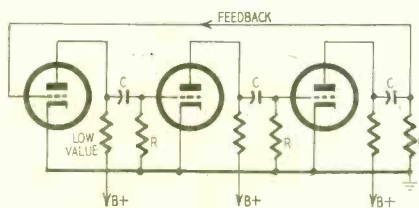

Fig. 4—Van der Pol oscillator circuit.



# WIRE AND CABLE FOR EVERY ELECTRONIC PRODUCT



TV STUDIO  
CABLE

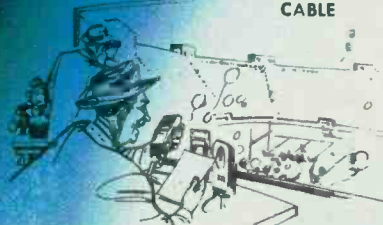

MICROPHONE CABLE

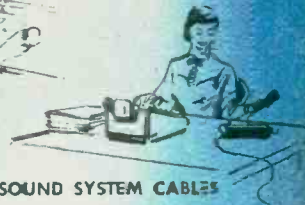

SOUND SYSTEM CABLES

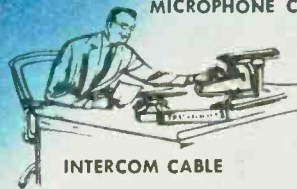

INTERCOM CABLE



MAGNET WIRE—HOOK-UP WIRE



BROADCAST AUDIO CABLES

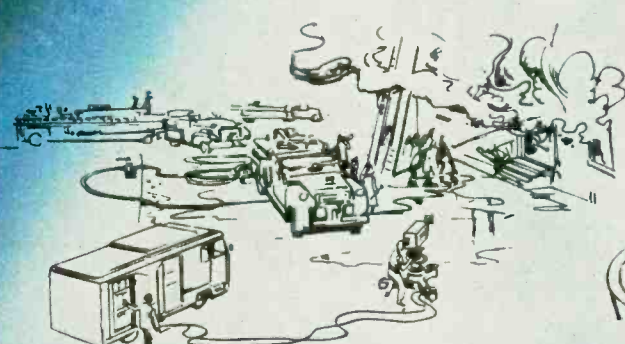

TV CAMERA CABLE

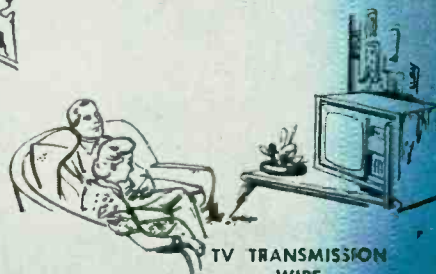

TV TRANSMISSION  
WIRE

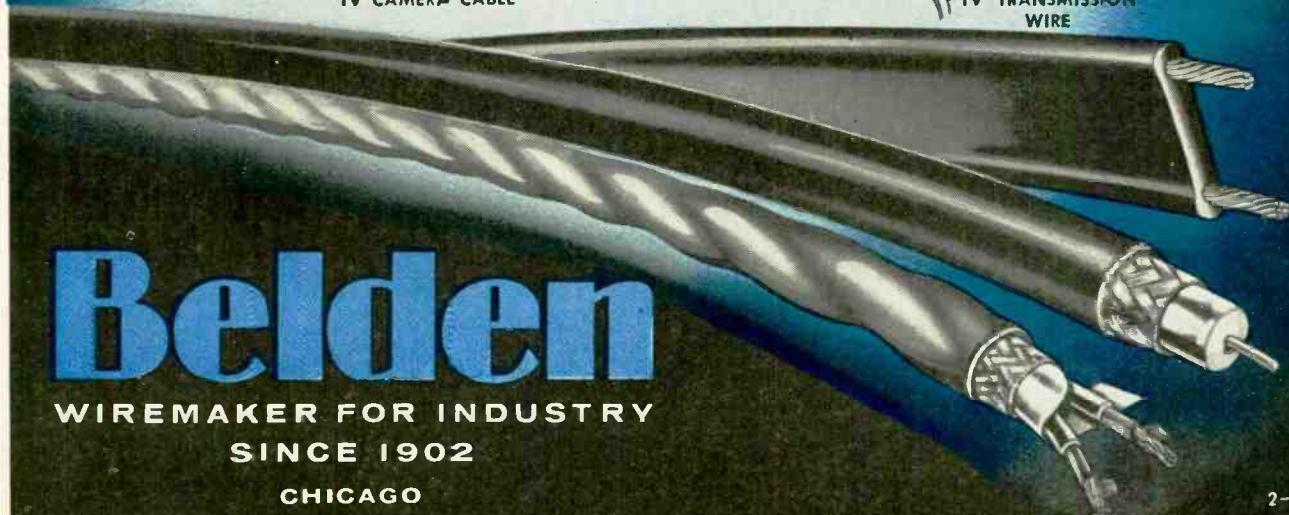

# Belden

WIREFORMER FOR INDUSTRY  
SINCE 1902  
CHICAGO

## TEST INSTRUMENTS

with each tuning capacitor (Fig. 6). One of the fixed capacitors is 150  $\mu\text{f}$ , the other is made up of a trimmer in parallel with a 100- $\mu\text{f}$  capacitor.

With a standard four-gang variable capacitor, the frequency ratio is approximately 1 to 5 for the ends of each range. The ranges can be changed by switching resistors in or out of the circuit.

The low-frequency limit is set by the maximum permissible resistance in the grid circuit of the first tube; the upper limit by the reduction in gain of the second tube when the resistances are too low.

Good waveform is obtained by running each tube well within its limits. Negative feedback is used over the output stage and over the two-stage amplifier in the Willans circuit. Because the two-stage amplifier requires a gain of only 3, plenty of feedback can be used.

The waveform is best when the positive feedback via the Willans circuit just produces oscillation. Two automatic devices are used to insure this:

First, there is automatic volume control, obtained by rectifying part of the output from the second tube and using it for bias. This second tube has a fairly remote cutoff and the variation in bias does not cause as much distortion as an overload would.

Second, the negative feedback circuit consists of a voltage divider, part of which is a 470,000-ohm carbon resistor; the other part is a metal filament lamp. Carbon behaves in an opposite manner to metal when it is heated. If the output from the second tube increases,

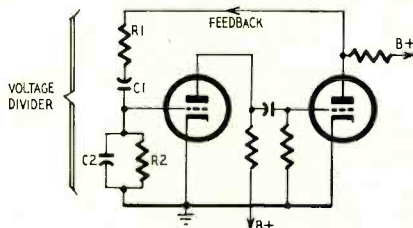

Fig. 5—Schematic of Willans circuit.

more a.c. flows through these resistors and they are heated. The carbon resistor decreases in value while the other rises, thereby giving increased negative feedback and reduced gain.

(Mr. Straede is in Australia and some tubes readily available to him might be difficult for some of us to find. Such is the case with the 6B8-G. If one is not available, you can substitute a 12C8 and 12-volt equivalents of the other tubes along with a transformer with a 12-volt or two 6-volt windings.

Also, you can stick to 6-volt types and substitute a 6SF7 or 6SV7 or even any standard r.f. amplifier pentode and a 1N34 or similar germanium rectifier. When substituting any type other than a 12C8, you will probably have to experiment with the values of the screen, bias and a.v.c. resistors.

Lamp LM is a 230-volt 10-watt unit—G-E 10S6/10 or equivalent—available from many large lamp distributors. If this lamp cannot be located, the constructor may use a 2.5-watt 115-volt unit. This may change the time constant of the feedback circuit and necessitate experimenting with the values of the other components in this circuit.—*Editor*)

If desired, the circuit can be simplified by omitting the a.v.c. and using grid-leak bias for the second tube—grid-leak bias gives a small amount of automatic control because the bias voltage is approximately equal to the peak value of the signal voltage and the gain drops once the bias passes a low voltage.

The waveform is also improved by fitting a shunt capacitor across the output—this removes only the higher harmonics and is of a different value on each range.

### The oscillator circuit

Fig. 6 shows the complete circuit. The four tubes are standard types, the Willans amplifier using a 6J7-G and a 6B8-G (single-ended GT types are O.K.), the output (and buffer) stage a 6V6-GT and the rectifier a 6X5-GT.

The 6V6-GT output tube is connected

as a triode (to reduce effects of varying output load) and fitted with a permanent load consisting of a 39,000-ohm 1-watt resistor.

Bias for the output stage is from the usual cathode resistor shunted by two capacitors, one a 100- $\mu\text{f}$  25-volt electrolytic, the other a 0.1- $\mu\text{f}$  paper unit.

Best waveform can be obtained with the regeneration control which can be either in the form of an adjustable volume control as shown in the diagram or another bank on the range control can provide separate adjustments on each range. If the apparatus is carefully constructed and the resistors are accurate, this regeneration control is unnecessary.

The four-gang capacitor (used as a two-gang 730- $\mu\text{f}$  unit), must be very carefully insulated from the chassis as well as from the dial—some flexible couplings are good insulators; others are not.

### Construction and adjustment

Contrary to expectations, extreme shielding was not found to be necessary. The tubes are shielded and the power transformer and rectifier are as far as possible from V1 and the R-C network.

A 12 x 6 x 2-inch chassis was used with a front panel of crackle-painted Masonite 14 x 9½ inches. Layout details are shown in Fig. 7.

When wiring, filament leads must be kept well away from grid and anode leads or waveform and frequency may go a little "haywire" around the power-

### Parts list for R-C oscillator

**Resistors:** 1—150, 1—1,000, 1—39,000, 1—47,000, 2—100,000, 1—150,000, 3—270,000, 1—470,000 ohms, ½ watt; 2—1, 1—1.5, 2—3.3 megohms, ½ watt; 2—1,000 ohms, 3 watts; 2—39,000, 2—180,000, 2—390,000 ohms, 2—2, 2—10 megohms, ½ watt, 1%; 1—500,000 ohms, 1—1 megohm, potentiometers.

**Capacitors:** 1—100, 1—150  $\mu\text{f}$ ; 1—.001, 1—.003, 1—.005, 1—.01, 1—.02, 1—.05, 2—.01, 2—.025, 4—.05, 1—1  $\mu\text{f}$ ; 1—50  $\mu\text{f}$ , trimmer; 1—4-gang variable, 365  $\mu\text{f}$  per unit.

**Electrolytics:** 1—20-20  $\mu\text{f}$ , 350 volts; 1—10-10  $\mu\text{f}$ , 450 volts; 1—100  $\mu\text{f}$ , 25 volts.

**Miscellaneous:** 1—lamp LM (see text); 1—power transformer, 700 volts c.t. @ 40 ma, 6.3 volts @ 2 amps; 1—6J7-G, 1—6B8-G, 1—6V6-GT, 1—6X5-GT; 4—octal sockets; 1—output transformer, 10,000-ohm primary to 4-ohm secondary; 1—chassis; 1—3-gang 5-position rotary switch; 1—line cord; 2—jacks.

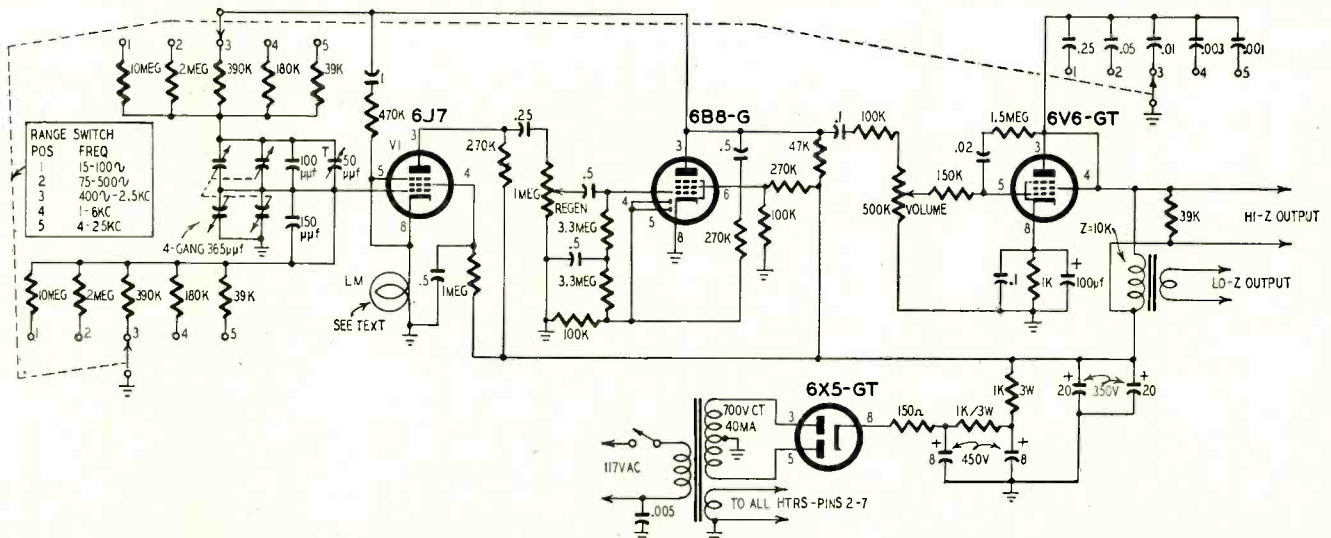
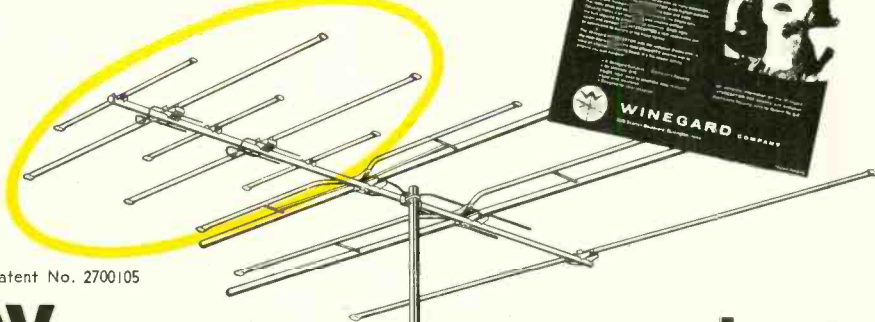

Fig. 6—Schematic of the resistance-capacitance controlled oscillator.

# Remember This?

Nearly two years ago, Winegard introduced its now famous Electro-Lens Focusing\* — the world's first antenna director system that works simultaneously and efficiently on both high and low TV bands. The ad at right, first published early in 1954, explained the exclusive, revolutionary Electro-Lens\* principle. This ad served as forerunner of a feature that has since been imitated by almost every manufacturer in the industry.



\*Patent No. 2700105

# Now! EVERYBODY wants to get into the act!

Today, there are more TV antennas on the market patterned after the original Winegard Interceptor than there are clowns in a circus. But the Winegard Interceptor is still the star performer . . . the leader . . . and the world's most imitated TV antenna. Sales have skyrocketed because, by every means of comparison, Winegard Interceptors set the pace. Compare performance and construction . . . compare appearance . . . compare ease of assembly and installation. Winegard Company introduced and perfected Electro-Lens focusing . . . the first all-channel Yagi . . . Hairpin Tuning (often called the bazooka) . . . Multi-Resonant Driven Elements . . . colorful Anodizing. And . . . Winegard Company will continue to originate and introduce new engineering triumphs . . . and invite comparison! Today, tomorrow . . . as in the past . . . Winegard will be stealing the show wherever you go!



## Today WINEGARD Interceptor TV Antennas are Even Greater . . . with Colorful Anodizing!

Color is here to stay! And since Winegard believes in giving people what they want, Winegard Anodized Interceptors are becoming more popular day by day! Brilliant shades of gold, green, red and blue to select from . . . longer antenna life from protective anodizing. Winegard has again

pioneered an achievement destined to set a pattern for neat, glamorous appearance . . . and enviable performance. See Your Jobber or Write For Further Information to **WINEGARD COMPANY, Burlington, Iowa.**

You can always depend on Originals by **WINEGARD**

# 3

more new  
\*correct  
replacement  
flybacks  
(Horizontal Output Transformers)

by **TRIAD**

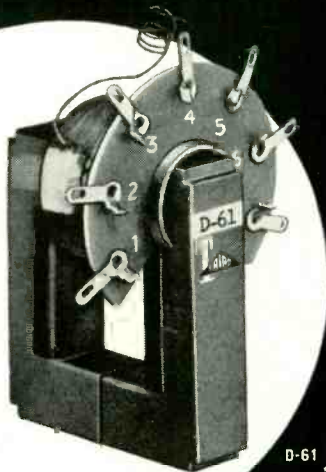

**TRIAD**  
D-61 Sylvania  
\*Correct  
Replacement

D-61 List Price \$7.25 correct replacement for Sylvania Part 241-0003

D-62 List Price \$7.75 correct replacement for Sylvania Part 241-0005, 241-0006

D-63 List Price \$8.20 correct replacement for Sylvania Part 241-0007

TRIAD \*Correct Replacement flybacks are mechanically and electrically correct ruggedized versions of manufacturer's items — and wherever possible **COMPOSITE REPLACEMENT** to fill a number of requirements where mechanical and electrical specifications are identical.

All items are listed in Sams Photofact Folders and Counter Facts.

Write for catalog TV—155B



4055 Redwood Ave. • Venice, Calif.



## TEST INSTRUMENTS

line frequency and its harmonics. One side of the filament circuit is grounded.

When completed, connect the oscillator to a loudspeaker (any impedance will do), with preferably an oscilloscope in parallel. The gain control in the Willans circuit and the volume control are both tuned "flat out." Next the gain (or regeneration) control is turned down until oscillation ceases at each end of the range for the same setting of the control. If it is found that oscillation ceases on one range for a higher setting of the control, it means that the two resistors for that range are unequal

range can usually be cured by replacing the 1- $\mu$ f capacitor in the feedback line with one of lower value, say 0.5  $\mu$ f. A low-value coupling capacitor between the first two tubes is also a source of trouble.

Calibration is best done by Lissajous figures on a cathode-ray oscilloscope, using a 50- or 60-cycle supply as the standard. Alternatively, the points for the line frequency can be found by using a loudspeaker and a filament transformer. The secondary of the filament transformer is connected in series with the high-impedance output

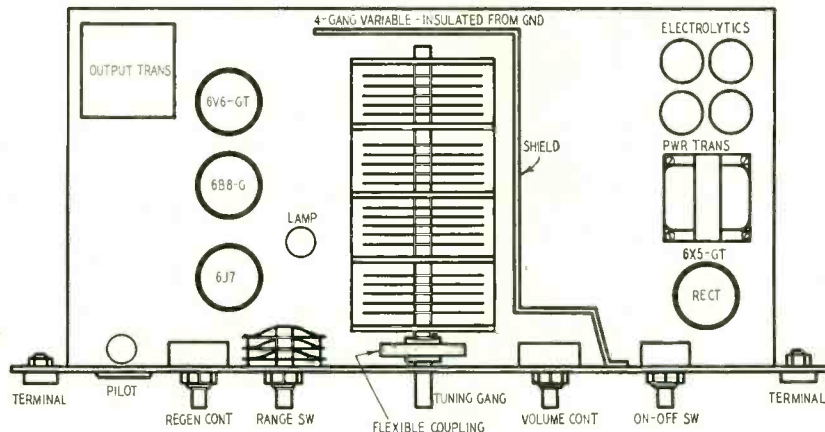

Fig. 7—Layout of the controlled resistance capacitance audio oscillator.

and that the upper resistor (upper on the circuit diagram) is larger than the lower. Each of the 10 resistors should be within 2%, preferably closer.

If despite the resistors being equal in value the highest frequency range is apt to cease oscillation or fails to oscillate, some high-frequency compensation can be introduced in the negative feedback circuit by connecting a small capacitor (say .002  $\mu$ f) across the cathode lamp resistor. Alternatively, the screen grid of the second tube can be bypassed with a small capacitor to obtain the same effect.

Failure to oscillate on the lowest

and a speaker. The oscillator is adjusted until beats are heard (on the lowest frequency range), and the tuning control is adjusted until the beats cease. Now one point is fixed. Borrow a piano! Find the corresponding key on the piano and each octave of this key gives double the frequency. Each single note above this key increases the frequency in the ratio  $^{12}\sqrt{2}$  (the twelfth root of 2). Frequencies can be compared to within a fraction of a cycle per second by ear, by listening to the beats—one beat per second corresponding to a frequency difference of exactly one cycle per second.

END



Suggested by: Bob Loynd, Waltham, Mass.

"Damn these sets on wheels!"



# SYLVANIA SILVER SCREEN 85

## No. 1 in independent survey among servicemen



"Fewer returns" votes for "Silver Screen 85" were more than twice that of No. 2 and No. 3 brands combined

### Best quality and consumer demand important reasons why servicemen make "Silver Screen 85" their No. 1 choice.

Servicemen gave "Silver Screen 85" the highest vote of confidence paid any picture tube in a national survey recently conducted by an independent research corporation. "Silver Screen 85" took top honors in answer to the key question, "what picture tube do you consider *best regardless of price?*"

#### FEWER RETURNS

"Fewer returns" were experienced with "Silver Screen 85" than with the No. 2 and No. 3 brands combined. "Best quality" and "better picture" were highest among reasons servicemen gave for voting "Silver Screen 85" No. 1.

#### PUBLIC DEMAND

Consumer demand was one of the factors of importance servicemen credited to "Silver Screen 85" according to the survey. When asked why they specified brand to their distributors, more servicemen named public demand as their reason for "Silver Screen 85" preference.

In fact, among the top four reasons why servicemen specified brand, "Silver Screen 85" again took 1st place.

You, like the servicemen who offer its high praise, can profit from "Silver Screen 85's" success story. Make "Silver Screen 85" your good-will leader. Feature it; promote it; you'll develop strong customer relations and high word-of-mouth recommendations. Your business will flourish and so will profits.



# SYLVANIA®

SYLVANIA ELECTRIC PRODUCTS INC.  
1740 Broadway, New York 19, N. Y.  
In Canada: Sylvania Electric (Canada) Ltd.,  
University Tower Bldg., Montreal

# A 1,000 - and 100 - cycle FILTER

*Simple device can be used for alignment and measurement*

By JAMES FRED

SOME months ago I was employed in the engineering department of a private-brand radio manufacturer. The company decided to go into production on a u.h.f. converter, and one of the pieces of test equipment needed was an audio-frequency vacuum-tube voltmeter with a 1,000-cycle filter. We developed our own vacuum-tube voltmeter and intended to use a commercial 1,000-cycle filter. But when we placed our order, we were told delivery would begin some 8 months later. The price was \$25 each. Since we needed about 15 filters we decided to make our own.

Fig. 1 shows the overall response curve (solid line) we ran of the commercial model; the dashed line shows the response curve of the model we decided to build. Both curves were made from the readings on an audio vacuum-tube voltmeter. We fed the filter various frequencies from 500 to 1,500 cycles at constant amplitude and read the output voltage on the v.t.v.m. We tried to duplicate the performance curve of the commercial model but had to compromise somewhat in the interest of cost and availability of parts.

The inductance that gave us the best performance was a 4.5-henry, 80-ohm (d.c. resistance), 250-ma filter choke. This was used in the final model with a .003- $\mu$ f capacitor for a 1-kc filter.

The signal generators in most radio laboratories use 1-kc modulation, while

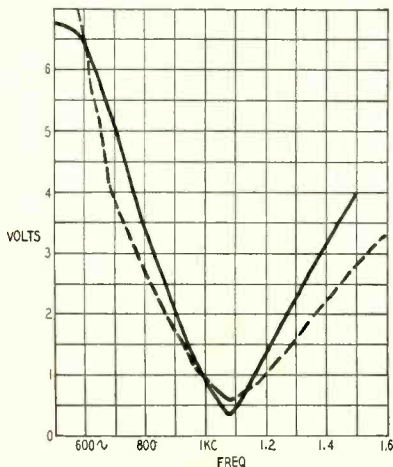
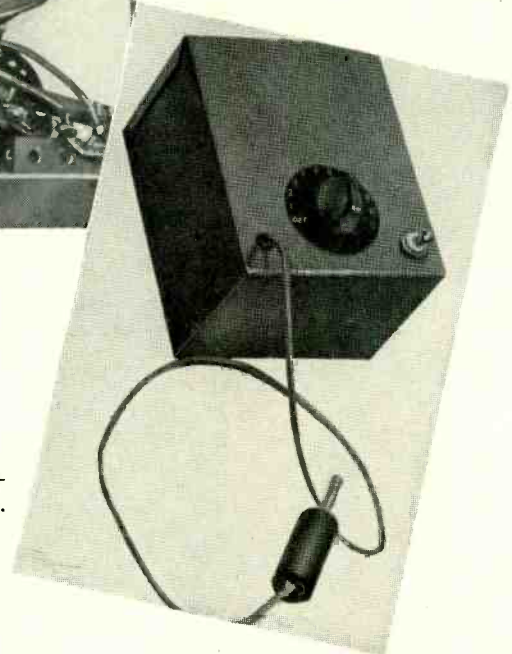

Fig. 1—Frequency response of filters.



An underchassis view of the filter.



Top view shows filter chassis and plug.

most technicians have generators with 400-cycle modulation. This is why we describe the design for a combination 1,000- and 400-cycle filter.

Fig. 2 shows a schematic of the filter. When purchasing the filter choke be sure you get the unit called for (Stancor C1411). The selector switch, a Mallory 153L, is a special type used in capacitor decade boxes. With this switch and four

capacitors you can put the capacitors in parallel and get 10 different combinations. With .001-, .002-, .003- and .004- $\mu$ f capacitors, you can get combinations from .001 to .01  $\mu$ f in steps of .001  $\mu$ f. The switch and capacitors permit you to adjust the frequency of your filter  $\pm 10\%$ . This is necessary because of the tolerance of the filter choke and the fact that all signal generators do not have exact frequencies but may vary  $\pm 5\%$ . We can peak the filter to the desired frequency by turning the selector switch. Switch S2 is a s.p.d.t. unit for selecting either 400 or 1,000 cycles.

A Mallory type 75 plug and shielded wire connect the filter into the circuit. The components are housed in an aluminum box 3 x 4 x 5 inches. Fig. 3 is the wiring diagram of S1. Rubber grommets are used to bring the shielded wire through.

### Using the filter

You will need an audio or a.c. vacuum-tube voltmeter. Many voltmeters of this type have a suitable jack. If yours doesn't, a jack must be installed. We put a jack in a Heathkit v.t.v.m. and it worked very well. The only additional parts needed are a .002- $\mu$ f capacitor and a jack suitable for the

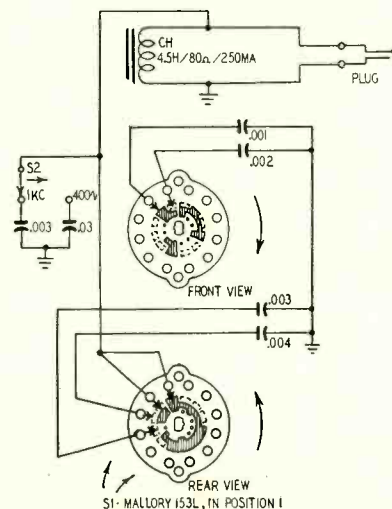

Fig. 2—Schematic diagram of filter.

## TEST INSTRUMENTS

plug. Fig. 4 shows the jack and .002- $\mu$ f capacitor located between the 6AV6 and 6AT6. When the filter is plugged into the voltmeter, the meter no longer reads the voltages indicated on the scale, but a lower amount. This doesn't affect its use for alignment purposes because we are interested in relative amounts only. We will still be able to measure increases and decreases in signal strength. Removing the plug from the v.t.v.m. jack restores normal operation.

If you have a signal generator, con-

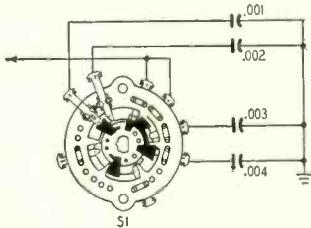

Fig. 3—Wiring diagram for switch S1.

nect it to the v.t.v.m. and set the generator to 1,000 cycles. Adjust the output to half-scale reading. As you tune the generator to either side of 1,000 cycles, the meter should read a constant amount. Now plug in the filter set at

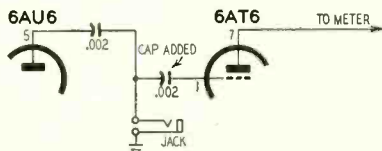

Fig. 4—Modifying v.t.v.m. for filter.

1,000 cycles. As you tune the generator on either side of 1 kc, the meter reading will drop off. This shows that the filter is working properly. You can check

the 400-cycle filter by the same method.

When making r.f. measurements on receivers, u.h.f. converters or TV sets, an audio filter should be used. The output of the signal generator, modulated at 1 kc, is connected to a u.h.f. converter. The output of the converter goes to a diode probe which removes the r.f. carrier and gives us the 1,000-cycle audio signal. This goes into an audio-frequency vacuum-tube voltmeter where the amplitude is indicated on the meter. The u.h.f. converter would also pick up electrical noise, automobile ignition and all sorts of man-made static. This, too, would cause a meter indication and give false information. By inserting a 1-kc filter in the a.f. v.t.v.m. we can bypass all other frequencies to ground. This will let only the 1,000-cycle modulation come through, giving a very accurate measurement of the sensitivity of the converter.

When checking receiver gain and

### Parts list for filter

**Capacitors:** 1—.001  $\mu$ f, 1—.002  $\mu$ f, 1—.003  $\mu$ f, 1—.004  $\mu$ f; 1—.003  $\mu$ f, 1—.03  $\mu$ f, silver mica 5% (if unavailable in these values, parallel smaller units); 1—.002  $\mu$ f (for meter).

**Miscellaneous:** 1—phone plug and jack; 1—choke, 4.5 h (Stancor C1411 or equivalent); 1—s.p.d.t. switch; 1—decade type switch (Mallory 153L); 1—chassis.

alignment, we feed a signal into the radio receiver, detect it with a diode probe and feed the audio into the v.t.v.m. As before, we use the filter to get rid of unwanted electrical noises and static. We can align the i.f. and r.f. stages much more easily and accurately using this equipment. Since this is done in radio factories, service technicians would be wise to follow the same procedure. END

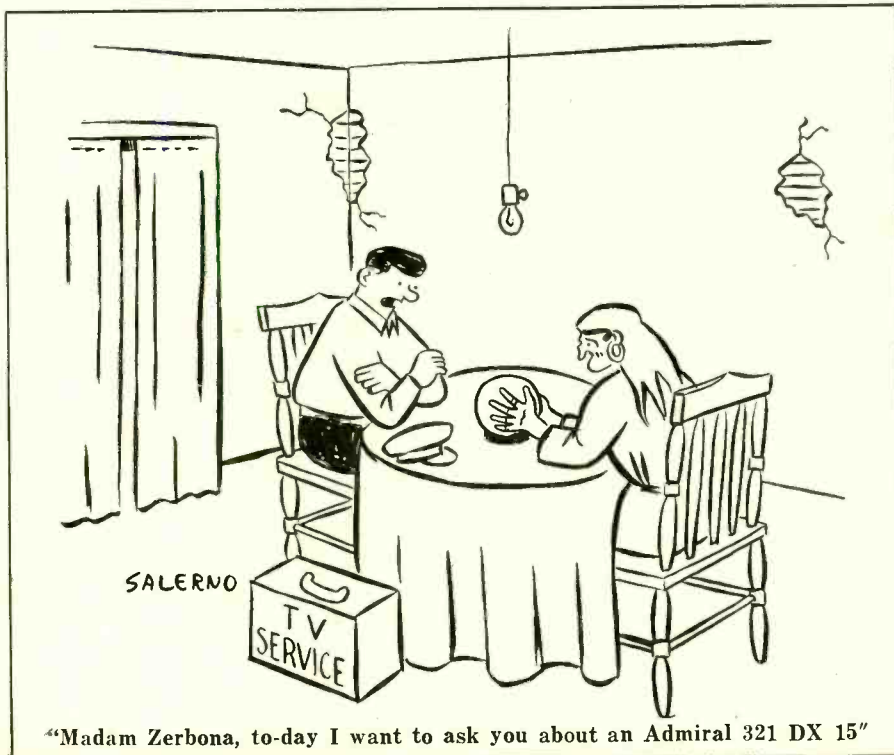

ARE ANY  
OF THESE  
YOUR CUSTOMERS?

I have a speaker  
I'd like to keep.

I want to start  
a simple system  
and build on it.

I'd like to start  
from scratch.

I have a system  
I'd like to improve.

You can solve **all**  
their problems with **P•S•E**

**P•S•E** (University's Progressive Speaker Expansion plan) is the most revolutionary concept in speaker history. It's the best salesman you could possibly have. It makes selling your customers *easy* and *profitable*.

Here's how it works: University speaker components, enclosures and networks have been so uniquely designed that it is possible to start an excellent basic system, *at low cost*, and add to it later—while enjoying immediate listening satisfaction.

**P•S•E** makes it possible to build up to a great variety of magnificent sounding systems, most of which are not available competitively or commercially. Systems can be built in successive, inexpensive stages regardless of budget or space limitations.

Think of the sales angle! Now you can sell a speaker and assure your customer that *it will never become obsolete*. Now you can also improve his present speaker or system *without discarding what he has*.

The beauty of it all is that the first sale is not the last. He keeps coming back for more . . . and when you've completed his system, *he sends his friends*.

Simplified, easy to follow instructions called **TECHINIGRAMS** are available **FREE**. Fill out and mail coupon immediately for further information.



**University**

**LOUDSPEAKERS, INC.** Desk B-5

80 South Kensico Avenue, White Plains, N.Y.

Please send me details showing how P•S•E can boost my profits immediately.

NAME \_\_\_\_\_

ADDRESS \_\_\_\_\_

CITY \_\_\_\_\_ STATE \_\_\_\_\_

# SERVICE INSURANCE THAT WORKS!

By RALPH W. HALLOWS

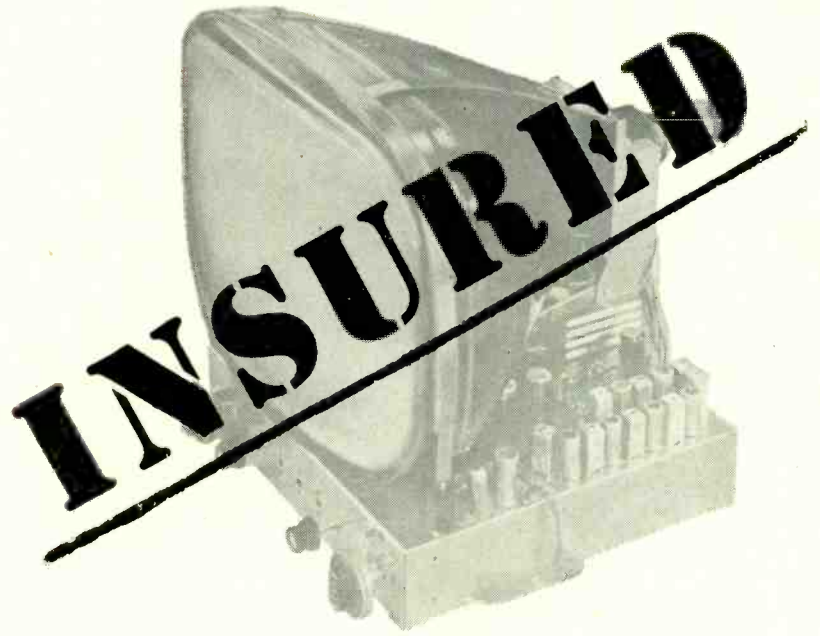

FULL maintenance insurance systems for TV receiving sets have been operating successfully here in Britain for some time now. It is not surprising that there should have been a wide demand for reliable all-in TV insurance. The cost of obtaining a 17-inch set and its antenna represents 10-12 weeks' earnings for the average working man. C-R tubes are very costly here and the 6-months' guarantee given on them by the makers does not cover labor charges for removing the old tube and fitting in a new one. Outside the guarantee period, the replacement of a C-R tube may cost those unfortunate enough to require it the equivalent of 3-4 weeks' earnings.

TV dealers soon found themselves up against hard cases in plenty, particularly among those customers who were buying their sets by installment payments. When an expensive replacement or repair was needed, these people were often sunk: they couldn't find the money to cover it in addition to their regular payments.

The effect on sales was serious. Many who intended to buy were deterred by the tales they heard from their friends of the unpleasant financial surprises that might come their way if they were unlucky with their TV receivers.

Some dealers started insurance schemes of their own. Since they hadn't sufficient data to go on, only a few of these worked well. Eventually the question of TV full-maintenance insurance was tackled by a federation to which a large proportion of the dealers in Britain belong. This is the Radio and Television Retailers Association, better known as the RTRA.

Having collected and compared average maintenance costs from dealers all over the country, the RTRA started its own insurance scheme. But business increased so rapidly that it was soon far

too big for the association's staff to tackle. It was therefore decided to launch a separate concern, managing its own affairs and its own finances, but closely linked with the RTRA.

This is Telesurance Ltd., one of the soundest and most successful maintenance insurance concerns in Britain. There are other reputable companies which operate on much the same lines, but since I am most familiar with the methods of Telesurance and since it is a system which might well appeal to American TV dealers, I'm going to confine myself to giving a brief account of the way it operates.

The root of the whole scheme is that the agents for its policies are dealers who are members of the RTRA. They collect the premiums, forwarding them to the central office, which issues the policies to viewers. If a TV repair or replacement is required by a policy holder, Telesurance authorizes the dealer concerned to carry it out and pays him the agreed rate for materials supplied and for work done.

In other words, both the dealer and his customer know exactly where they stand. The customer knows that in return for his annual (or monthly) premium any replacement or repair needed will be carried out at no further cost to him. The dealers know that he will be adequately and promptly paid for whatever he has to do. Sales resistance readily breaks down when the dealer is able to assure his customer that he can know to a penny what his viewing is going to cost in any year: the amount of the insurance premium *plus* the £3 (\$8.40) for his receiving license *plus* the trifling cost of power from the electric mains.

Now let's see what sort of premium the insured person has to pay and what it covers. The most popular screen size with us today is 17 inches. Larger mod-

els are available, but the 17-inch set is best adapted to the rather small living rooms of the present-day home.

If you take out a Telesurance policy when you install a new 17-inch set, you can make your choice of two alternatives. By paying £10.0.0d (\$28) a year or 19s.6d (\$2.70) a month you have these guarantees under a "B" policy:

1. The complete cost of all maintenance, repairs and replacements, including the C-R tube.
2. Full insurance against the theft of your set or against damage to it by fire or accident.
3. Indemnity up to £10,000 (\$28,000) for damage caused by the collapse of your antenna.

Alternatively, you can, if you wish, take out the "A" policy. For a set with a 17-inch tube this costs £16 (\$46.20) a year or £1.11.6 (\$4.40) monthly. In addition to the coverage already mentioned, this provides free replacement of the C-R tube, even if it is still in good condition, at the end of three years. Or, should you then prefer to go in for a new receiver, the full value of the C-R tube will be deducted from its cost.

The "A" policy can be taken out only for a new set. You can start a "B" insurance at any time up to two years after installing a set, provided that an accredited dealer certifies that it is in good working condition. There is naturally an increase in the amount of the premiums according to the age of the set. Thus, if a "B" policy is first taken out for a set that has been in use six months, the premium is £11.15 (\$32.90) annually, or £1.2s.9d (\$3.19) monthly. Should the set be a year old when the policy is issued, the yearly premium is £13.15 (\$38.50) or £1.6.3 (\$3.70) by monthly payments.

Well, there's the scheme. Viewers like it; dealers like it and, let me assure you, IT WORKS. END



**AGAIN  
IN '55**

**ALLIANCE GIVES YOU...**

**biggest, longest  
TV SPOT  
CAMPAIGN**

**30,000,000  
TV VIEWERS**  
*week after week*

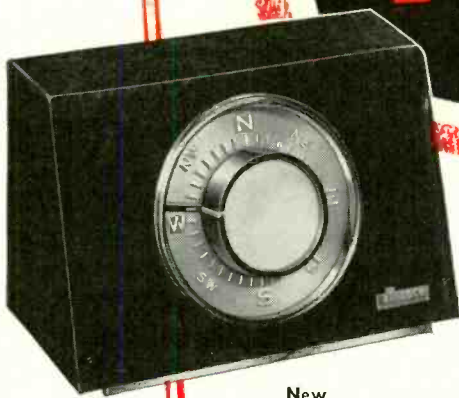

New

**MODEL U-98**—fully automatic—incorporates 32 distinct improvements—eliminates all arcing and consequent picture distortion—points directly, positively, instantly to target station—"just set it and forget it" . . . List Price, **\$39.95**

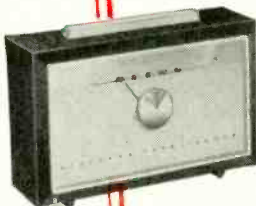

New

**MODEL T-12**—fingertip electrical operation. Rocker switch on top controls turning. Has direction indicator dial. Compact and smartly styled. Highly accurate! . . . List Price, **\$29.95**

When you sell Alliance Tenna-Rotor, you sell the pace-setter—the favorite for seven *solid* years!

30,000,000 folks see Alliance TV spots week after week . . . newspapers and magazines run hard-hitting Alliance ads all over the country . . . that's promotion—**sends sales your way!**

Alliance is sold the most, because it's seen the most. You profit most, coast-to-coast, with Alliance.

**Don't be misled!** Sell the acknowledged best-seller, best-money-maker . . . Alliance Tenna-Rotor!

**IMPORTANT!** COLOR is coming! Alliance Tenna-Rotor is the No. 1 TV accessory needed for sensitive color reception.

**Nearly 2,000,000 Alliance Tenna-Rotors are in use.**

**THE ALLIANCE MANUFACTURING CO., INC.**  
Alliance, Ohio

# Post-Acceleration Tube

By FRED SHUNAMAN  
MANAGING EDITOR

**A** NEW color TV picture tube that may have advantages over both the now almost universal shadow-mask type and its only present rival, the one-gun Lawrence tube, is in the developmental stage. Samples were demonstrated by the General Electric Co., at Electronics Park near Syracuse, N. Y., in late September. Problems of mass production are still to be straightened out but the company believes the tube may be on the market in about a year.

The new tube has three guns—arranged horizontally in a straight line (Fig. 1) rather than in a triangle—and a vertical grid or grille set in a rigid frame near the screen. The grille looks something like the grid of the Lawrence tube—though in action it resembles RCA's shadow mask—and forms an electron-optical lens system that lets more than 90% of the electrons through to the screen instead of the approximately 15% that get through the shadow mask. It also performs some of the functions of the Lawrence tube's grid, but differs distinctly in that the potential on it is fixed and no dynamic voltages are applied. All wires are at the same potential.

The faceplate of the tube is made up of vertical color stripes, about .012 inch wide in one of the experimental models shown. About 0.8 inch behind it, the grille—consisting of wires approximately .003 inch in diameter, spaced about .035 inch apart—is fixed. The phosphor screen is kept at a voltage of 25,000, the grille at 6,300. The voltage on the accelerating anodes of the electron guns is 6,500, 200 volts higher than the grille potential. Thus the beam is accelerated after deflection and is referred to as a post-deflection acceleration or simply as a post-acceleration tube.

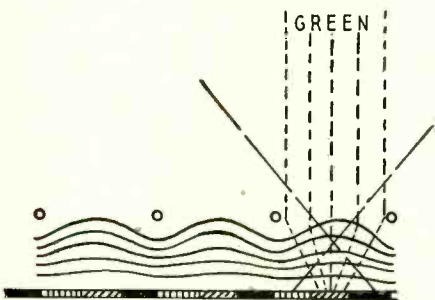

Fig. 2—Lines of equal potential make a sine-wave type pattern that flattens out as the screen is approached.

ation or simply as a post-acceleration tube.

Because of the difference in potential between the screen and the wire grille, the field between is so shaped as to form an electron-optical lens system that

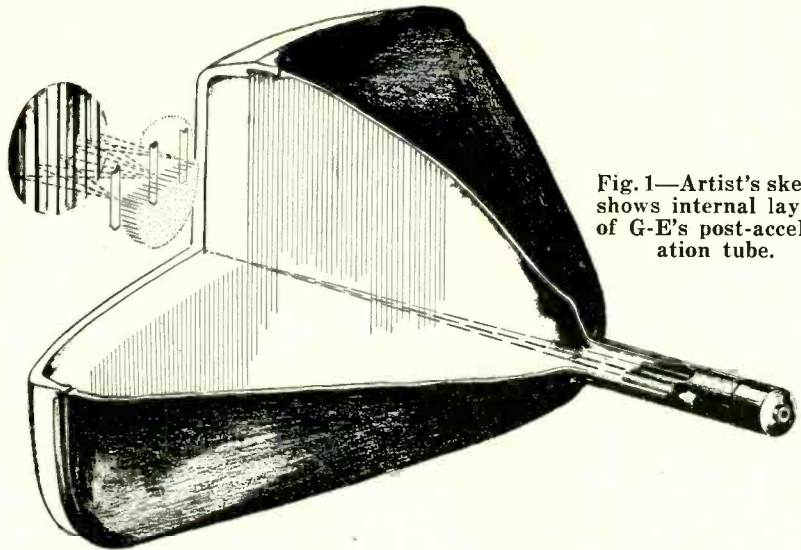

Fig. 1—Artist's sketch shows internal layout of G-E's post-acceleration tube.

bends as well as accelerates the electron beams. The lines of equal potential are indicated in Fig. 2. An electron tends to go in the direction of the highest potential—to cross the lines of equal potential at approximately a right angle. Thus, electrons that enter the grille region at a slight angle travel in a parabolic path toward the phosphor face.

*Direction selectivity* is the key of this tube's operation. As seen in Figs. 2 and 3, a beam coming straight down the tube will—in the section shown—be focused in a narrow strip in the middle of the vertical stripe halfway between the grid wires. A beam coming in from the left—represented by a single ray in Fig. 2—will, in trying to move in the direction of greatest increase in voltage, be focused toward the right, and the one from the right toward the left. (Angles as well as sizes in Figs. 2 and 3 are exaggerated to illustrate the action more clearly.)

Focusing action is an important factor in preserving color purity. The beam, which may be as much as .035 inch wide, is focused down to about .005 inch in the center of a .012-inch stripe, thus leaving ample "guard bands" on each side.

The progress of the beam across the screen is interesting. As the green beam—for example—continues toward the right in Fig. 3, part of it falls beyond the right grille wire. This portion is immediately deflected toward the center of the next green stripe, and as the beam continues to sweep it becomes stronger on that stripe as it becomes fainter on the preceding one. Thus each color "walks" across the tube, stepping only on its own color stripes and exciting them according to its own intensity, depending on the signal modulation.

## Advantages and disadvantages

One important advantage is that the tube requires less deflection voltage than one in which the beam is accelerated by the full screen voltage. The beam leaves the electron gun at 6.5 kv and, instead of being accelerated, sees ahead of it a slightly lower voltage—that of the grille. Thus the beam is much less "stiff" since the electrons are moving at relatively low velocity and need less power to deflect. The yoke is therefore much smaller than that required for present color tubes, using only about 40% as much copper.

The convergence problem is simplified by the in-line position of the guns. The central green beam is not controlled, and the two outside beams are made to converge with it. It is necessary only to move the two outside beams horizontally. This cuts the number of convergence controls in two and simplifies the work of convergence enormously.

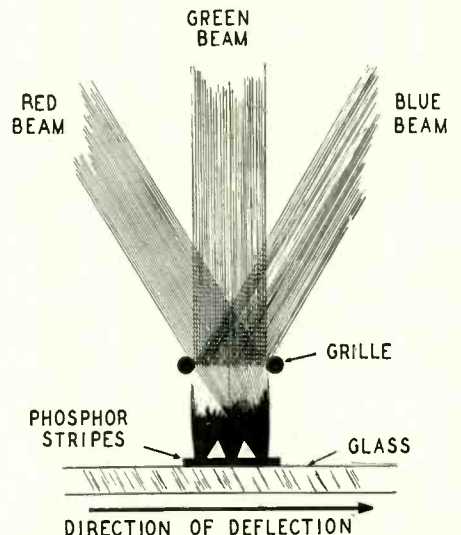

Fig. 3—Electron beams enter grille.

## THE ATOM-BOMB EFFECT

By JAMES A. McROBERTS

The greatest advantage of the new tube is brightness, which G-E engineers claim to be at least six times that of the shadow-mask type. Developmental models of the tube were demonstrated under conditions of normal night-viewing illumination (7 foot-lamberts), home daytime viewing (up to 50 foot-lamberts) and under illumination similar to the high-intensity lighting of the dealer's floor. Under both the latter conditions the post-acceleration tube showed up well, while the picture on the shadow-mask tube tended to wash out, especially under the strongest illumination. (A striking but unintentional result of the demonstration was to show that television dealers apparently prefer to demonstrate their sets under the worst possible conditions.)

The tube's brightness is accompanied by a disadvantage. Secondary electrons from the grille and those released from the screen itself strike the screen in a random manner and cause a slight white background and consequent loss of contrast. This result is most noticeable in a darkened room and is not as apparent under normal or bright lighting. The screen's brightness makes it possible to use a neutral-density filter type of safety glass with 50% light attenuation. This reduces the effect of external ambient light and tends to compensate for the loss in contrast.

The earth's magnetic field has been a factor in reducing purity and various means, including heavy mu-metal shields, purity coils or assemblies of permanent magnets around the tube face have been used to counteract it. Because of the vertical stripe pattern of this tube, the horizontal component of the Earth's magnetic field—which would cause the beam to move up or down—has no effect on color purity. Its vertical component, which would move the beam horizontally, is fairly constant over the United States and can be compensated for in the design of the equipment. Thus there is no need for heavy and expensive magnetic shielding.

Considering all the advantages of the post-acceleration tube, one is tempted to ask: "Why is it not immediately placed on the market?" The answer is that this is a developmental tube and problems of manufacture are still to be solved. Putting the phosphor on the face of the tube under production conditions is a feat still to be achieved. The tubes demonstrated were made up in "sandwich" form, with the grille and a flat phosphor-covered plate as a unit and inserted in the front of the tube. Incidentally, this caused some confusion in evaluating the tube's performance as one set gave noticeably better pictures than another of larger size, due not to any difference in the color sandwich but to a difference in the quality of the glass in the external faceplates.

The job of installing grille frames by factory mass-production methods has not been resolved as yet, but three approaches are being evaluated. END

PART of the picture on an intermittent RCA KCS72 chassis so resembled the now familiar cloud (see photo) of an atomic explosion that this particular trouble was dubbed "The Atom Bomb Effect" in the shop in which it occurred. All intermittents are service lemons; but this dog was particularly troublesome because it would "intermit" for only several seconds to about a minute at a time. Sometimes the trouble could be caused or cured by jarring or shaking the chassis. If the set was left alone, hours would pass with no sign of the trouble; then it would occur and quickly clear itself in a minute or less.

The intermittent would start as a sudden random tearout of several horizontal lines. The torn lines followed no particular pattern—the tearout might be at the top, middle or bottom—indicating that the trouble was not synchronized with the vertical sweep. Almost immediately, the height (vertical scan) would collapse to a vertical scan of about an inch and drop to the bottom of the picture tube. Occasionally it would drop slightly below the bottom, in which case moving the yoke would bring it into view. The atomic effect was above the horizontal stripe.

The horizontal deflection would remain apparently unaltered but no video information could be seen on any part of the vestigial raster. Varying the vertical hold control changed the appearance of the atomic effect and the frequency of the lines at the base of the "mushroom." The narrowed raster was much brighter than normal, as is almost always the case when the high voltage is unaffected but the size of the raster decreased.

The symptoms pointed to the vertical circuit, so the first test consisted of using a 60-cycle voltage to drive the vertical amplifier when the trouble reoccurred. A 0.1- $\mu$ f capacitor coupled the heater supply to the grid of the

vertical output tube through a switch. When the intermittent occurred, the switch was closed. There was a considerable vertical deflection which indicated that the vertical amplifier was functioning reasonably well. The position of the raster remained low, however, and the center line of the 60-cycle deflected raster remained in about the same position as the horizontal stripe. This indicated a possible defect in the vertical yoke. The collapse of the vertical scan with known deflection of the raster by a 60-cycle voltage at the grid of the vertical amplifier led to the suspicion that all was not well with the vertical oscillator. Loss of the video indicated that something was killing the signal.

A voltmeter was placed across the plate supply to the vertical oscillator and an v.t.v.m. across the B supply at the focus coil takeoff. The next intermittent showed that the B supply to the vertical oscillator failed. The main B plus remained practically constant, increasing very slightly. Finding the trouble was now very, very easy. The B plus lead to the vertical oscillator was traced. The trouble was a poorly soldered joint. The wire was mechanically hooked to the joint properly so that the trouble seldom occurred.

The plate of the vertical oscillator did have about 10 volts on it (through the high-resistance joint), which accounted for the failure of the vertical scan. During the intermittent the B feed to the 6AU6 a.g.c. tube and the grid of the 6SN7 horizontal sync separator was open. Likewise, the feed to the screen of video i.f. amplifier tube was open. This accounted for the loss of video in the raster, the loss of sync and the loss of vertical scan. The vertical oscillator was oscillating slightly, while squegging at a very low frequency. The squegging produced the atom-bomb effect and the influence of the vertical hold control on it. END



The Model  
TV-50

# GENOMETER

A versatile all-inclusive GENERATOR which provides ALL the outputs for servicing:

**A. M. Radio    F. M. Radio    Amplifiers    Black and White TV    Color TV**

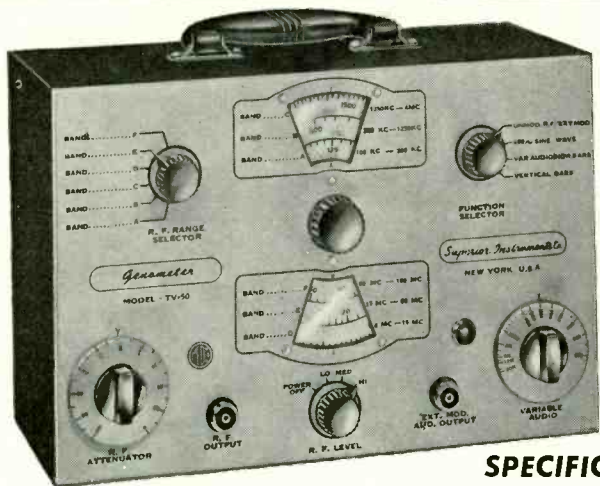

## 7 Signal Generators in One!

- ✓ R. F. Signal Generator for A.M.
- ✓ R. F. Signal Generator for F.M.
- ✓ Audio Frequency Generator
- ✓ Bar Generator
- ✓ Cross Hatch Generator
- ✓ Color Dot Pattern Generator
- ✓ Marker Generator

### SPECIFICATIONS:

#### R. F. SIGNAL GENERATOR:

The Model TV-50 Genometer provides *complete* coverage for A.M. and F.M. alignment. Generates Radio Frequencies from 100 Kilocycles to 60 Megacycles on fundamentals and from 60 Megacycles to 180 Megacycles on powerful harmonics. Accuracy and stability are assured by use of permeability trimmed Hi-Q coils. R.F. is available *separately*, modulated by the fixed 400 cycle sine-wave audio or modulated by the variable 300 cycle to 20,000 cycle variable audio. Provision has also been made for injection of any external modulating source.

#### VARIABLE AUDIO FREQUENCY GENERATOR:

In addition to a fixed 400 cycle sine-wave audio, the Model TV-50 Genometer provides a variable 300 cycle to 20,000 cycle peaked wave audio signal. This service is used for checking distortion in amplifiers, measuring amplifier gain, trouble shooting hearing aids, etc.

#### BAR GENERATOR:

This feature of the Model TV-50 Genometer will permit you to throw an actual Bar Pattern on any TV Receiver Screen. Pattern will consist of 4 to 16 horizontal bars or 7 to 20 vertical bars. A Bar Generator is acknowledged to provide the quickest and most efficient way of adjusting TV linearity controls. The Model TV-50 employs a recently improved Bar Generator circuit which assures stable never-shifting vertical and horizontal bars.

#### CROSS HATCH GENERATOR:

The Model TV-50 Genometer will project a cross-hatch pattern on any TV picture tube. The pattern will consist of non-shifting, horizontal and vertical lines *interlaced* to provide a stable cross-hatch effect. This service is used primarily for correct ion trap positioning and for adjustment of linearity.

#### DOT PATTERN GENERATOR (For Color TV):

Although you will be able to use most of your regular standard equipment for servicing Color TV, the one addition which is a "must" is a Dot Pattern Generator. The Dot Pattern projected on any color TV Receiver tube by the Model TV-50 will enable you to adjust for *proper color convergence*. When all controls and circuits are in proper alignment, the resulting pattern will consist of a sharp white dot pattern on a black background. One or more circuit or control deviations will result in a dot pattern out of convergence, with the blue, red and green dots in overlapping dot patterns.

#### MARKER GENERATOR:

The Model TV-50 includes *all* the most frequently needed marker points. Because of the ever-changing and ever-increasing number of such points required, we decided against using crystal holders. We instead adjust each marker point against precise laboratory standards. The following markers are provided: 189 Kc., 262.5 Kc., 456 Kc., 600 Kc., 1000 Kc., 1400 Kc., 1600 Kc., 2000 Kc., 2500 Kc., 3579 Kc., 4.5 Mc., 5 Mc., 10.7 Mc. (3579 Kc. is the color burst frequency.)

The Model TV-50 comes absolutely complete with shielded leads and operating instructions. Only \_\_\_\_\_

**\$47<sup>50</sup>**  
NET

**SHIPPED ON APPROVAL**  
**NO MONEY WITH ORDER — NO C.O.D.**

Try it for 10 days before you buy. If completely satisfied then send \$11.50 and pay balance at rate of \$6.00 per month for 6 months. **No Interest or Finance Charges Added!** If not completely satisfied return unit to us, no explanation necessary.

MOSS ELECTRONIC DISTRIBUTING CO., INC.  
Dept. D-190, 3849 Tenth Ave., New York 34, N.Y.

Please rush me one Model TV-50. I agree to pay \$11.50 within 10 days and to pay \$6.00 per month thereafter. It is understood there will be no finance, interest or any other charges, provided I send my monthly payments when due. It is further understood that should I fail to make payment when due, the full unpaid balance shall become immediately due and payable.

Name \_\_\_\_\_  
Address \_\_\_\_\_  
City \_\_\_\_\_ Zone \_\_\_\_\_ State \_\_\_\_\_

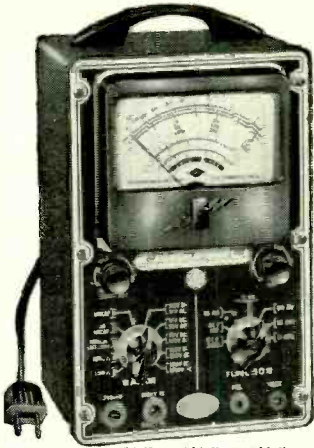

Measures 6 1/4" x 9 1/2" x 4 1/2"

Superior's new  
Model 670-A

# SUPER METER

A COMBINATION VOLT-OHM MILLIAMMETER PLUS  
CAPACITY REACTANCE INDUCTANCE AND DECIBEL MEASUREMENTS

**SPECIFICATIONS:**

D.C. VOLTS: 0 to 7.5/15/75/150/750/1,500/7,500 Volts  
A.C. VOLTS: 0 to 15/30/150/300/1,500/3,000 Volts  
OUTPUT VOLTS: 0 to 15/30/150/300/1,500/3,000 Volts  
D.C. CURRENT: 0 to 1.5/15/150 Ma. 0 to 1.5/15 Amperes  
RESISTANCE: 0 to 1,000/100,000 Ohms 0 to 10 Megohms  
CAPACITY: .001 to 1 Mfd. 1 to 50 Mfd. (Good-Bad scale for checking quality of electrolytic condensers.)  
REACTANCE: 50 to 2,500 Ohms 2,500 Ohms to 2.5 Megohms  
INDUCTANCE: .15 to 7 Henries 7 to 7,000 Henries  
DECIBELS: -6 to +18 +14 to +38 +34 to +58

**ADDED FEATURE:**

Built-in ISOLATION TRANSFORMER  
reduces possibility of burning out  
meter through misuse.

The Model 670-A comes  
housed, in a rugged  
crackle-finished steel  
cabinet complete with  
test leads and operating  
instructions.

**\$2840**  
NET

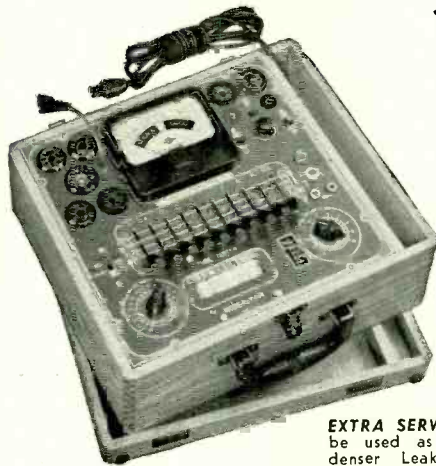

Superior's new  
Model TV-11

# TUBE TESTER

**SPECIFICATIONS:**

- ★ Tests all tubes including 4, 5, 6, 7, Octal, Lock-in, Peanut, Bantam, Hearing Aid, Thyatron Miniatures, Sub-miniatures, Novals, Sub-minars, Proximity fuse type, etc.
- ★ Uses the new self-cleaning Lever Action Switches for individual element testing. Because all elements are numbered according to pin-number in the RMA base numbering system, the user can instantly identify which element is under test. Tubes having tapped filaments and tubes with filaments terminating in more than one pin are truly tested with the Model TV-11 as any of the pins may be placed in the neutral position when necessary.
- ★ The Model TV-11 does not use any combination type sockets. Instead individual sockets are used for each type of tube. Thus it is impossible

to damage a tube by inserting it in the wrong socket.

- ★ Free-moving built-in roll chart provides complete data for all tubes.
- ★ Newly designed Line Voltage Control compensates for variation of any Line Voltage between 105 Volts and 130 Volts.
- ★ NOISE TEST: Phono-jack on front panel for plugging in either phones or external amplifier will detect microphonic tubes or noise due to faulty elements and loose internal connections.

The model TV-11 operates on 105-130 Volt 60 Cycles A.C. Comes housed in a beautiful hand-rubbed oak cabinet complete with portable cover

**\$4750**  
NET

**EXTRA SERVICE** — The Model TV-11 may be used as an extremely sensitive Condenser Leakage Checker. A relaxation type oscillator incorporated in this model will detect leakages even when the frequency is one per minute.

## About Testing Picture-Tubes . . .

Of course you can buy an "adapter" which theoretically will convert your standard Tube Tester into a picture-tube tester. Sounds fine—but—it simply doesn't work out that way!  
We do not make nor do we recommend use of C.R.T. adapters because a Cathode Ray Tube is a very complex device and to properly test it, you need an instrument designed exclusively to test C. R. Tubes and nothing else. As compared to a make-shift adapter, which sells for about five dollars, our Model TV-40

C.R.T. Tube Tester sells for \$15.85. But, if you believe that Television is here to stay, then you must agree that the difference in price is more than justified by the many years of valuable service you will get out of this indispensable instrument.  
Incidentally, the Model TV-40 is the ONLY low-priced C.R.T. Tube Tester, which includes a real meter. Neons are fine for gadgets and electric-line testers, but there is no substitute for a meter with an honest-to-goodness emission reading scale.



Superior's  
New Model  
TV-40

# C.R.T. TUBE TESTER

Tests ALL magnetically deflected tubes . . . in the set . . . out of the set . . . in the carton !!

- Tests all magnetically deflected picture tubes from 7 inch to 30 inch types.
- Tests for quality by the well established emission method. All readings on "Good-Bad" scale.
- Tests for inter-element shorts and leakages up to 5 megohms.
- Test for open elements.

**EASY TO USE:** Simply insert line cord into any 110 volt A.C. outlet, then attach tester socket to tube base (Ion trap need not be on tube). Throw switch up for quality test . . . read direct on Good-Bad scale. Throw switch down for all leakage tests.

Model TV-40 C.R.T. Tube Tester comes absolutely complete—nothing else to buy. Housed in round cornered, mottled bakelite case. Only

**\$1585**  
NET

**SHIPPED ON APPROVAL  
NO MONEY WITH ORDER — NO C.O.D.**

Try any of the above instruments for 10 days before you buy. If completely satisfied then send down payment and pay balance as indicated on coupon. No Interest or Finance Charges Added! If not completely satisfied return unit to us, no explanation necessary.

MOSS ELECTRONIC DISTRIBUTING CO., INC.  
Dept. D-190, 3849 Tenth Ave., New York 34, N.Y.

Please send me the units checked. I agree to pay down payment within 10 days and to pay the monthly balance as shown. It is understood there will be no finance, interest or any other charges, provided I send my monthly payments when due. It is further understood that should I fail to make payment when due, the full unpaid balance shall become immediately due and payable.

Name .....  
Address .....  
City..... Zone..... State.....

Model 670-A.....Total Price \$28.40  
\$7.40 within 10 days. Balance \$3.50  
monthly for 6 months.  Model TV-11.....Total Price \$47.50  
\$11.50 within 10 days. Balance \$6.00  
monthly for 6 months.  Model TV-40.....Total Price \$15.85  
\$3.95 within 10 days. Balance \$4.00  
monthly for 3 months.

By H. L. MATSINGER

*Slight changes in resistor and capacitor values raise havoc in TV receivers. So...*

# WATCH YOUR R'S AND C'S

**S**HANGRI-LA would hold no allure for the harassed service technician if all the faults in a TV or radio were *positive*. Tubes would be dead, never weak; coils would always open, never show intermittent resistance rise; resistors would open, never change value, and capacitors would invariably short, never be leaky or intermittently open!

But we live in an imperfect world, with imperfect electronic devices whose imperfect characteristics cause imperfect results. Otherwise there would be no repair jobs, so why worry? But it does make it necessary to spend some time in thoughtful analysis.

Radios would often hobble along with several defective parts; it would take a short or open to stop the set entirely. But in TV the least deviation from nominal values may cause erratic operation. In circuits where resistance or capacitance plays the leading role, an aging part which has changed value or developed leakage can be a troublemaker.

Composition resistors are adversely affected by extreme or prolonged heat, whether it be applied internally or externally. The molecules regroup and the resistance changes. These changes take place not only in the small insulated type, but also in the larger ones with ceramic cores.

Capacitors are subject to a variety of troubles—they may short, open, leak or change value. Consider the action which takes place within a capacitor in operation. When it is charged, the pressure on the dielectric is directly proportional to the voltage. With a.c., the pressure is alternately applied, removed and reversed, causing the plates and the dielectric to flex electronically and even mechanically in accordance with the frequency. You can see that the higher the frequency for a comparable voltage, or the higher the voltage, the greater will be the strain and stress set up within the capacitor. For reliability at the higher frequencies, silver plating on ceramic or mica is used.

Because high currents flow in this circuit, the screen and cathode resistors may change in value. When the horizontal sweep becomes insufficient, and the sides start to creep in, the resistors may be the trouble. Normal practice is to suspect the output tube, but often replacement gives only temporary improvement and after a week or so the sides start to creep in again. If this happens to you, don't pull out what little hair you have left—check those resistors.

You can usually check the screen resistor without pulling the chassis by measuring between the screen prong of the output socket and the low side of the flyback transformer or the plate of the damper tube, depending upon the circuit. If the resistor is more than 20% above the listed value (or the tolerance given for the particular unit), replace it.

With a circuit like that in the Du Mont RA-116A, a variable resistor in the screen lead is used as the horizontal size control, and resistor changes are not necessary. The cathode resistor can usually be checked by measuring between cathode and ground. Replace an off-value resistor with one of the next higher wattage rating.

Except for the horizontal drive control, often an adjustable ceramic or mica, most of the capacitors associated with the output circuit, the flyback transformer and damper tube will be of the paper dielectric type. Complete breakdown resulting in a short circuit is the usual trouble and is not too hard to find. But once in a while a capacitor will open, causing nonlinearity which cannot be corrected with the control provided. Unless you have a capacitor tester, substitution is your best bet.

### Horizontal phase and ratio detectors

Resistor troubles in these circuits are the penalty of mass-production methods. Manufacturers buy resistors by the tens of thousands and, except for spot checks, color coding is accepted at its face value. Too often, however, two resistors representing the high and low tolerance limits may be used as load resistors (Fig. 1) where it is important that the values be matched. Obviously, if the 100,000-ohm resistors are not equal, the amplitude of the respective voltages appearing across these resistors will be dissimilar. When the tube, usually a 6AL5, is new, this may not make much difference but with age the effect becomes more pronounced. In the ratio detector you may get some audio distortion while unbalance in the horizontal phase detector can cause instability in the horizontal circuit.

Capacitors used in the ratio detector are usually mica and will seldom give trouble, but faulty capacitors in the de-emphasis filter will cause an excess of high-frequency response. In some

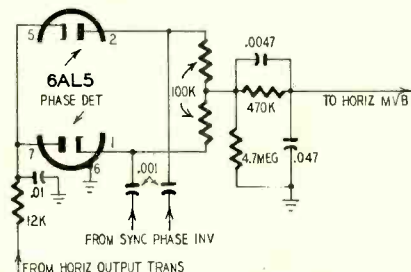

Fig. 1—Schematic diagram of the horizontal a.f.c. circuit in the Admiral 21W1.

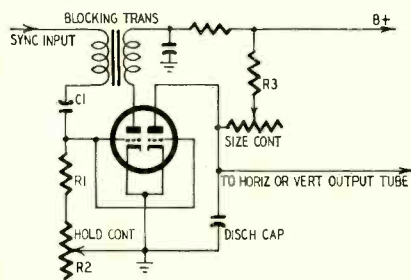

Fig. 2—Typical blocking oscillator.

circuits, the load resistors are shunted with capacitors which should be matched for best results. The electrolytic stabilizing capacitor must be able to hold a charge or the audio will suffer. A breakdown of this unit will cause a loss of audio.

### Horizontal and vertical oscillators

A very common service complaint is failure of the horizontal and vertical hold controls to function correctly. Faulty tubes play a big part in the loss of sync, but when you are repeatedly called to correct the same evil, it is time to look farther. Fig. 2 shows the basic circuit of a blocking oscillator. Most sets use an adaptation of this hookup or of that of the multivibrator shown in Fig. 3. They are similar, the primary differences being the manner in which the synchronizing pulses are introduced and the method by which the oscillations are sustained. Control of frequency and amplitude can be identical.

In some sets the heating of R1, R2 or C1 may cause drift during the first hour of operation, or the action may be continuous, with frequent adjustment necessary. Fig. 3, with R3, R4 and C2, has an additional source of drift. Circuits which use frequency coil L are usually more stable than those which depend upon an R-C combination for frequency control. With the coil, an open or leaky C2 will cause loss of horizontal control.

The Bendix model 2051 is a good example of a TV set using the simple multivibrator for the horizontal sync. In some of these sets the horizontal hold control must be advanced as the set warms up. After an hour or so of operation its range limit is reached, making sync impossible. Changing the 6SN7-GT's is not the right answer for it is often necessary to try four or five tubes before you get one to work satisfactorily. A better approach is to replace C1 (Fig. 3) with a silver mica type having a zero temperature coefficient, and R1, R3 with units having the next higher wattage rating. Horizontal hold will still be critical, but more stable.

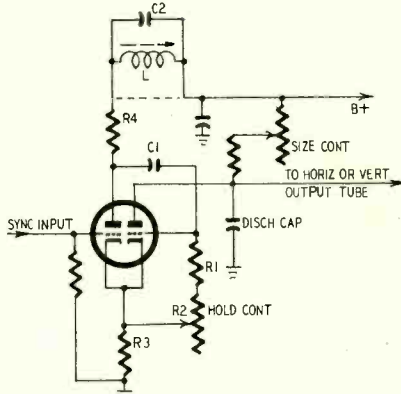

Fig. 3—A typical TV multivibrator. Dashed line indicates circuit when tuned network L-C2 is not used.

A somewhat similar condition will occur in many vertical sync circuits. After a short period of operation retrace lines flash across the picture and the horizontal blanking bar appears, sometimes followed by a slight roll. Replacing the grid capacitor C1 together with the fixed and variable hold resistor will often eliminate this condition.

### High-voltage filter

The resistors and capacitors which make up the high-voltage filter are very susceptible to trouble. Dirt and dust become ionized and adhere to the surfaces of these units, forming low-resistance paths. This can result in blooming when the brilliancy control is advanced. A good rule to follow is to replace any of these components which looks at all doubtful.

### Sync separator, amplifier and integrator

Peak voltages found in these circuits are generally around 20 to 40, and very seldom will you encounter resistor trouble. Capacitors, however, may short, open or leak, disrupting normal operation. This is especially true of the integrator. Here we build up a number of short pulses into a triggering voltage for the vertical oscillator. Leakage cannot be tolerated. A good sync pulse will bring the vertical hold in with a bounce that will momentarily compress the picture. When you get a shallow sort of lock in, replace the capacitors with silver mica units.

### Miscellaneous trouble points

It is obviously impossible to list in one short article all the points where trouble will develop from faulty resistors and capacitors. We have tried to list the most common. Some miscellaneous trouble points are as follows:

If the set develops a wavy section in the upper right or left corner of the picture, this is often caused by an open balancing capacitor in the horizontal deflection coil. A shorted capacitor or coil will cause keystoneing.

Another trouble point is the brightness control. A shorted capacitor in this circuit will give you one of those no-picture no-raster deals while an open resistor will make it impossible to control the brightness. Naturally you have no alternative but to replace the faulty part.

Faults caused by imperfect resistors and capacitors in the r.f., i.f. and a.g.c. circuits give very much the same effect in TV as they do in conventional radios, and they are located in much the same manner. If you agree that you cannot judge a book by its cover, you will look with suspicion upon every resistor and capacitor in a circuit which is itself suspect. Even units that look good should be checked, but if there is any sign of blistering, bubbles or melting wax, be doubly suspicious. END

# Rainbow Patterns

## with Conventional Generators

By ROBERT G. MIDDLETON\*

**S**ERVICE technicians in the larger cities are becoming familiar with the rainbow type display on a color TV picture tube. Rainbow patterns are very easy to produce; all that is required are a pair of conventional signal generators and a crystal diode (Fig. 1). The generators are in parallel and feed their combined output through the crystal diode which operates as a modulator. The modulated out-

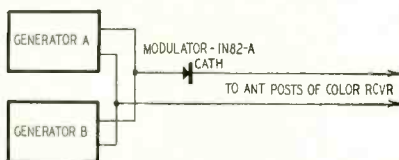

Fig. 1—Generators and diode provide rainbow patterns in color receiver.

put from the arrangement is applied to the antenna input terminals of the color TV receiver which then develops the rainbow pattern on the screen.

The system operates by a method known as the *offset* color subcarrier. In other words, generator A is tuned to 3.58 mc, plus (or minus) a given number of horizontal scan intervals (15,750 cycles). If it is set to a frequency of 3.58 mc plus 15,750 cycles, one rainbow is produced.

Turning generator A to 3.58 mc plus two horizontal scans (31,500 cycles) produces two complete rainbows with part of the second lost during the fly-back interval. As many rainbows can be obtained as generator A is offset by a given number of horizontal scans. If the generator A is set in between a horizontal scan interval, varying numbers of diagonal rainbows appear.

Generator A should be set to deliver a CW signal; if the output is modulated by 400 cycles for example, the rainbows will be cut up by black horizontal bars. Generator B must be set to the channel for which the color TV set is tuned and should be set to provide a picture carrier frequency output. The output from generator A modulates the output from generator B so that sidebands are generated at the color subcarrier frequency (offset by the chosen number of horizontal scans).

The principle of operation of the arrangement is as follows: The color sub-

carrier oscillator in the receiver operates at 3.58 mc and when a signal which is offset in frequency (such as 3.58 mc minus 31,500 cycles) is fed into the chrominance circuits, the vector voltage of the offset color subcarrier rotates with respect to the vector voltage of the color subcarrier oscillator. Each individual phase angle occupied instantaneously by the offset color subcarrier defines a hue, as shown in Fig. 2. Since this vector voltage is continuously rotating at an exact multiple of the horizontal scanning frequency, it sweeps through a rainbow of defining hues, returning to its starting point at the end of the horizontal scan interval.

The output from the arrangement shown in Fig. 1 is a constant modulated voltage so that the level of the offset color subcarrier does not change from one hue to the next. Neither does the

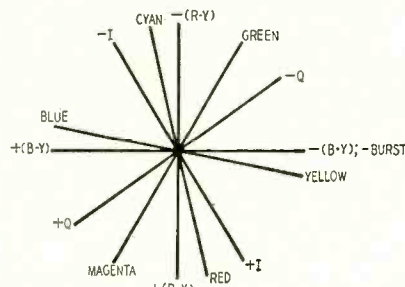

Fig. 2—Diagram shows phase relations of various hues defined in rotation of offset color subcarrier voltage vector.

arrangement provide a Y component in the output signal, and all hues have an average value coincident with each other. Hence, although all hues are implicit in the offset color subcarrier vector, true colors are not obtained in the rainbow display, which appears dim and bluish as compared with the display provided by a true color bar generator. When true saturated colors are generated, the voltages provided by the generator supply a 3.58-mc signal at the proper phase angle to define a hue and at a suitable voltage to produce a saturated color as required by the chrominance circuits. Also, the generator provides a Y (brightness) voltage which appears as a "crankshaft" signal when the color subcarrier is stripped off. Each hue requires a certain individual level of Y voltage to display a saturated color.

Some of the more important voltage relations are shown in Fig. 3.

Why does the rainbow display appear dim and bluish? The dimness results from elimination of the brightness component. A false brightness component can be inserted into the display by advancing the brightness control of the receiver somewhat beyond its normal setting. However this inserted brightness component has a constant value and does not change from hue to hue as required for true saturated colors. The bluish cast of the rainbow pattern results from the relative Y component contained by the various hues. Yellow, for example, contains 89% Y component and is most affected by its removal. Hence, yellow is almost invisible in the rainbow display. Blue has only 11% Y component and is least affected by its removal. Hence, the other colors appear bluish in the rainbow display.

The arrangement shown in Fig. 1 does not provide sync or burst. Because sync is lacking, the AM generator must be tuned with some care to obtain a stable pattern. Vertical sync is not required in such displays since only vertical bars are developed, and rolling is

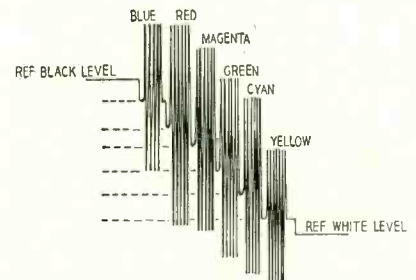

Fig. 3—Voltage relationships when true saturated colors are generated.

either invisible or appears only as a drift of the residual hum pattern.

The lack of burst does not inhibit operation of the color sync circuits in the receiver will lock in on some average phase of the signal. But it would be a difficult matter to attempt to use this to adjust the color phase control of the receiver, since a reference is not obtainable without a scope.

However, the rainbow pattern will show whether various sections of the chrominance circuits are operative, as may be seen by unplugging the R - Y demodulator, B - Y demodulator, etc.

The arrangement shown in Fig. 1 is instructive and is of some use in servicing. Since conventional black-and-white equipment can be used, it should be of interest to the small shop.

An r.f. sweep generator can be used in the arrangement if the sweep-width control setting is reduced to zero. Should the output from the r.f. generator be frequency-modulated, severe pattern disturbances will result. In any event, no matter what type of generator is used, output should be sufficient to drive modulator and receiver circuits at a satisfactory level. END

\*Chief Field Engineer, Simpson Electric Co.



P. R. MALLORY & CO. INC.  
**MALLORY**  
APPROVED PRECISION PRODUCTS

P. R. MALLORY & CO. INC.  
**MALLORY**  
APPROVED PRECISION PRODUCTS

P. R. MALLORY & CO. INC.  
**MALLORY**  
APPROVED PRECISION PRODUCTS

# Extra Vibrator Performance... without Extra Cost

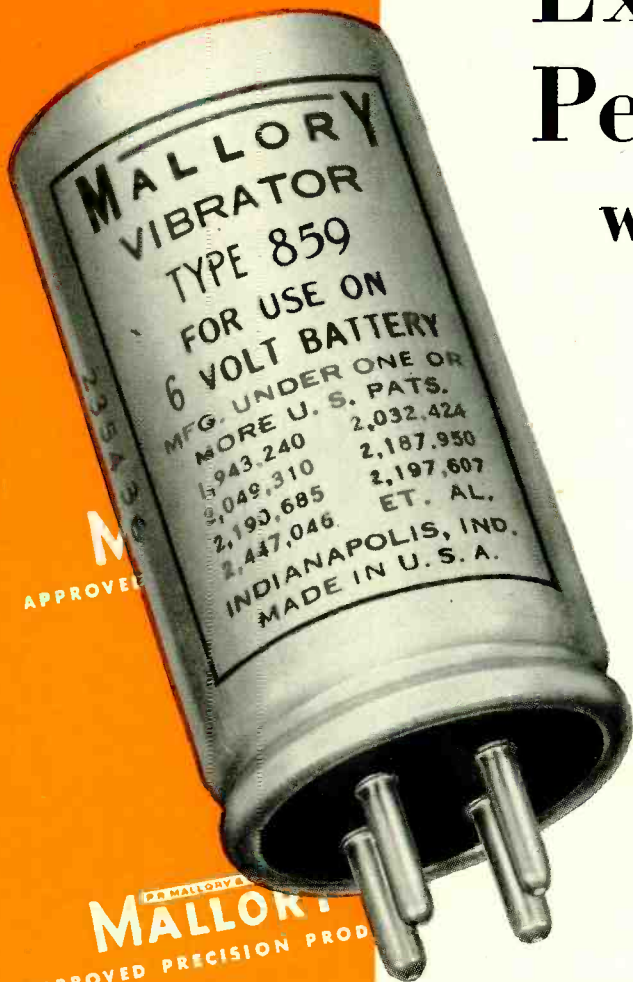

IN THE MALLORY 25th ANNIVERSARY VIBRATOR,\* mechanical hum has been squelched right at its source. In any mounting position . . . prongs up, side-wise, or prongs down . . . this is the quietest vibrator ever. And it costs no more than the previous Mallory vibrators which it replaces!

**TOP ELECTRICAL PERFORMANCE**—for hundreds of hours. These test oscillograms show how Mallory vibrators are adjusted to excellent wave form, and continue to produce this performance for hundreds of hours. Note that even after long service, the 'scope shows complete freedom from hash, off-frequencies or variations in amplitude . . . no evidence of contact chatter or bounce.

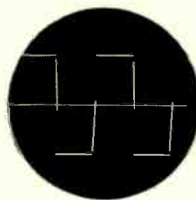

Ideal vibrator wave form

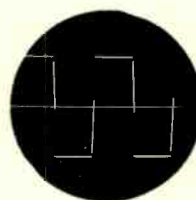

New Mallory vibrator

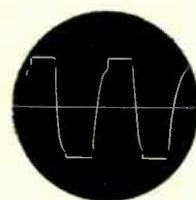

Mallory vibrator after hundreds of hours of service

In every respect, the new Mallory vibrators live up to the reputation for long, dependable service which has made Mallory vibrators the leading choice of servicemen and manufacturers.

Your Mallory distributor carries the new models, with part numbers identical with those you've been using. Call him soon . . . and order your supply of the quietest vibrators you've ever used.

\*Patent Applied For

P. R. MALLORY & CO. INC.  
**MALLORY**  
APPROVED PRECISION PRODUCTS

P. R. MALLORY & CO. INC.  
**MALLORY**  
APPROVED PRECISION PRODUCTS

APPROVED PRECISION PRODUCTS

APPROVED PRECISION PRODUCTS

P. R. MALLORY & CO. INC.  
**MALLORY**  
CAPACITORS • CONTROLS • VIBRATORS • SWITCHES • RESISTORS  
RECTIFIERS • POWER SUPPLIES • FILTERS • MERCURY BATTERIES  
**APPROVED PRECISION PRODUCTS**  
P. R. MALLORY & CO. Inc., INDIANAPOLIS 6, INDIANA

P. R. MALLORY & CO. INC.  
**MALLORY**  
APPROVED PRECISION PRODUCTS

P. R. MALLORY & CO. INC.  
**MALLORY**  
APPROVED PRECISION PRODUCTS

P. R. MALLORY & CO. INC.  
**MALLORY**  
APPROVED PRECISION PRODUCTS

# Those deadly intermittents

By ART MARGOLIS

*What do you do when  
a good customer  
blows his top  
over a big  
"intermittent" bill?*



"... I reasoned it was the filament in the picture tube or the 6W6 damper."

**H**OW many times has that intermittent on the far bench misbehaved in the last 10 days so you could work on it? How many times has the owner called, pleading, crying and screaming for it back? And how much money are you going to lose when you total up the futile agonizing labor hours?

Due to the importance of the intermittent problem our company had to work out some definite policies for a receiver so stricken. Even though these common-sense policies are far from spectacular, by sticking to them religiously we have had amazing, customer-calming, money-saving results.

Webster innocently and simply defines intermittent as "coming and going at intervals." The main trouble I find with TV intermittents is they go when I come and they come when I go!

The first thing I do, when I come and the trouble has departed, is turn into a persistent inquisitor. I try to glean from the set owner everything he can

possibly remember about the escaped harasser.

I was out servicing a 12-inch Philco. The customer was complaining of occasional loss of picture but of course when I arrived the video was glaring at me. I began firing questions. The first thing I learned was the complete raster was leaving, not just the video. That led the interrogation into the vein of high voltage. I then learned the picture was not snapping off but fading away slowly. That more or less eliminated the 1B3 high-voltage rectifier and the 6SN7 horizontal oscillator. I then managed to dig out that during the fading there was no shrinking at all. That sort of put the 6BG6 horizontal output and the 5U4 low-voltage rectifier in the clear.

Hopefully, I reasoned it was the filament in the picture tube or 6W4 damper. I ceased my inquisition and jiggled the dickens out of the two tubes under suspicion. Lo and behold—the damper filaments faded languidly away

like the proverbial old soldier. A few Sherlock Holmes questions plus a new damper neatly solved what could have been a nasty intermittent.

Like any good cross-examiner, you must be careful in considering the facts a technically ignorant set owner will offer you. Unwittingly they can throw traps in your way.

I was called to look at a 12-inch three-way Magnovox that was having spells. Using the same investigating routine as with the Philco, I found what seemed to be a similar case: spasmodic loss of raster, slow fading and no shrinking. Again I jiggled the picture tube and damper but this time to no avail. The set was pulled into my shop.

A couple days later we caught the trouble. The information about the raster loss, slow fading and no shrinking, while literally accurate, was technically worthless. For when the disturbances took place the raster bloomed and the 1B3 would wink blue as it caused the trouble.

Once I receive some inkling of the trouble, I take some definite action. If a set has troubles but they are not occurring, I try to persuade them to happen.

I was out examining a 21-inch RCA. The customer told me that every now and then his picture would shrink up about halfway. I turned into a glass-pecker and went tap-tap-tapping into the vertical sweep circuits. Nothing happened. Before pulling the chassis I decided to poke around the rest of the set. Going down the line, tube after tube, I struck gold. The customer who was watchdogging the screen for me suddenly yelled, "You got it, you got it!" Glancing into my setup mirror I saw a textbook example of 60-cycle hum in the video. The entire bottom half of the picture was blacked out. It was a heater-to-cathode short in the 6BQ7 r.f. amplifier. That was the vertical trouble.

You must be careful when you try to induce the intermittent condition. Like the time I walked in on a 21-inch Silvertone. It was acting fine when I arrived. The customer described to me what sounded like a lead-pipe cinch case of fixed brightness due to a short in the electron gun.

I began tapping the neck of the picture tube. The set owner frowned at this procedure. But I was dead right, for only two or three slight knocks brought on the fixed brightness. I informed my client she had a bad picture tube. She plopped into a chair and took a deep breath. Hand over heart she told me that due to financial embarrassment the job would have to wait a while. Then she politely asked me to restore the picture to the way it was when I came in. I began tapping some more with my rubber hammer. The fixed brightness refused to budge. I hit it a few times with a screwdriver. The condition ignored me. To save my life, I could not get those shorted elements to part.

In the end I was practically thrown out of the house without my service charge. The worst part was the irate customer honestly believed that I broke her picture tube on purpose. All in all though, persistent interrogation and an ambitious set-poking can bring to light a lot of the easier intermittents.

Sometimes the questioning hints at an easy-to-locate disturbance but set-prodding won't induce the spasm to take place. To avoid pulling the chassis, you can enlist the owner's aid.

I had a 21-inch Philco whose owner was complaining about a white border appearing on the bottom of the picture. I gave her these instructions: Watch the TV set as usual. As soon as the vertical foldover begins call right in and leave the set on while waiting for me to arrive. The next afternoon she called. I found the defect. I made out a bill for two service charges and a 6S4 vertical output tube, instead of the high-priced chassis pulling and bench labor charges.

Another time a customer was being tormented by intermittent rolling on his 21-inch Muntz. The end result had a satisfied customer and me two more service charges and the price of a 6BL7 that had been doing the dirty work.

The main thing is, keep your instructions simple. I gave a woman owner of a large Du Mont these same intermittent-snaring instructions, but she mixed them up a little bit. On a Monday morning I told her: "Watch the TV set as usual. When the trouble starts, call right in and leave the set turned on while you are waiting for me to arrive."

That Friday evening we received a call, but the intermittent hadn't acted up yet. She told the astounded operator, "The TV has been playing day and night now for five days. We would like to go away for the weekend. Is it all right if we turn it off?"

#### When chassis must be pulled

These customer interrogations and set-poking measures are still only first aid. The rub comes when these easy checks fail. Then the chassis must be pulled and placed under observation.

When an intermittent-harboring chassis is pulled, dire circumstances are created. You have filched from a TV-viewing addict his evening kicks. The days or perhaps weeks you spend in tracking down the subtle spasmodic trouble leave the set owner staring at an empty TV cabinet from whence no entertainment will shine. As his evenings elapse, his aggravation vented toward you will mount.

I remember a 21-inch Du Mont that had to be pulled for intermittent loss of raster. Only once every few days would it favor us by going off. After two or three observations we began making tests. We ascertained that the high voltage was not at fault. The next time it went off we switched channels and discovered a raster on an inactive channel. That drew us into the keyed a.g.c. circuits. We began a tedious substitution-and-wait procedure.

Meanwhile 10 days elapsed with the customer calling so regularly every day you could synchronize your watch. Each phoning raised his voice about an octave. The tenth day had him calling as usual, but somehow he sounded different. He asked me in a choked voice to come out and service his second set. I didn't remember him having a second set but, glad to be of service, I dashed over there. When I knocked on the door, he opened it slowly and quickly wrenched my tube caddy out of my hands. The door slammed in my face.

I called the shop for instructions. They informed me that the last substitution of the .001- $\mu$ f 2,000-volt capacitor from the high-voltage transformer to the plate of the 6AU6 a.g.c. keyer (Fig. 1) had held up. The previous capacitor was leaking and putting a heavy positive bias, through the a.g.c. system, onto the r.f. and i.f. grids.

These hot-running tubes were then producing so much detected signal that the video was cut off. That was the intermittent trouble.

I drove back to the shop, picked up the chassis, stopped in at the local constabulary and with two husky members of the bandit patrol delivered the chassis. Actually though, I didn't need the policemen for the customer gladly paid

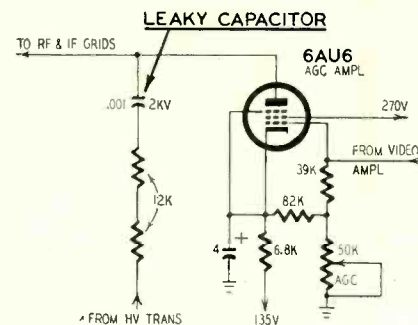

Fig. 1—Schematic of a.g.c. amplifier.

his bill and returned my untouched tube caddy. All these melodramatics could have been avoided if this habitual viewer had been supplied with some form of TV. Since then we have found it highly profitable in keeping goodwill and reducing customer-waiting aggravation to have a few small-screen loan-outs available.

#### Clarifying the price

A thing we make crystal clear with the customer before hauling an intermittent into the shop is price. We painstakingly explain, as tactfully as possible, that an accurate estimate for this type job is well nigh impossible. And since it is a serious and difficult undertaking they should be prepared for a large repair bill. If the set owner won't go along with this, we won't accept the job. Only a fool works for nothing or does a job and loses money, and fools can't last in the TV service business very long. Here's how smooth such a difficult repair job can go:

One of the boys was dispatched to a complaint on a 19-inch Admiral. Naturally the set was performing like new when he arrived. He pieced together the symptoms—intermittent loss of raster. He informed the set owner he had a deadly intermittent that was going to be expensive, made arrangements for a loanout set and then pulled it into the shop.

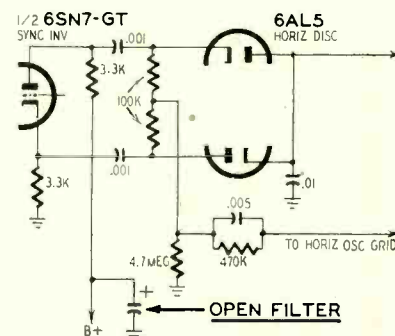

Fig. 2—Horizontal discriminator circuit.

# NOW HEAR THIS

for  
improved high fidelity

## GOODMANS LOUDSPEAKERS

in the New  
**'Friction-Loaded'**  
AXIOM Enclosures

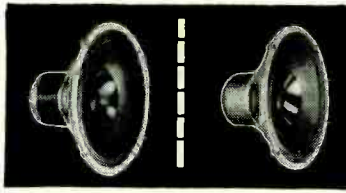

Axiom 22 Mk II      Axiom 150 Mk II

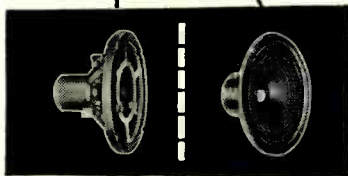

Axiom 80      Axiette

Complete do-it-yourself construction  
details — available on request

Mail this Coupon... Today

ROCKBAR CORPORATION Dept. NM-9  
215 East 37th St., New York 16, N. Y.

Please send me:

- Complete information about GOODMANS High Fidelity Loudspeakers.
- Complete details about the new 'friction-loaded' AXIOM Enclosures.

NAME.....

ADDRESS.....

CITY..... ZONE..... STATE.....

## TELEVISION

The first seizure took place about 3 days later. Some frantic checks showed no high voltage and the horizontal oscillator way off key. The attack lasted long enough for us to check the oscillator and output circuit. The tubes and parts were O.K. The loss of oscillator frequency was caused by a positive 20 volts on the oscillator's sync input grid.

About a week later the next fit took place. Pulling out the 6AL5 horizontal sync discriminator (Fig. 2) restored the oscillator's 15,750-cycle whistle, the raster popped on, but of course it was out of sync. Voltage checks showed the misplaced 20 volts was coming from and being developed across the discriminator's 10,000-ohm balancing resistors.

The next time it popped off we were waiting with a scope. Following the sync signals out of the sync stages it was fine till it entered the 6SN7 sync inverter tube. The sync signal appearing at the plate seemed to be in phase with the signal at the grid. The inverter tube was not inverting. A closer analysis showed distorted signal and the plate voltage about 10 volts low.

We changed the B plus filter in the plate supply. That did it. The filter was intermittently opening and throwing lots of ripple into the sync inverter plate circuit. That in turn was ruining the horizontal sync discriminator to develop a positive voltage on the wrong end of its balancing resistors. This positive voltage was then being transferred to the horizontal oscillator grid. The positive voltage messed up the horizontal frequency manufacturing. This wrong frequency caused a chain reaction, killing the high voltage. Whew!

You can imagine all the trying hours spent on this toughie. I only hit the highlights. However, the adequately briefed customer paid his expensive bill and was satisfied.

Lots of times, under these conditions, you can give the customer a pleasant surprise. I was out on a 12-inch Philco

that would play for a while and then the raster would pop off. I was able to do some checking in the house. I discovered there was always good high voltage, raster or not. However, when the raster popped off I could draw a

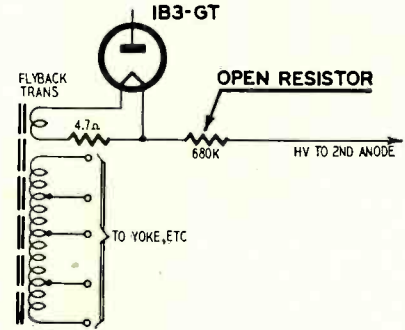

Fig. 3—High-voltage supply circuit.

high-voltage arc to ground but I could not draw one to the second-anode terminal. I told the customer that, to the best of my knowledge, it looked like an intermittent open cathode in the picture tube. Since it was intermittent, I pulled it into the shop.

Less than an hour on the bench revealed it was not the picture tube. The 680,000-ohm limiting resistor (Fig. 3) between the IB3 cathode and the second-cathode terminal was making and breaking. It was hard to convince the customer that I wasn't kidding when I handed him a bill for about half of what I had sold him on.

Anyway, if you can repair an intermittent receiver in the house by the interrogation-and-poke method, that is the thing to do. However, if the chassis must be pulled, don't leave the TV habitué without his pix and don't surprise him with a staggering repair tab.

If you keep TV watchers as comfortable as possible during the empty-cabinet ordeal and make sure they know the service bill is going to be high, you will virtually eliminate customer pressure and actually turn those deadly intermittents from a nagging expense to a sweet morsel of profit. END



SALERNO

"A couple of neighbors are having trouble with their sets—check these for me."

# IN RETURN FOR CHARACTER ... A CAREER

Because the finest single attribute anyone can offer is character, this, basically, is what IBM asks of its people, whatever their special aptitudes or abilities. IBM offers them in return—not just a job—but a career.

IBM electronic field technicians, for instance, receive more than training and early responsibility; they have a chance to work with the world's largest computer, use the latest testing equipment, employ

the finest computer testing techniques yet devised. Above all, they have the satisfaction of joining the electronics industry's most advanced program, destined for long-range national importance.

You could ask for no finer future.

*If you are between 19 and 32 and have at least a 2-year technical school background, with emphasis on electronics, you can do important work on COMPUTER INPUT-OUTPUT functions. Write: Nelson O. Heyer, IBM, Room 3112, Neighborhood Rd., Kingston, N. Y.*

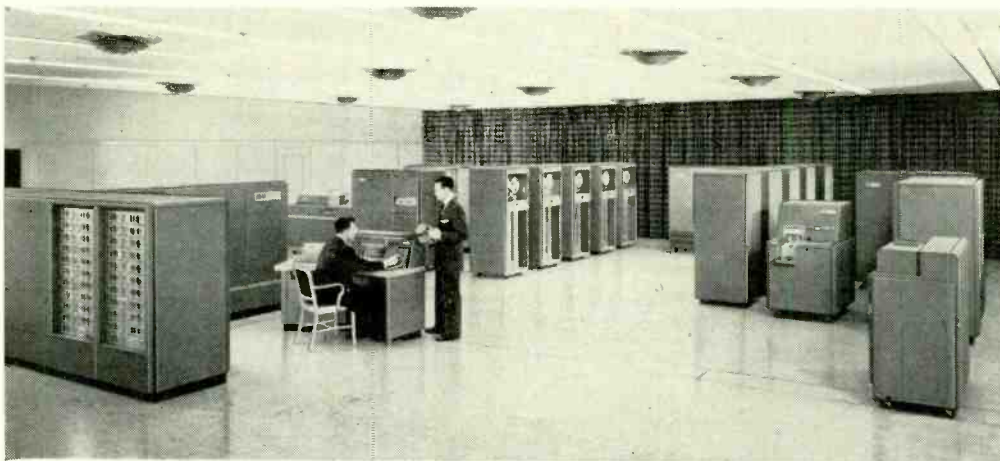

*The 702 Electronic Data Processing Machine, typical of advances that have made engineering work at IBM one of the most provocative experiences in electronics.*

INTERNATIONAL BUSINESS MACHINES CORPORATION

**IBM**  
®

Producer of electronic data processing machines, electric typewriters, and electronic time equipment.

## TELEVISION

### *A simplified procedure for adjusting TV circuits*

By CHARLES G. BUSCOMBE

**M**ANY technicians bog down when it comes to aligning a TV receiver. Actually no more difficult than other phases of servicing, for one reason or another it is often avoided like a plague. When asked, the average technician may give you several reasons for not getting involved in an alignment job. He is much too busy. Or customers are often unwilling to pay for the time required to do the job properly. (This may be true where before-and-after improvements are apparent only to the trained observer.) Too often the real reasons for the technician's steering shy of alignment are his limited ability and familiarity with the necessary test equipment.

There are many reasons why a TV set may go out of alignment: normal aging of components, rough handling during transit, vibration over a period of time, or possibly the set slipped by final factory inspection without proper testing. Chances are, if a set has been serviced a number of times, somewhere along the way it has fallen into the hands of a screwdriver mechanic, possibly the owner himself.

Symptoms of misalignment can often result from other troubles in the receiver, so the technician must be able to evaluate such symptoms and not be too hasty in attempting alignment that may not be necessary.

#### Pix i.f. alignment

Trouble symptoms that may indicate misalignment of picture i.f. strip are poor contrast, loss of picture detail, a smeared or streaky picture, unstable sync, poor picture-sound tracking (where best picture and sound are not received simultaneously). There are several methods of tuning this section, the most popular one using a modulated r.f. signal and a v.t.v.m. The procedure is simple. Connect the v.t.v.m. between the signal input of the picture tube and chassis. Using the gain of video amplifiers in this way provides maximum meter sensitivity, making it possible to keep the generator output at a very low level. The meter is set for a low a.c. range.

Couple the signal generator to the mixer tube, preferably to an ungrounded shield slipped part way down on the tube. To keep the shield in a fixed position, squeeze it slightly. Do not apply the generator to the first i.f. grid; the input i.f. coil is invariably on the tuner and loose coupling from the generator is important. After making the connections it is simply a matter of de-

termining the proper frequency for each i.f. coil, tuning the generator alternately to each frequency and adjusting the coils individually for maximum meter deflection. Where there are traps in the i.f. strip, adjust them for maximum dip on the meter.

The entire procedure should be repeated at least twice, each time with the generator well attenuated and using the lowest possible range on the v.t.v.m. The antenna should be disconnected during alignment to prevent meter deflection from external signals and noise interference. The a.g.c. circuit should also be disabled and a fixed bias substituted. Many technicians prefer to align the pix i.f. strip with a grid dip oscillator. This method is fast and reasonably accurate but can be used only where i.f. coils are exposed and not enclosed in shield cans. The procedure is first to determine the frequency each coil is tuned to. This is done by holding the grid dip meter near each coil, tuning the instrument for maximum dip on its meter and reading frequency on a calibrated dial scale. Coils that are not resonant to the manufacturer's specs can be corrected by tuning the grid dip meter to the proper frequency, coupling it to the coil in question and adjusting the slug for maximum dip.

(Only a few of the more expensive grid-dip meters are accurate enough for alignment of TV i.f. circuits. The g.d.o. is most useful when the circuits are so badly out of alignment that a signal generator cannot feed a signal through on the desired frequency. In this case, the g.d.o. may be used to check the circuits and bring them into rough alignment after which the signal generator can be used to complete the job.—*Editor*)

Visual alignment, as used by set manufacturers, is considered the most accurate method. Unfortunately, it is not popular with all technicians for several reasons. Besides requiring the use of several expensive instruments,

it is somewhat complicated and difficult to understand.

#### Visual alignment

Knowledge and familiarity with the instruments involved—the oscilloscope, sweep and marker generators—is of prime importance. Almost any type scope can be used provided it has adequate sensitivity and frequency response. Any source of unmodulated r.f. can be used as a marker signal but it *must* have accurate frequency calibration. The sweep generator produces an FM signal, usually modulated at a 60-cycle rate with a deviation or sweep control calibrated up to 10 or 15 mc.

At least 50% of the difficulties experienced with this method are in setting up the instruments, their adjustments, and interpretation of patterns displayed on the scope. Once the conditions of alignment are determined, the actual alignment of the set poses few complications. Start by connecting the scope and sweep generator (as shown in Fig. 1. Prepare the scope (connected across the video detector load resistor) by adjusting its brilliance, focus and centering controls. Make certain its built-in sweep oscillator is switched off, as the voltage required for horizontal trace is obtained from the sweep generator. With sweep generator's deviation dial set for 8 mc, adjust the horizontal gain of the scope until the trace line barely extends to the C-R tube limits. The r.f. cable from the generator can be connected to an ungrounded shield slipped over the mixer tube. With the vertical gain of the scope turned up, tune the generator over the i.f. range until a response curve appears and is centered on the scope screen.

The response curve we first get will probably be hard to interpret. It may appear like any of those shown in Fig. 2. Our first job then is to adjust the instruments (not the receiver) until the curve assumes the proper proportions so we can determine the set's alignment.

Using Fig. 2-a as our standard, note its symmetrical shape and how both sides slope gradually to the base line. Depending on the particular scope and receiver, the curve may be inverted. Fig. 2-b indicates excessive vertical gain, so reduce the vertical gain on the scope or the r.f. output from the generator. Fig. 2-c indicates insufficient gain. Figs. 2-d and 2-e show the result of the sweep generator being slightly off frequency in either direction. If it is off frequency by a greater amount,

# TV ALIGNMENT

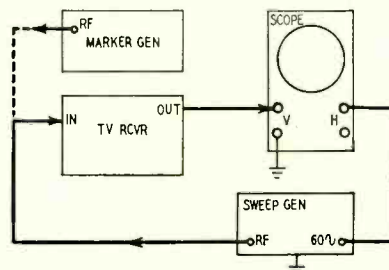

Fig. 1—Basic test equipment setup for aligning a television receiver.

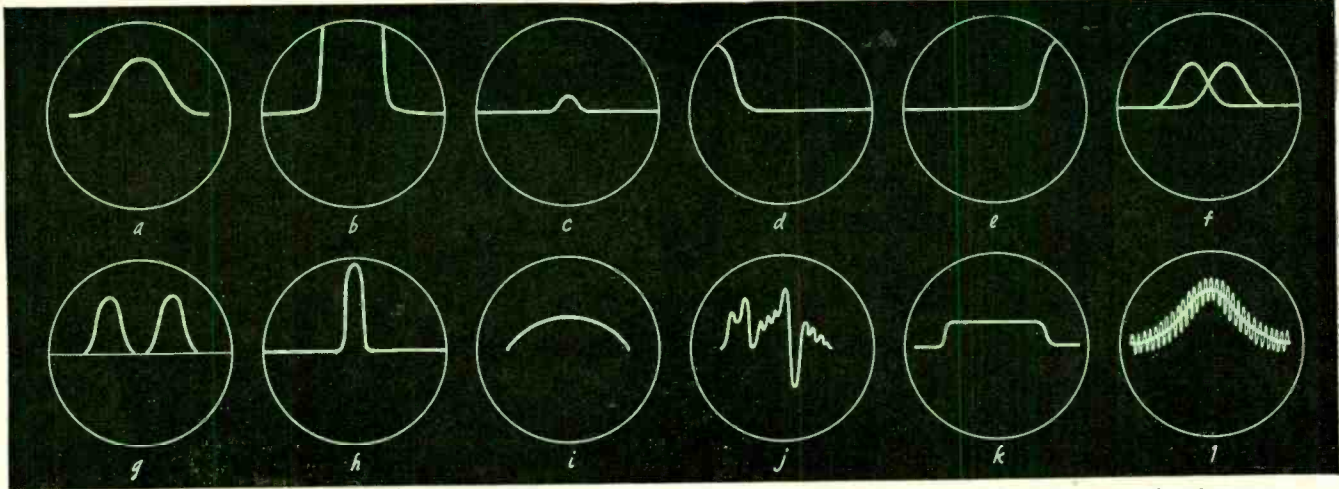

Fig. 2—A group of assorted response curves, as seen on the scope. Their interpretation is given in the text.

we would have only a horizontal line. Where the scope trace and the generator are not in step, we may have patterns as shown in Figs. 2-f and 2-g. For this we adjust the phasing control on the generator until the forward and return traces overlap. Where the curve has a narrow appearance as in Fig. 2-h, reduce the amount of sweep with the generator deviation control. Fig. 2-i shows the reverse condition — too little sweep is being used. Fig. 2-j is the result of external pickup from interference — try switching to an unused channel or disabling the tuner oscillator by grounding its grid or removing the oscillator tube if a separate one is used. Fig. 2-k is an indication of overloading due to an excessive generator signal or insufficient a.g.c. bias on the set. Fig. 2-l shows the presence of oscillations which may disappear as alignment progresses. Try varying the a.g.c. bias or backing off on the contrast control.

Once we have the overall response curve, we can identify various spots on it with a marker signal. The marker generator may also be coupled to the mixer tube, or its hot and ground leads may be connected between any two chassis points at both extremes of the i.f. strip. This is a good method as the r.f. voltage developed across the chassis resistance is simultaneously injected into all stages without any coupling problems. With the modulation turned off and the generator set for maximum output, tune to the same frequency as the setting on the sweep generator. As the marker hits the curve frequencies, the response will become distorted or completely obscured. Reduce the marker output until the pip indication is barely discernible. If the marker cannot be reduced enough to prevent curve distortion, try looser generator coupling or reduce the vertical gain of the scope. Where the marker is too weak to be seen, try tighter coupling or increase the scope gain, which must be compensated for by attenuating the sweep generator to keep the response within the limits of the C-R tube.

The next step is to determine the

high- and low-frequency sides of the curve. Here again it may be one way or the other, depending on what scope and receiver are used. The procedure is simply to tune the marker generator, noting which way the marker pip moves on the curve and comparing it with the frequency markings on the dial. After obtaining correct pix and sound i.f. carrier frequencies from manufacturer's specs, tune the marker generator alternately to them and note where the pips fall on the response curve.

Also check bandwidth between the two markers situated on both slopes at the 50% level. Actual bandwidth depends on the particular receiver (Fig. 3), the better-quality sets using nearly 4 mc. On split-carrier sets, the sound marker is positioned where the curve meets the base line. For intercarrier sets, the sound marker should ride up the slope to about the 10% level.

As the swept frequency of the generator travels through the set, it is influenced by the resonant condition of each i.f. stage. For example, suppose the receiver i.f. coils are tuned to 22, 24 and 26 mc, respectively. As the FM generator sweeps through this range, a high resonant voltage will be developed at these frequencies, and very little in between. The varying signal voltage is fed to the vertical input of the scope. The horizontal trace is synchronized with the modulation of the generator, and the scope curve will show amplitude variations as the frequency changes.

The sweep generator in this case would be tuned to 24 mc, the center frequency. If the sweep is set for 8 mc, the frequency changes will vary from 20 to 28 mc, the amount necessary for observation of the entire response curve. With a sweep of 4 mc we would see only the top portion of the curve. Too much sweep will show more than the curve frequencies, giving the curve a narrowed appearance. A marker signal injected into the i.f. strip produces a pip for identification of frequency points on the response curve.

Where misplaced markers and improper bandwidth indicate our set requires alignment, start by moving the response curve to its proper center fre-

quency. This is done by tuning all i.f. slugs either in or out until the curve is centered on the scope. Now inject the proper marker frequency for either the sound or pix i.f. carrier, regardless of where it falls on the curve. Experimentally adjust the coil slugs slightly to position the marker correctly. Then position the other marker. Do not overtune any coil; return the slug to its original setting if it does not produce the desired effect. Due to interaction, it may be necessary to shift from one marker to the other for optimum alignment.

Some receivers can best be aligned stage by stage. The procedure described applies except for instrument connections. The generator is fed to the grid of the tube preceding the coil being tuned. The scope is connected to the plate of the following tube, using a high-frequency probe. For this method the manufacturer usually provides a series of curves showing general appearance and marker locations for each stage.

### Sound i.f. alignment

Trouble symptoms indicating misalignment of sound i.f. stages are: complete absence of sound on all channels, weak or distorted sound, excessive sync buzz, and poor pix-sound tracking. Although there are several methods of aligning this section, the one discussed is the simplest and fastest.

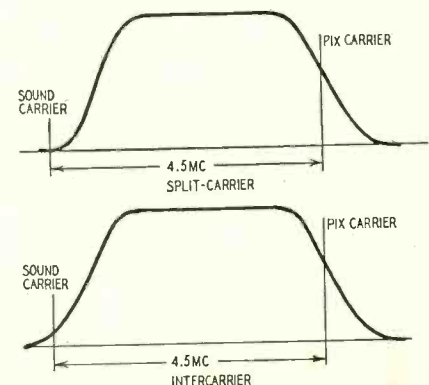
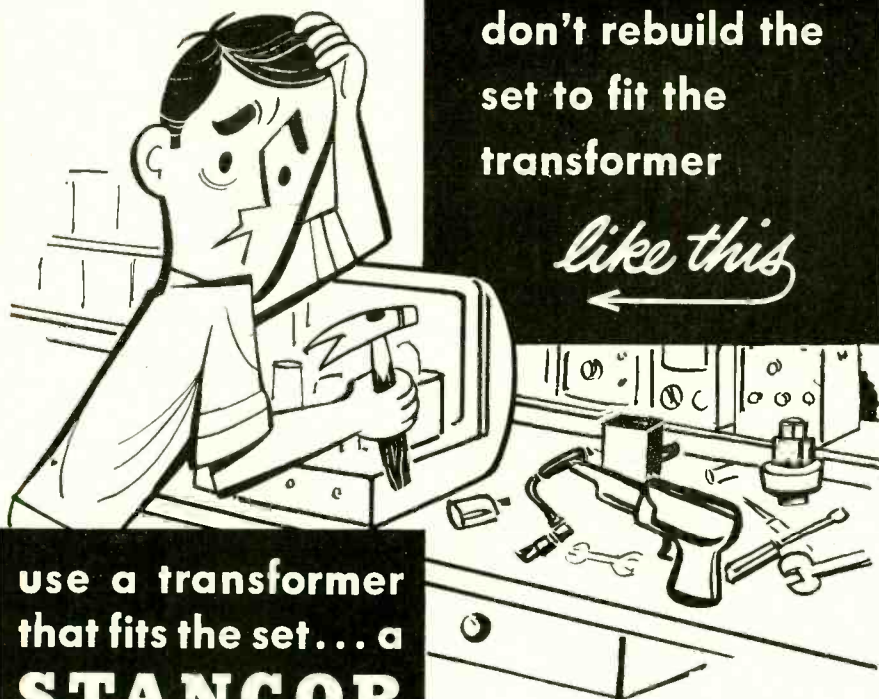

Fig. 3—Typical curves for intercarrier and split-carrier TV receivers.



don't rebuild the set to fit the transformer

*like this*

use a transformer that fits the set... a **STANCOR** *verified* exact replacement **TRANSFORMER**

**FREE** STANCOR TV Transformer Catalog and Replacement Guide listing replacement data on virtually all TV sets in use today, with hundreds of **VERIFIED** exact replacement applications.

When you install a STANCOR exact replacement TV transformer, all you'll need is a soldering iron and a screwdriver, and perhaps a wire cutter . . . because STANCOR transformers are **VERIFIED** exact replacements . . . designed from the original manufacturers specifications and tested by actual installation and operation in the recommended chassis.

EXPORT SALES:  
Roburn Agencies, Inc.  
431 Greenwich Street  
New York 13, N. Y.



**CHICAGO STANDARD TRANSFORMER CORPORATION**

3592 Elston Avenue • Chicago 18, Illinois

**TELEVISION**

Feed a modulated signal to the grid of the tube preceding the point of sound takeoff. Connect a v.t.v.m., set at a low a.c. range, to the grid or plate of any a.f. tube. With the generator tuned to the proper i.f., peak all sound i.f. slugs for maximum meter reading. Repeat this a second time with the generator output greatly reduced. With the antenna connected, tune in a signal and adjust the sound discriminator transformer for minimum sync buzz. Where misalignment is so extreme that the signal will not get through, adjust each stage separately by feeding the generator to the grid of each tube, working back from discriminator to sound takeoff.

Where pix-sound tracking is poor and a generator is not available (as on house calls), the following procedure is effective. Set the fine tuner for best picture contrast, adjusting it slightly until the "edge" of the sound is heard. Peak all sound i.f. slugs for maximum volume. Repeat this until the picture and sound are coincident for one setting of the fine tuner. Finish by carefully adjusting the discriminator transformer to clear up the distortion and sync buzz.

**Tuner alignment**

Symptoms that indicate need for tuner alignment are: no picture, sound or both on one or more channels; weak, snowy picture on one or more channels; weak, distorted sound on several channels. All weak tuner tubes should be replaced before attempting alignment.

Most tuners have one or more r.f.-mixer adjustments. The oscillator may have as many as three frequency controls: a master oscillator adjustment, individual channel slugs accessible from the front and fine tuning. Although they all accomplish the same purpose, each has its own particular use. The master adjustment can be used after the replacement of the oscillator tube or where one or more channels cannot be tuned by individual channel slugs. The fine tuner is used by the set owner to compensate for oscillator drift.

For overall tuner alignment, set the fine tuning control to mid-position. Adjust the oscillator slugs to bring in picture and sound of each channel. Remove the antenna and connect an r.f. signal generator to the antenna terminals via a suitable matching network. For a resonance indication use a v.t.v.m. across the video detector load.

Set the receiver on a given channel and tune the generator to the pix carrier. Adjust the r.f. slugs in the tuner for maximum meter reading. Tune the generator to the sound carrier and adjust the mixer slugs for greatest deflection. If the two readings differ by more than 25%, alternately adjust each until they are nearly equal. Air-check reception on all channels and, if necessary, make a compromise touch-up in favor of the weakest one. **END**

**NEW! For the First Time!**  
**CHECK CAPACITORS UNDER WORKING CONDITIONS!**

**TEST CONDENSERS IN THE SET!**



**CAPACITEST**

Quickly, Accurately checks:

- PAPER, MICA, CERAMIC CAPACITORS
- ELECTROLYTICS
- CONTINUITY
- AC/DC VOLTAGES
- FLASHBULBS

SATISFACTION GUARANTEED OR RETURN WITHIN TEN DAYS FOR REFUND

**\$9.95** postpaid Dir. Net complete, ready for operation

**NOT A KIT**

**FREE** Special Introductory Offer for limited time only: Set of test leads Free with each CAPACITEST.

Order direct from manufacturer - include \$3 deposit with C.O.D.'s. Save PP & COD fees, send \$9.95 & we'll pay Postage.

ment is a new, compact checker that does a giant job to save you time and money. It will check condensers at 150 Volts, which is approximately the working voltage in a radio or TV set. Meters will not give this type of check since the applied voltage is 20 Volts or less. Avoid call-backs by using CAPACITEST. Accurately, quickly, it shows open, shorted, or intermittent capacitors and leaky electrolytics. Compact: 4"x4"x2"-lightweight, for bench or tool kit.

**BARJAY The Barjay Co.** 145 West 40 Street New York 18, N.Y.



# new!

## Simpson 7" COLORSCOPE



**MODEL 458**

**\$229<sup>95</sup>** complete with shielded input cable and manual

### 100% response at 3.58 mc colorburst!

#### DUAL BANDWIDTH—NARROW OR WIDE

Compare the new Simpson Colorscope Model 458 with any oscilloscope on the market. It is an advanced, seven-inch, high-gain, wide-band scope especially designed for color-TV service. (Ideal for black and white, too.) A big feature of the Model 458 is its *flat* frequency response—within 1 db to 4.5 mc! With its accessory probes, Model 458 can do more color-TV testing jobs than any scope in its price range.

#### ADDITIONAL FEATURES

- Dual bandwidth provides extra testing versatility.
- Properly compensated wide band vertical amplifier stages.
- High sensitivity and very good transient response.
- Compensated step attenuator.
- Vernier vertical attenuator for *continuous control* of the signal voltage.
- CRT balanced deflection.
- Excellent square wave response.
- Very small loading of circuit being checked.

- "Tilt" and "Overshoot" carefully checked and minimized.
- Very stable sweep and synchronizing circuits.

#### ACCESSORY PROBES

- Voltage Doubler, No. 740 . . \$10.95
- Low Capacitance (input impedance of 10 megohms shunted by only 14 mmf), No. 741 . . \$9.95
- 100:1 Voltage Divider, No. 742 . . . . . \$9.95
- Direct-Resistive Dual Purpose, No. 743 . . . . . \$9.95

See Your Electronics Parts Distributor, or write

**SIMPSON ELECTRIC COMPANY**  
WORLD'S LARGEST MANUFACTURER OF ELECTRONIC TEST EQUIPMENT  
5200 W. Kinzie St., Chicago 44, Illinois  
Phone: ESTebrook 9-1121  
In Canada: Bach-Simpson Ltd., London, Ontario

#### SPECIFICATIONS

**VERTICAL AMPLIFIER FREQUENCY RESPONSE**—Wide band position: Flat within  $\pm 1$  db from 20 c/sec to 4.5 mc/sec; flat within  $\pm 2$  db from 10 c/sec to 5.0 mc/sec.

Narrow band position: Flat within  $\pm 1$  db from 20 c/sec to 200 kc/sec; flat within  $\pm 2$  db from 10 c/sec to 300 kc/sec.

**RISE TIME**—Less than 0.05 microsecond (wide band position).

**VERTICAL DEFLECTION SENSITIVITY**—Wide band: 40 mv R.M.S./inch minimum. Narrow band: 15 mv R.M.S./inch minimum.

**HORIZONTAL AMPLIFIER FREQUENCY RESPONSE**—Flat within  $\pm 1$  db from 20 cycles/sec to 200 kc/sec.

**HORIZONTAL DEFLECTION SENSITIVITY**—Horizontal input "Hi", 115 millivolts R.M.S./inch minimum. Horizontal input "Low", 1.4 volts R.M.S./inch minimum.

**VERTICAL INPUT IMPEDANCE**—3.3 Megohms shunted by 20 mmf.

**HORIZONTAL INPUT IMPEDANCE** 1.1 Meg.

**LINEAR SWEEP OSCILLATOR**—Saw tooth wave from 14 cycles/sec to 250 kc/sec. Sixty-cycle sine wave also provided.

**INPUT CALIBRATION**—18 Volt P-P test voltage available on panel.

**INTENSITY MODULATION**—Provision for internal, external and 60 cycles.

# TROUBLESHOOTING

By JAMES A. McROBERTS

# THE VIDEO DETECTOR

SEVERAL troubles can arise from defective video detector operation. Some of them are not too evident. For example, good sound with poor or no picture and sync can be due to the video detector. (This article is based on intercarrier sets.) Furthermore, placing the crystal detector in the last i.f. can have made both its testing and replacement difficult.

The video detector performs two functions: as an AM detector it rectifies and filters the modulated i.f. input to deliver a composite video signal to the video amplifier. As a mixer it heterodynes the AM picture carrier with the FM sound carrier to produce the 4.5-mc intercarrier sound. Fig. 1 shows the course of the signals.

In the majority of modern sets, the output of the picture detector must yield a signal greater than 1 volt to peak to produce a usable picture; a good picture requires 3 or more volts. If the video detector and preceding sections are performing satisfactorily, we can measure these voltages at the output of the second detector or its equivalent, the video amplifier input. We can select a weak station to see if more than the minimum of 1 volt peak to peak is

present and also to see if the output on a strong signal is 3 to 5 volts peak to peak. The sound i.f. will be present if both picture and sound signals are sufficiently strong. A very weak picture signal will heterodyne with the sound signal to procure fair sound.

### Testing procedure

In troubleshooting, check with an oscilloscope or voltmeter at the video detector load to determine whether the output is satisfactory for the station tuned in. If so, the video detector is O.K. If not, the *input* to the video detector must be checked to see if the signal is satisfactory there. If it is, the trouble lies in the video detector or its circuitry.

The video detector may be a tube such as half a 6AL5. A circuit of this type is used in the Emerson chassis 120168D (Fig. 2). Typical modern crystal detector usage is shown in the schematic of the RCA chassis KCS81-B (Fig. 3); the crystal is in the last i.f. can. The input to the video detector is modulated i.f. The most accessible place to test is the plate of the last i.f. amplifier tube. Check here with a demodulator or peak-to-peak probe with a voltmeter.

To check the output of a video detector, connect an oscilloscope across the detector load resistor as indicated in Figs. 2 and 3. The detector load resistor may be easily identified in other circuits since its value is around 3,000 to 5,000 ohms.

The oscilloscope reads peak-to-peak values. Lacking a scope, a voltmeter may be used. Connect it across the detector load and it will read the average of the peak value of the signal. This is about one-third the peak-to-peak value. When using a voltmeter, switch the station to an unused channel to see if the measurement is really a signal or something else such as hum. Also note on an unused channel the reading caused by noise plus contact potential—the read-

ing on a signal will be increased by the contact potential. A weak-station voltage of over ¼ volt above contact potential is required.

If proper readings on a voltmeter or scope are not obtained, test the output of the last i.f. tube or the input to the video detector. Naturally, in the case of a tube rectifier, the tube should be replaced before making this test.

The oscilloscope should be fitted with a demodulator type probe to view the signal at the output of the last i.f. stage. Commercial demodulator probes are satisfactory, although I prefer to change the values to those shown in Fig. 4 which more closely resemble a second or video detector in their action. Note the low load resistance of 4,700 ohms which approximates the video detector load. The 5-μmf blocking capacitor need not be low; up to 100 μmf is good if the unit is used with an isolating resistor such as the 2,000-ohm unit shown in Fig. 4.

Fig. 5 is a photograph of a modified commercial probe with the isolation resistor attached to the probe end. The end lead of the resistor connecting to the circuit should be as short as is practical and may have a small hook to provide good contact with a lead to a socket terminal. The ground lead which leaves the case (also grounded) is close to the probe tip, placing the 10,000-ohm shunting resistor (Fig. 4) very close to ground. The ground lead should be attached to a ground point near the tube under measurement, and not just any handy place. The center contact of a tube socket is a convenient place to connect the probe ground. The ground lead should be stranded and relatively short.

With a probe such as described above, hook the probe tip to the plate of last i.f. tube and measure the scope indi-

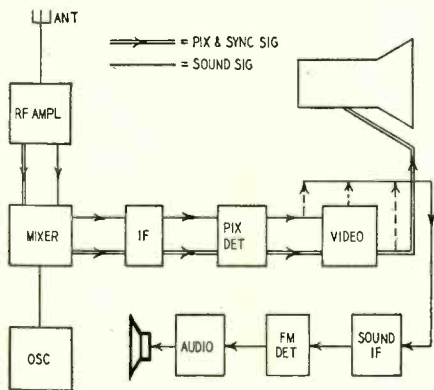

Fig. 1—Path of the audio and video signals in an intercarrier receiver.

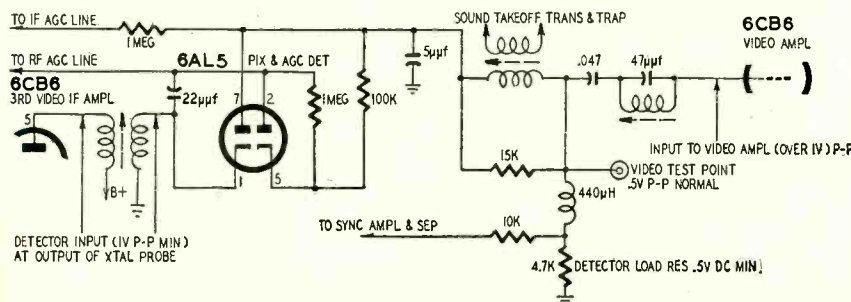

Fig. 2—Schematic diagram of the video detector in Emerson chassis 120168-D.

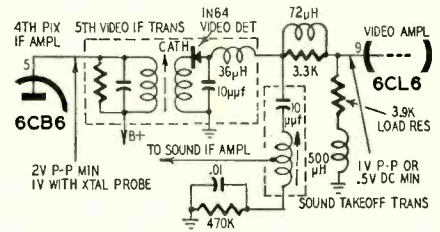

Fig. 3—Schematic diagram of the video detector circuit in RCA chassis KCS81-B.

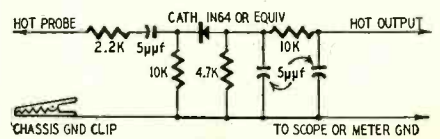

Fig. 4—A demodulator probe circuit.

# fabulous

## IS THE ONLY WORD TO DESCRIBE THEM!

*fabulous in*

- QUALITY
- PRICE
- RESPONSE
- PERFORMANCE

*fabulous in*

- SALES VALUE
- SALES VOLUME



HI FREQUENCY  
MODEL GT5C

Fabulous is the only word that can be applied to Utah's new series of speakers.

When you see how quickly and easily they will sell — because of their beauty and quality, their range, response and over-all perfection of performance — their unbelievable low price for a quality speaker — you too will call them fabulous.

You can start today to spark-up your speaker sales with this sensational new speaker line — the Utah "Fabulous G" Series.

Sell them for single or multiple speaker installations . . . for the beginning Hi Fi enthusiast . . . for replacement to improve response in present TV, AM or FM receivers . . . for additional speakers in Hi Fi systems or bi-aural applications . . .

Sell them for customer satisfaction.

Because of their sale VALUE — their sales VOLUME can be sensational for you.

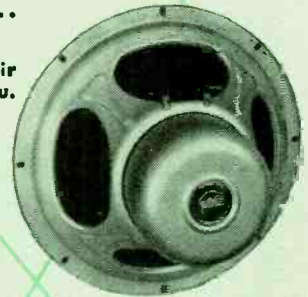

WOOFER  
MODEL G15P

*utah's*

**NEW FABULOUS "G"  
SERIES OF SOUND  
REPRODUCERS . . . .**

**8  
NEW SPEAKER  
MODELS WITH A  
FREQUENCY  
RESPONSE FOR  
EVERY  
APPLICATION**

- Mid-Range
- Extended Range
- Tweeter
- Woofer
- Coaxial

**NOTE THESE  
"SELLABLE"  
"FABULOUS G"  
SERIES FEATURES**

**EXCEPTIONALLY FINE  
FREQUENCY RESPONSE**

**BEAUTY — SEA-FROTH  
GREEN FINISH OVER  
HEAVY CADMIUM  
PLATING**

**HEAVY  
ALNICO V MAGNETS**

**8 OHMS VOICE  
COIL IMPEDANCE**

**HEAVY, SEAMLESS,  
MOLDED CONES  
CEMENTED AND  
MOISTURE RESISTANT**

**CONVENIENT SOLDER-  
LESS TERMINALS**

**EXACTING "DYNAMIC  
RANGE" QUALITY  
CONTROL TESTING**

**ECONOMY PRICED THE  
BEST BUY IN HI FI**

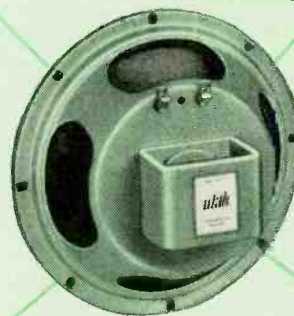

MID RANGE  
MODEL GM8J

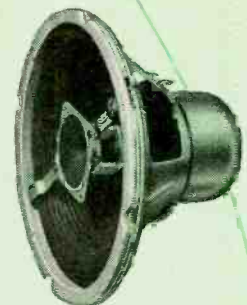

COAXIAL  
MODEL G12J3

Export Dept. Rocke International Corp. N. Y. C.



**RADIO PRODUCTS CO., INC.**

HUNTINGTON, INDIANA

# THIS professional TRAINING IS THE KIND THAT Really Pays Off!

... and it costs only a fraction of what you might expect to pay!

**FIX ANY RADIO OR TV SET EVER MADE...easier...better...faster**

Backed by the how-to-do-it methods so clearly explained in this one big 822-page book, you'll be prepared for fast, accurate service on any radio or television receiver ever made.

Radio & Television TROUBLESHOOTING AND REPAIR by Ghirardi & Johnson is far and away the world's most modern, easily understood guide. Step by step, it takes you through each service procedure... from locating troubles with less testing to repairing them promptly by fully-approved professional methods... the kind that enable you to handle tough jobs as slick as you now do the easy ones.

**COMPLETE SERVICE TRAINING**

For beginners, this giant book is a complete service training course. For experienced servicemen, it is a quick, easy way to "brush up" on specific jobs; to

develop better methods and shortcuts and to find fast answers to tough jobs.

Here are just a few of the subjects covered: Components and Their Troubles; Basic Troubleshooting Methods; "Static" and "Dynamic" Testing; Practical Troubleshooting Tips and Ideas; AC/DC, 3-way Portable and Battery Set Troubleshooting Problems; Servicing Communications Receivers; a Complete Guide to Television Service: AM, FM, and TV Realignment Made Easy; Resistor, Capacitor, Inductor and Transformer Problems; Servicing Tuning, Selector and Switching Mechanism; Loudspeaker; Servicing Recorders and Record-playing Equipment... and dozens more. 417 illustrations. Read TROUBLESHOOTING AND REPAIR for 10 days AT OUR RISK!

Price only \$6.75 (or see money-saving combination offer.)

**LEARN BASIC CIRCUITS FULLY... and watch service "headaches" disappear**

It's amazing how much easier and faster you can repair radios, television sets and even industrial electronic equipment when you know all about circuits and what makes each one "tick."

You locate troubles in a jiffy because you know what to look for and where. You make repairs lots faster, better and more profitably!

Actually, there are only a comparatively few BASIC circuits in modern equipment. Radio & Television RECEIVER CIRCUITRY AND OPERATION by Ghirardi and Johnson gives you a complete understanding of these as well as their variations. It teaches you to recognize them... to understand their peculiarities and likely "troubleshooting" spots... and shows how to eliminate useless testing and guesswork in making repairs.

**LEARN MORE — EARN MORE!**

Throughout, this 669-page book with its 417 clear illustrations gives you the kind of above-average professional training that fits you for the better, big pay jobs in either servicing or general electronics. Covers all circuits in modern TV and radio receivers, amplifiers, phono-pickups, record players, etc. Price only \$6.50... or see money-saving offer in coupon. Examine it 10 days at our risk!

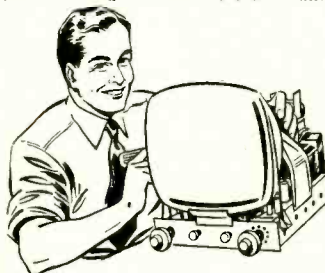

**THESE FAMOUS BOOKS REALLY SHOW YOU HOW!**

More radio-TV technicians have trained from Ghirardi books than any others of their kind! Almost 1300 pages and over 800 pictures and diagrams in these two new books explain things so clearly it's next to impossible for you to go wrong. Each book is strictly up-to-the-minute... NOT a re-hash of old, out-moded material.

RINEHART BOOKS ARE SOLD BY LEADING BOOK STORES



**TELEVISION**

caution. The reading will be somewhat less than the reading at the output of the video detector. Voltage-divider action of the isolation resistor and the shunt impedance across the input to the probe's crystal detector will cause about a 10% loss; the amount may be checked on a set in good operating condition.

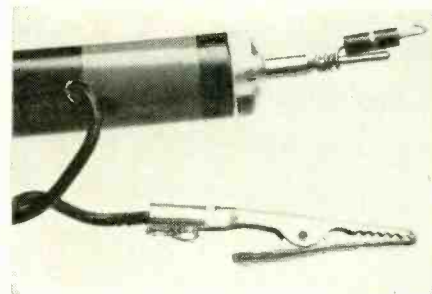

Fig. 5—Typical commercial probe.

There will be some detuning, minimized by the isolating resistor. Usually, a reading of more than two-thirds of that expected at the output of the video detector can be considered satisfactory.

If no scope is available, the voltmeter may be connected across the output of the probe. The readings will be about one-third those obtained with the scope. When using a voltmeter, switch to an unused channel to determine whether the indicated reading is due to a signal or to hum or some other voltage.

**Isolating the trouble**

When it has been determined that the trouble is in the video detector, check for open resistors and coils with an ohmmeter. Substituting a tube rectifier will reveal a bad diode. Substitution or check on a capacitance meter will test the capacitors. The small 5-10- $\mu$ f filter capacitor may be disconnected for testing since the signal will come through with it out of the circuit and this will eliminate the possibility of its being short-circuited. The capacitor may be shunted if it is suspected of being open-circuited.

The i.f. tuning in the detector circuit may be off; it can be checked by turning the slug adjusting screw while monitoring the output or the picture. Make a mark in line with the adjustment screw slot on the chassis prior to turning this screw so that you can return to the same point if there is no change. An ohmmeter check will reveal a short-circuited crystal detector.

Crystal detectors have a bad habit of changing their forward resistance. The forward resistance of a good crystal is about 75-100 ohms and the back resistance 150,000 ohms or more, resulting in a ratio of 2,000 to 1 or so. To obtain a good video signal, the ratio must exceed about 200 to 1. To heterodyne sound, a ratio of 10 to 1 will yield a good signal. This accounts for the phenomenon of good sound with no picture. In such a case, after making the tests mentioned, check the crystal with an ohmmeter or, better yet, replace it.

**FREE EXAMINATION...easy terms!**

Dept. RE-125, RINEHART & CO., INC.  
232 Madison Ave., New York 16, N. Y.

Send books indicated for FREE EXAMINATION. In 10 days, I will either remit price indicated plus postage or return books postpaid and owe you nothing.

Radio & TV TROUBLESHOOTING AND REPAIR (Price \$6.75)     Radio & TV CIRCUITRY AND OPERATION (Price \$6.50)

COMBINATION OFFER... Both books only \$12.00. (Price separately \$13.25... you save \$1.25)

(Combination offer is payable at rate of \$3 [plus postage] after 10 days if you decide to keep books, and \$3 a month thereafter until \$12 has been paid.)

Name .....

Address .....

City, Zone, State.....

OUTSIDE U.S.A. . . . \$7.25 for TROUBLESHOOTING & REPAIR; \$7.00 for CIRCUITRY & OPERATION; \$13.00 for both books; Cash with order, but money refunded if you return books in 10 days.

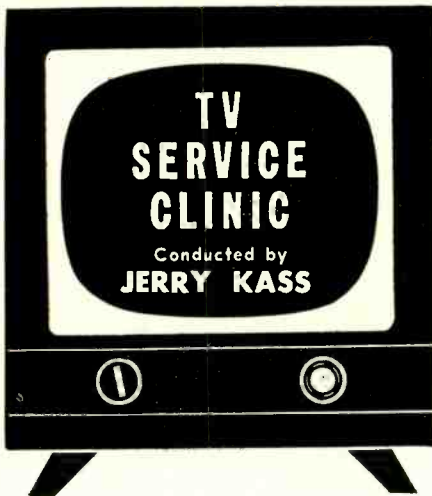

PICTURE quality, so easily degraded by even the slightest of interfering signals, is carefully guarded in most TV sets by a series of traps. Designed to pass 6-mc wide channels, the low-Q front-end r.f. circuits have a broad sloping frequency response (Fig. 1) that permits passage of adjacent-channel sound and video signals causing sound bars and beat notes.

With channel 3, for example, occupying 60 to 66 mc, its video carrier at 61.25 mc and sound carrier at 65.75 mc fall extremely close to the sound carrier of the lower adjacent channel (59.75

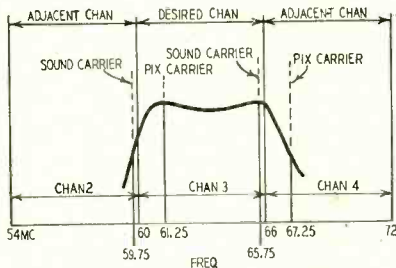

Fig. 1—Broad response of TV tuner admits adjacent-channel interference.

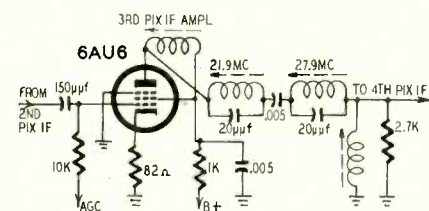

Fig. 2—The parallel-tuned traps are inserted in series in the signal path.

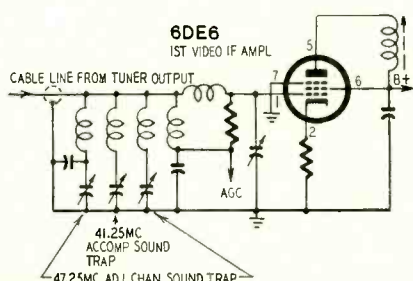

Fig. 3—Series-tuned traps shunt signal path and attenuate interference.

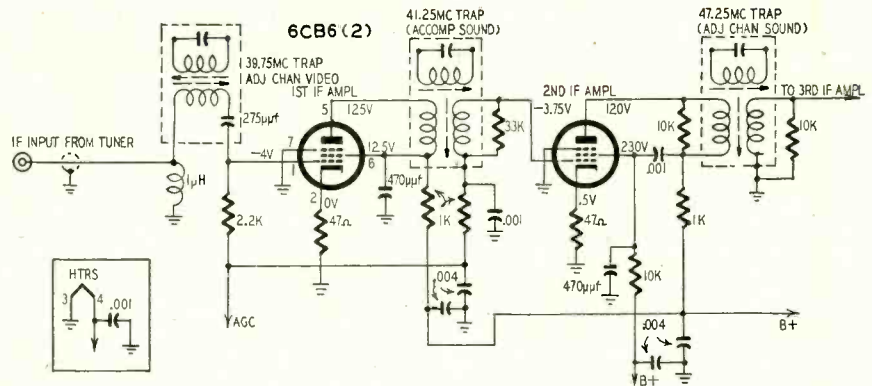

Fig. 4—Absorption type i.f. traps in Stromberg Carlson models K-KH21-22.

mc) and the video carrier of the higher adjacent channel (67.25 mc). Thus an i.f. amplifier having its video i.f. at 25.75 mc and sound i.f. at 21.25 mc would find its tuner passing an adjacent-channel video signal of 19.75 mc and an adjacent-channel audio signal of 27.25 mc.

Fortunately, TV frequency allocations are such that adjacent channels are not usually found in the same area. A good example of this are the New York City stations: channels 2, 4, 5, 7, 9, 11, 13. It would appear that channels 4 and 5 might interfere with each other; however channel 4 at 66-72 mc and channel 5 at 76-82 mc have a 4-mc buffer between them. But with stations continually increasing their power, more and more areas are receiving good signals from adjacent channels.

Thus it remains for the high selectivity of the i.f. amplifier to remove adjacent-channel interference. In some sets, notably RCA 1953-55 models, selectivity adequate for interference rejection is provided by i.f. amplifier design and overall alignment. In others the additional selectivity required for full interference suppression is provided by a series of traps. In this connection traps have an additional function of removing or attenuating the associated sound i.f. in video i.f. amplifiers. In intercarrier sets the sound i.f. is reduced for optimum video detector operation; in split-carrier sets traps remove any audio i.f. signal remaining after the sound takeoff. These traps are tuned to the sound i.f. of the receiver.

Traps

A commonly used trap consists of a parallel L-C circuit tuned to the frequency to be rejected and connected in series with the signal path. Like all traps it is sharply tuned to reject a very narrow band of frequencies. At its resonant frequency the L-C circuit offers maximum impedance. At frequencies above and below resonance its impedance decreases rapidly and signals are passed with very little attenuation. Fig. 2 shows two series type traps used between the third and fourth video i.f. stages in the Stromberg-Carlson TS-

125. These traps are tuned to reduce the associated sound (21.9 mc) and adjacent-channel sound (27.9 mc).

Another common type is the parallel trap, a series-resonant L-C network connected across the video i.f. amplifier. At its resonant frequency, the capacitive and inductive reactances of the trap are equal and the circuit appears as a short circuit to the unwanted signals. At any frequency other than the resonant one the impedance of the series circuit increases rapidly and becomes an input load impedance for the following stage. As in the series wavetrap, the selectivity of the circuit depends upon the Q—the higher the Q, the more selectivity.

Fig. 3 shows parallel traps used in the Philco chassis TV-301W. The grid circuit of the first i.f. contains two adjacent-channel sound traps at 47.25 mc. These are very sharply tuned to prevent the interfering signals from entering the i.f. amplifier. The 41.25-mc accompanying sound trap attenuates the signal for the proper video i.f. to sound i.f. ratio.

A bit more interesting is the absorption trap, perhaps the most widely used rejection circuit. Like the other traps, it consists of an L-C circuit (see Fig. 4) inductively coupled to the plate load coil of an i.f. amplifier. Operation is simple. The plate circuit receives all signals including those to be rejected. Energy from all signals is induced into the absorption circuit. However, at one frequency—trap circuit resonance—a large current flow takes place in the trap circuit. This reflects impedance into the primary, lowering the Q and gain of the primary circuit, reducing the voltage developed across the plate load impedance. Again, the sharpness of this rejection depends upon the Q of the wave trap. Fig. 4 shows a section of the i.f. amplifier in the Stromberg-Carlson K-KH21-22 in which extensive use is made of absorption traps. The network at 39.75 mc attenuates adjacent-channel video.

Another popular trap is found in the cathode circuit of i.f. amplifiers. The L-C circuit is directly in the cathode circuit. At the resonant frequency of the trap its impedance is very high,

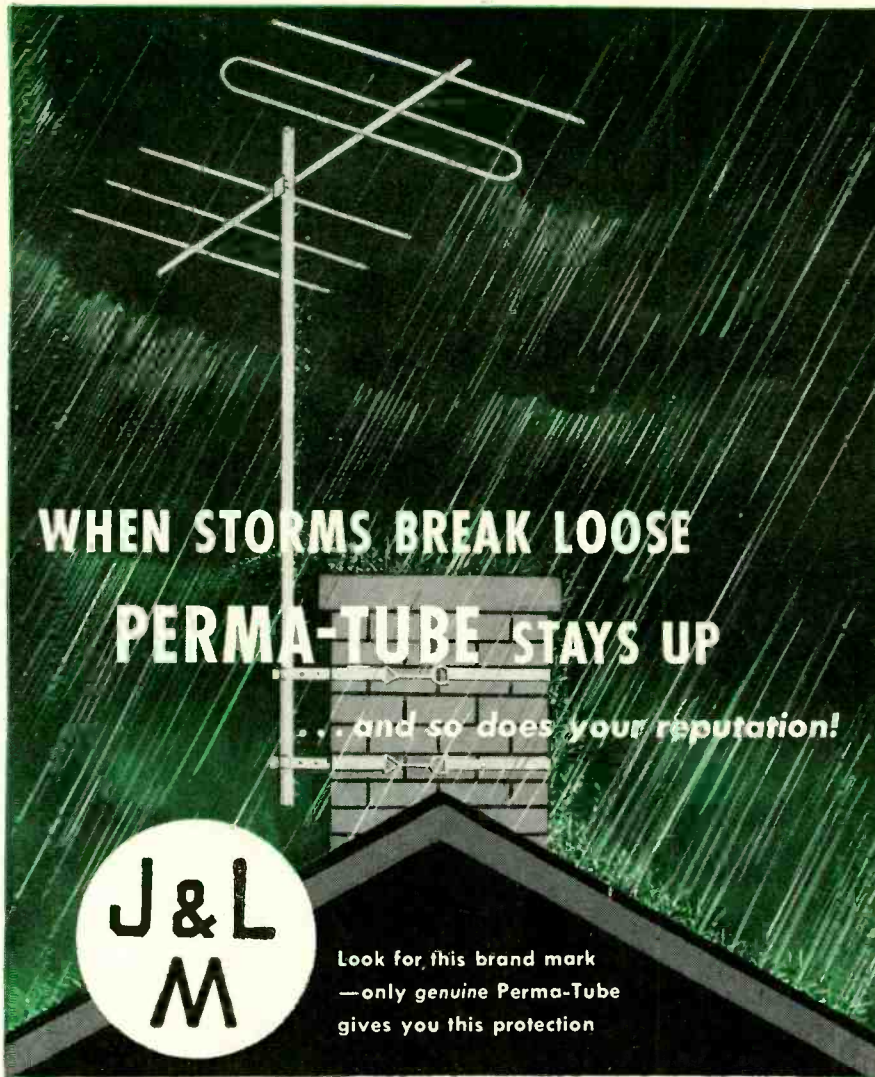

## Here's why . . . sturdy steel PERMA-TUBE is stronger than any other television mast

1. Its resistance to bending is *five times stronger* than structural aluminum.
2. Its resistance to deflection is *three times stronger* than structural aluminum.
3. Its resistance to destruction by wind-force is *twice as strong* as structural aluminum.

### ADDITIONAL REASONS FOR USING PERMA-TUBE EVERY TIME

PERMA-TUBE IS CORROSION PROOF . . . it's treated with vinsynite—then coated *inside and outside* with a metallic vinyl resin base.

PERMA-TUBE IS EASILY INSTALLED . . . it's the *only mast* with *both ends* of the joint machine fitted.

ONLY GENUINE PERMA-TUBE GIVES THIS PROTECTION AND SERVICE . . . look for this brand mark . . . accept no claims from substitute materials.



For complete information and scientific data write to: Jones & Laughlin Steel Corporation, Department 496, 3 Gateway Center, Pittsburgh 30, Pa.

**Jones & Laughlin**  
STEEL CORPORATION — Pittsburgh

## TELEVISION

producing a large degenerative (inverse feedback) voltage and reducing the gain of the amplifier at that frequency. At all other frequencies, only a small voltage appears and the cathode degeneration is very small.

The previously discussed absorption trap can also be applied to the cathode circuit. At the resonant frequency of the tank circuit, it will reflect a large impedance into the cathode circuit, reducing the gain of the amplifier at that

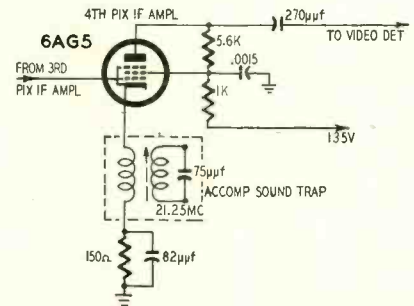

Fig. 5—A cathode absorption trap.

frequency. Fig. 5 shows such a circuit in the fourth video i.f. stage of the RCA 8TS30. This is an accompanying sound trap tuned to 21.25 mc.

### Alignment of Traps

Because they are sharply tuned circuits, resonant at one frequency, alignment is simple—so much so that considering their great effect on picture quality trap alignment should be a must.

Connect an AM signal generator (modulation off) covering the 20- or 40-mc i.f. range as the case may be, to the grid circuit of the mixer. Connect a v.t.v.m. across the load resistor of the video detector to act as an indicator. Then set the signal generator to each trap frequency in turn, adjusting that trap for minimum reading on the v.t.v.m. A somewhat more accurate setting can be made by using a scope in place of the v.t.v.m. and using a modulated i.f. signal.

Whenever available, use manufacturer's instructions for aligning a particular receiver. They will usually specify some amount of fixed bias to be applied to the a.g.c. bus and suggest a sequence of alignment. Traps are generally aligned before overall adjustment, and should be touched up afterward because of the slight interaction between the various tuned circuits.

### Excessive brightness

A Du Mont RA-112 chassis came in with an unusual set of troubles. The screen was very bright and, when the receiver was switched to FM or phono, it remained bright. Varying the brightness control had no effect. The picture could be seen, but it was very faint. I first suspected the switch since the picture tube should go dark on FM and phono. However, this component tested good. I did not check the picture tube because the raster lines were sharp and clear. There was one other inter-

BLACK AND WHITE TV  
COLOR TV

TRANSISTOR RADIOS  
FM RADIOS

AMPLIFIERS AND TUNERS  
AUTO RADIOS  
RECORD CHANGERS



# WHAT'S YOUR SERVICE PROBLEM?

## PHOTOFACT HELPS YOU SOLVE IT

**FASTER, EASIER, BETTER, MORE PROFITABLY!**

**THE WORLD'S  
FINEST SERVICE DATA**



**THESE GREAT FEATURES ARE EXCLUSIVE IN PHOTOFACT—THEY HELP YOU EARN MORE DAILY, HELP INSURE CUSTOMER SATISFACTION**

PHOTOFACT Service Data is the *only* service information based upon first-hand examination of the actual production-run receivers and equipment. It is authentic, uniform data developed through actual study and analysis by service engineers in the Howard W. Sams Laboratories. PHOTOFACT is the *only* data prepared from the practical point of view of the Service Technician. Thousands of Service Technicians use PHOTOFACT daily for time-saving, profit-boosting service operations. If you've never used PHOTOFACT, you've never realized your full earning power—you've never given such complete customer satisfaction. So get the proof for yourself. Try PHOTOFACT—use it on any job. Your Parts Distributor has the Folder Sets you need for any of the 17,000 TV and radio receivers, changers, recorders, etc., covered in PHOTOFACT. Once you use this great service, we know you'll want the complete PHOTOFACT Library.

**FREE Send for the PHOTOFACT CUMULATIVE INDEX IT'S VALUABLE!**

Send for it! Your guide to virtually any model ever to come into your shop; helps you locate the proper PHOTOFACT Folder you need to solve any service problem on any model. Once you have the make and chassis number, it takes just 60 seconds to find the applicable PHOTOFACT Folder. Send coupon now for your FREE copy of the valuable Cumulative Index to all the PHOTOFACT Folders you need.



**FREE**

- FULL SCHEMATIC COVERAGE**
1. Famous "Standard Notation" uniform symbols are used in every schematic.
  2. The same standard, uniform layout is used for each schematic.
  3. Diagrams are clear, large, easy to read, easy to handle.
  4. Wave forms are shown right on the TV schematics for quick analysis by 'scope.
  5. Voltages appear on the schematics for speedy voltage analysis.
  6. Transformer lead color-coding is indicated on the schematic.
  7. Transformer winding resistances appear on the schematic.
  8. Schematics are keyed to photos and parts lists.

- FULL PHOTOGRAPHIC COVERAGE**
9. Exclusive photo coverage of all chassis views is provided for each receiver.
  10. All parts are numbered and keyed to the schematic and parts lists.
  11. Photo coverage provides quicker parts identifications and location.

- ALIGNMENT INSTRUCTIONS**
12. Complete, detailed alignment data is standard and uniformly presented in all Folders.
  13. Alignment frequencies are shown on radio photos adjacent to adjustment number—adjustments are keyed to schematic and photos.

- TUBE PLACEMENT CHARTS**
14. Top and bottom views are shown. Top view is positioned as chassis would be viewed from back of cabinet.
  15. Blank pin or locating key on each tube is shown on placement chart.
  16. Tube charts include fuse location for quick service reference.

- TUBE FAILURE CHECK CHARTS**
17. Shows common trouble symptoms and indicates tubes generally responsible for such troubles.
  18. Series filament strings are schematically presented for quick reference.

- COMPLETE PARTS LISTS**
19. A complete and detailed parts list is given for each receiver.
  20. Proper replacement parts are listed, together with installation notes where required.
  21. All parts are keyed to the photos and schematics for quick reference.

- FIELD SERVICE NOTES**
22. Each Folder includes time-saving tips for servicing in the customer's home.
  23. Valuable hints are given for quick access to pertinent adjustments.
  24. Tips on safety glass removal and cleaning.

- TROUBLE-SHOOTING AIDS**
25. Includes advice for localizing commonly recurring troubles.
  26. Gives useful description of any new or unusual circuits employed in the receiver.
  27. Includes hints and advice for each specific chassis.

- OUTSTANDING GENERAL FEATURES**
28. Each and every PHOTOFACT Folder, regardless of receiver manufacturer, is presented in a standard, uniform layout.
  29. PHOTOFACT is a *current* service—you don't have to wait a year or longer for the data you need. PHOTOFACT keeps right up with receiver production.
  30. PHOTOFACT gives you complete coverage on TV, Radio, Amplifiers, Tuners, Phonos, Changers.
  31. PHOTOFACT maintains an inquiry service bureau for the benefit of its customers.

**FREE HOWARD W. SAM'S & CO., INC.**

Howard W. Sams & Co., Inc., Dept. 2-M5  
2201 E. 46th St., Indianapolis 5, Ind.

Send FREE Photofact Cumulative Index.

Name.....

Address.....

City.....Zone...State.....

**EASY-PAY PLAN TO FIT YOUR BUDGET**

Ask your PHOTOFACT Distributor... he'll show you how you can now own the PHOTOFACT Library through a unique Easy-Pay Plan that exactly fits your needs. Pays for itself as you EARN MORE.

**HELPS YOU EARN MORE DAILY**

# Plagued by Call Backs?

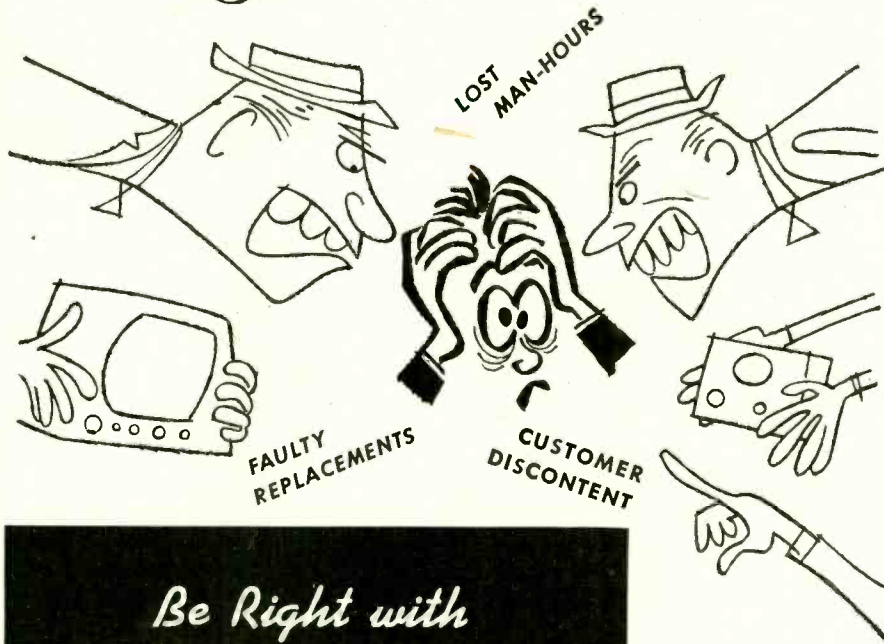

Be Right with  
**OHMITE®**  
DEPENDABLE REPLACEMENTS

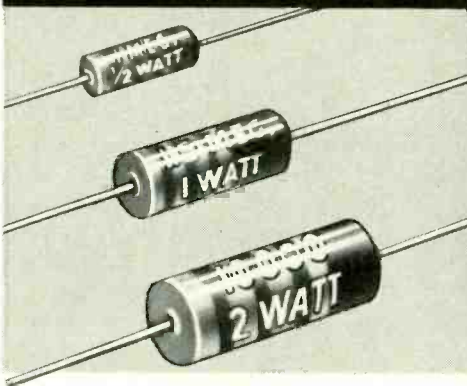

## Little Devil® COMPOSITION RESISTORS

meet all MIL-R-11A requirements... are completely sealed and insulated by molded plastic. Rated at 70C rather than 40C. Available in 1/2, 1, and 2-watt sizes in all standard RETMA values.

Other Ohmite Products available from your Electronics Parts Distributor...

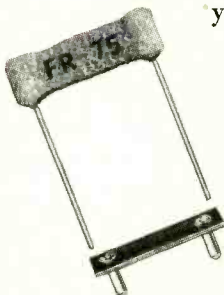

**FR-7.5 FUSE RESISTOR**  
for replacement in all television receivers.



**TYPE AB POTENTIOMETERS**  
Solid molded. Noise-free. Rated at 2-watts.



**BROWN DEVIL® RESISTORS**  
Vitreous enameled, in 5, 10, and 20-watt sizes.

**OHMITE®**

WRITE FOR STOCK CATALOG

OHMITE MANUFACTURING COMPANY  
3646 Howard St., Skokie, Ill.  
(Suburb of Chicago)

## TELEVISION

esting effect. When I removed the 6AL5 d.c. restorer (Fig. 4), the brightness level returned to normal and could be fully controlled by the brightness control.

This pretty much limited the trouble to the signal input circuit. However, I have been unable to come up with

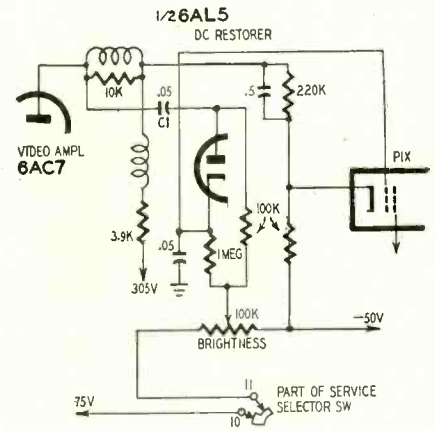

Fig. 6—Picture tube input circuit.

defective components. The 6AC7 video amplifier and the d.c. restorer tubes have been replaced. I would appreciate help on this problem.—A. B., Brooklyn, N. Y.

Since the raster remains bright on the FM and phono positions, there is probably an excessively high negative voltage on the cathode of the picture tube or a positive voltage on the grid. The significant clue is that you have normal control of brightness with the d.c. restorer removed. This eliminates cathode voltage trouble since the circuit between the -50-volt supply and the cathode is not affected by the action of the 6AL5. However, the grid circuit of the picture tube is connected to the 6AL5 cathode.

Thus, a leaky .05- $\mu$ f coupling capacitor (C1) between the video amplifier and the d.c. restorer would place a high d.c. potential on the grid and cause continuous brightness at all positions. Removing the 6AL5 breaks this circuit and restores normal brightness action.

### Horizontal jitter

A Tech-Master model 1930 came in with no horizontal sync and very critical vertical sync. Two capacitors and a new sync separator took care of the vertical troubles but the horizontal jitter remained. I believe I have disconnected and tested every part in the sync circuits and the horizontal a.f.c. circuit, and have substituted new tubes.

Tapping the 6AC7 horizontal oscillator control tube produces an exaggerated jitter. But tapping any other place or component has no effect. I have even gone so far as to resolder every connection in this circuit. I'm stuck and would appreciate any suggestions you might have.—D. L., Mount Pulaski, Ill.

Since you have made such an exten-



sive examination of the horizontal a.f.c. circuit, you have narrowed the possibility of trouble down to a very common defect in this chassis. In the low-voltage power supply (Fig. 7) there is a three-section bleeder resistor (R1 - R2 - R3) connected between ground and the negative supply. The lower resistor R1 is 12 ohms and frequently becomes intermittent, often changing in value. This section of the bleeder can be replaced by a 12-ohm 1-watt resistor.

The 2 volts negative fed from this point to the horizontal a.f.c. circuit is

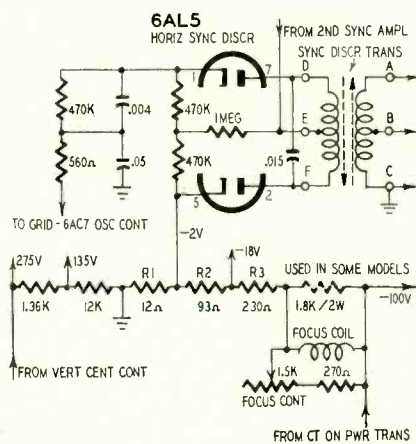

Fig. 7—Bleeder and a.f.c. circuits.

very critical. Anything below about -1.6 or more than -2.4 will almost always cause horizontal jitter. This point is often overlooked because, unless measured on a 5-volt range or so, ½-volt differences are usually not noticed.

**Split picture**

I recently replaced a horizontal output transformer in a Sentinel 1U-446 receiver with the equivalent Stancor unit. The picture came on perfect in every respect except that the horizontal blanking bar appeared in the center of the screen. I can shift the bar slightly with the horizontal control, but after a slight shift the picture breaks up. The horizontal hold and centering controls were replaced without effect.

Picture definition is good and horizontal sync is stable. All component values appear normal. I would greatly appreciate it if you could help me out on this.—H. H., New Berlin, N. Y.

The blanking bar in the center of the screen and the sync stability definitely isolate the trouble in the 6AL5 horizontal a.f.c. circuit. Since this defect followed the replacement of the flyback transformer, the most probable cause of the trouble is a reversed winding on the coil feeding the output signal back to the horizontal a.f.c. circuit.

There is also an excellent chance that the feedback voltage is larger or smaller than normal. Thus, if reversing the polarity of the feedback voltage does not correct the trouble, you will have to experiment with the various resistance and capacitance values in the feedback circuit. The most efficient way to do this is to replace the resistors

with potentiometers. Vary these and use different capacitor values until you find a combination that provides the a.f.c. circuit with a suitable voltage. All this should be done, of course, while watching the screen. When normal horizontal action is obtained, replace the potentiometers with fixed resistors equal to the value then in the circuit.

**Noisy channel switch**

A Motorola chassis in the shop has an extremely noisy channel-selector switch. This set uses the TT-15 tuner with a 6CB6 r.f. amplifier and a 12AT7 converter. Both tubes have been substituted and all connections checked as well as could be done without disturbing the wiring. I am fairly sure the trouble is in the channel switch because the noise occurs on some, but not all, channels. In addition, the slightest movement of the selector shaft produces considerable noise. I applied some carbon tet to the contacts but there was no apparent reduction in the noise.

The picture and synchronization are otherwise perfect. The set is very sensitive and the defect is not at all noticeable unless the selector shaft is rotated or touched. Perhaps you could suggest some better type cleaner.—R. G., Olympia, Wash.

The type of cleaner used for removing dirt from tuner contacts is not nearly as important as the manner in which it is applied. Dirt usually accumulates on the contact rotor plate or the contact friction spring. The first indications are noisy switching. When more dirt gathers, picture quality becomes very poor.

There are many good contact cleaners on the market that will do a better job than carbon tetrachloride. Apply the cleaner liberally to both the rotor plate and the friction spring. Then rotate the channel selector switch

at least twice through its complete range.

As an added precaution tighten the nuts that hold the switch contacts and coils in place. This will give you a good connection between the contact friction spring and the contact rotor plate. Don't use too much muscle on the nuts because the insulating washer under one of them breaks rather easily—tighten carefully.

**Vertical jitter and buzz**

I am working on an Admiral 21B1 receiver that has a continuous audio buzz. The picture jitters most of the time. The sync pulses from the sync circuit appear to be steady and of normal amplitude. I have replaced the vertical integrator network and checked most of the components in the vertical oscillator and amplifier circuits, and have replaced the tubes.

Wiring has been checked and all audio-circuit wiring is carefully dressed away from the vertical and horizontal circuits. When I vary the vertical hold control, the buzz gets higher in pitch. However, I have worked the vertical circuit over with a scope and checked with the service manual and couldn't ask for more perfect results. I would like to hear any further hints you might suggest.—N. F., Green Bay, Wis.

The most interesting part of the information you supplied is that the pitch of the sync buzz changes when you rotate the vertical hold control. This indicates that the interference is being produced in the vertical sweep stages since the change in pitch is the change in vertical oscillator frequency. It further indicates that there is a breakdown or arcing in the vertical output transformer or vertical deflection coils. Judging from the normal ratio of breakdowns it is far more likely that the defect is located in the vertical output transformer. END

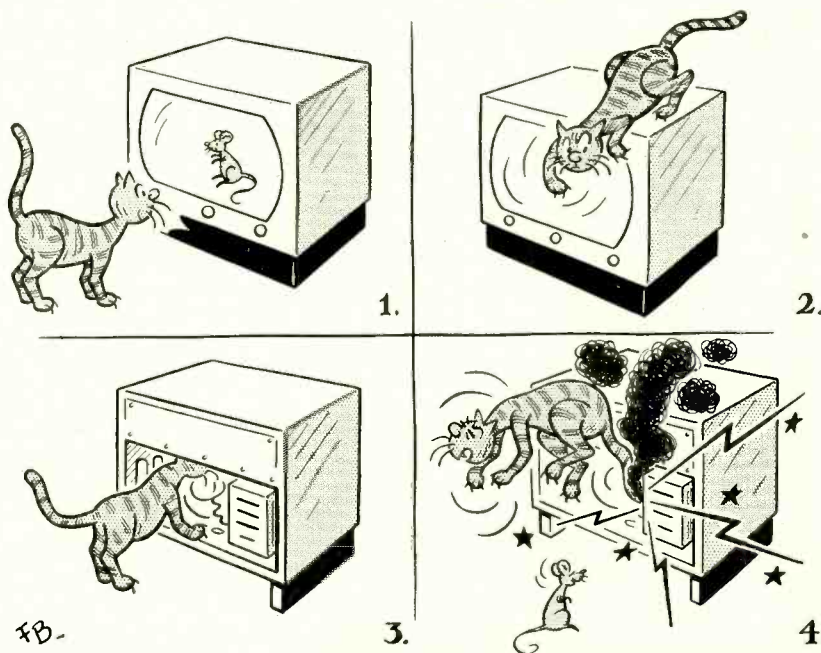

Suggested by Jerry Smith, Bethel, Maine

# World's most adaptable replacement cartridge!

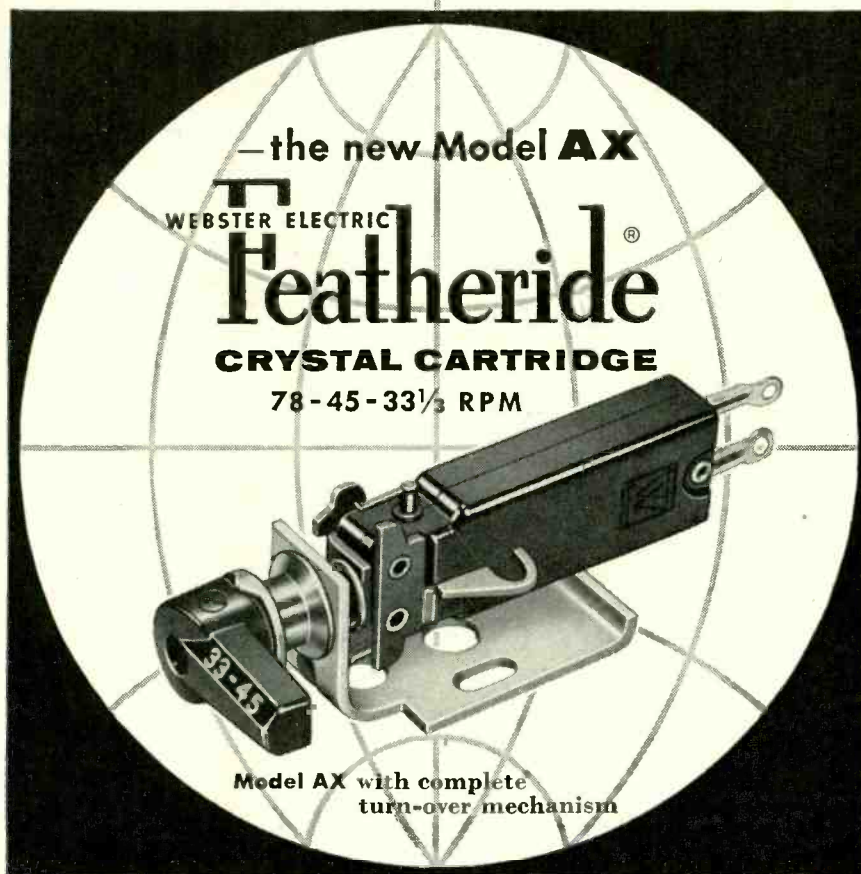

Model AX with complete turn-over mechanism

• The new MODEL AX is a universal turn-over replacement cartridge in the highest sense! Lightweight, compact, beautiful in playing qualities, it can be used to replace all standard automatic changer turn-over cartridges.

Unequaled versatility is only one of the advantages of the MODEL AX. In addition, it has high compliance, excellent tracking, fine response at all speeds—and a wholly new, advanced design. Illustrations show how it can be quickly adapted to virtually any type of turn-over arm.

Model AX with knob and bracket removed, for installation in arms with built-in front mounting bearing

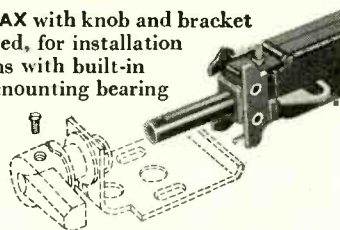

Model AX with scored shaft snapped off, for installation in arms containing complete turn-over mechanism with 1/2" standard mounting

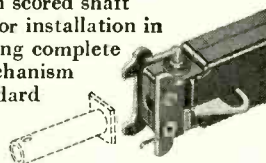

## specifications • data

**Output** • (1000 CPS): 0.7 volt at 33 1/3-45 rpm; 1.5 volts at 78 rpm

**Tracking pressure** • 7 grams

**Cut-off Frequency** • 10,000 cycles

**Mounting** • Standard 1/2", either with or without turn-over mechanism or front mounting as shown above

**Needles** • 3 mil osmium for 78 rpm (WE 52)  
1 mil osmium for 33 1/3-45 rpm (WE 52 LP)

**WEBSTER ELECTRIC**  
RACINE WISCONSIN

## TELEVISION

### V.T.V.M. Orients TV Antenna

YOU can adjust your antenna direction for optimum reception of any v.h.f. or u.h.f. station, using a v.t.v.m. and a simple adapter.

With antennas of the open circuit type, such as V's and conicals, only two small resistors and capacitors are needed (see diagram).

The resistors prevent shorting the signal and yet place the a.g.c. voltage on the transmission line. The blocking capacitors prevent shorting the a.g.c. voltage through the antenna coil of the tuner.

**WARNING:** This method is not recommended for use with sets that are "hot to ground" unless an isolation transformer is used between the set and the a.c. line.

By having the a.g.c. voltage available for measurement directly from the transmission line, it is possible to take your v.t.v.m. on the roof and adjust the direction of the antenna for maximum a.g.c. indication on the meter

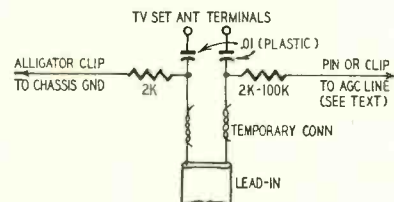

after a station has been selected at the receiver.

Most v.h.f. antennas have several lobes of good u.h.f. response at various directions around the antenna. In my own case one of the v.h.f. lobes gives an excellent signal from local channel 40 when the antenna is pointed in an entirely different direction for best reception of v.h.f. signals from San Francisco, about 90 miles away.

True, you can use a field-strength meter, but more people have a v.t.v.m.; and the TV set is here used as the field-strength meter. Also many receivers (Philco for example) make the a.g.c. voltage available from a test socket on top of the receiver chassis, which is convenient for using this system.

For TV sets in which the a.g.c. bus is difficult to reach, a socket adapter can be used under the detector or a.g.c. tube so that the signal diode (or a.g.c. tube plate) may be reached without removing the set. If this is done, the a.g.c. isolation resistor should be increased to 100,000 ohms.

This method may also be used with antennas of the closed loop type, such as folded dipole, if two more capacitors are temporarily inserted in the transmission line above the point at which the v.t.v.m. is connected.

The ground lead of most v.t.v.m.'s is usually terminated with an alligator clip. It is a good idea to put one on the test prod too before taking it on the roof. This leaves both hands free for turning the antenna. (Turn the mast with a pipe wrench.)—Louis Bourget

# Technicians News



## INDIANAPOLIS UNITY MEET

Delegates from widely separated parts of the country met at Indianapolis on Oct. 9 to discuss and, if possible, implement unification of the nation's various service groups. Joe Barg, attorney and executive director of the Cincinnati Association of Television Service Companies, was elected chairman, and Murray Barlowe of the Radio Television Guild of Long Island, vice chairman.

At the date of writing, reports on the meeting were still somewhat confused and tended to reflect the opinions of the various reporters, but it is clear that early in the meeting the sentiment for one organization rather than a loose union of existing associations and federations prevailed over all other viewpoints.

Forest Baker of the Texas Electronic Association presented a plan based on the Texas organization of a state group made up of local associations and showed with the help of charts how the setup could be expanded to cover the country. The plan would organize 4 groups of 12 states each into a division and the 4 divisions would send representatives to a national meeting.

Murray Barlowe of the Long Island Guild, a member of the New York State federation, a somewhat similar setup to that of Texas, endorsed the proposition, pointing out that such a form of organization gave the best assurance of democracy.

Barlowe then moved that a new association be formed, incorporating all existing local, state and national groups, and that such association be democratically controlled, with direction coming from local organizations rather than from the office of the president. The motion was seconded and presented for discussion by the chairman. Discussion followed but the motion was apparently lost sight of later in the meeting as none of the participants queried remembered either its withdrawal or other disposition.

Frank Moch, National Alliance of Television & Electronic Service Associations (NATESA) president, then took the stand, presenting NATESA as just such an organization as that outlined, and suggested it might be foolish to proceed to build a new national group under the circumstances.

Al Saunders (Boston), spoke in support, stating that he could not persuade

the New England associations to go along with the idea of a new group after having worked to unify them in NATESA. John Graham, veteran member of the Columbus, Ohio, association, said that he believed NATESA had all the elements necessary for a unified national group. Mr. Barg then spoke from the chair, calling special attention to Mr. Moch's devoted work in building NATESA and urging the delegates present "not to change the foundation" even though they might want to change the form of the organization.

Al Bernsohn, managing director of the National Appliance & Radio-TV Dealers Association (NARDA), made an impassioned plea for unity and the need for a professional national group. He stated that NARDA would be willing to turn over all the work done by its service division to a group of this type and to give freely of its time and experience to make such a group successful. John Hemak, of MINTSE (Minnesota Television Service Engineers), spoke of the role of the state organization and discussed the areas in which a state group would be effective. Max Liebowitz of National Electronic Technicians & Service Dealers Associations (NETSDA), outlined the "umbrella" type of organization he had introduced at an earlier Pittsburgh meeting.

Barg again took the lead and examined Mr. Moch on various phases of NATESA's structure and methods. At one point Bert Bregenzler objected to Moch's statement that organizations wishing to affiliate with NATESA would have to be investigated by that body. He stated that the older Eastern organizations would consider such a demand an affront. Al Bernsohn then raised a point of order, stating that Barg was acting improperly in discussing NATESA as if it were already selected as the accepted organization. In this he was supported by Barlowe. After some display of feeling throughout the meeting over being investigated by NATESA, Mr. Barg suggested an emergency meeting between Mr. Moch and state representatives. The meeting agreed that a group consisting of one representative from each state in attendance, with an additional representative from NATESA in those states where there was duplication of associations, should meet to try to work out concessions and bring a resolution in to the main body. After

considerable discussion, said to be chiefly concerned with the question of a suitable name for the new body, the delegates evolved this resolution:

"That we go back to the general meeting and ask our groups to join NATESA and at the next general meeting, no later than April, 1956, make any changes found necessary; and that any qualified association will be immediately accepted without investigation if application is received before Feb. 7, 1956."

The resolution was presented to the main body and accepted by a voice vote. Following adjournment, however, some delegates reported that about all they could do would be to take the resolution back home and present it to their members. Doubt especially, was expressed about the attitude of the older Eastern groups, who were not too well represented. The Pennsylvania federation (FRSAP), oldest and possibly strongest of all state groups in the country, was represented only by Pittsburgh, and ESFETA (Empire State Federation of Electronic Technicians Associations), only by the Long Island Guild and the New York City Association (ARTSNY). There is still a possibility of another meeting after the delegates have obtained the reaction of their local and state associations. This consideration prompted the withdrawal of a motion to disband the Electronic Service Council, and it is upon such a meeting that the possibility of further progress toward unity in the service field rests.

## GUILD WANTS TO BUY!

A novel approach to the retailing distributor problem was made in a recent letter from the Radio and Television Guild of Long Island. Addressed to Mr. Don C. Mitchell, president of Sylvania, the letter said in part:

"The electronic industry is well aware of Sylvania's past record of cooperation with the independent service industry. The Radio Television Guild of Long Island, representing over 300 service dealers and technicians, is confident that your company would not want to be instrumental in putting the independent service dealer in an unfair competitive position. . . .

"These are the facts:

"Long Island is presently without a 'wholesale' Sylvania distributor . . . The franchised dealers appointed by your company to serve the service dealers in this area are in *open competition* with them for the same customer, the retail consumer. The independent service dealer is placed in the unfair position of having to compete with his supplier, without the benefit of the franchise which provides an additional discount.

"Under the provisions of the Robinson-Patman Anti-Discrimination Act it is unlawful for a manufacturer engaged in interstate commerce to discriminate in price between different purchasers of commodities of like grade and quality.

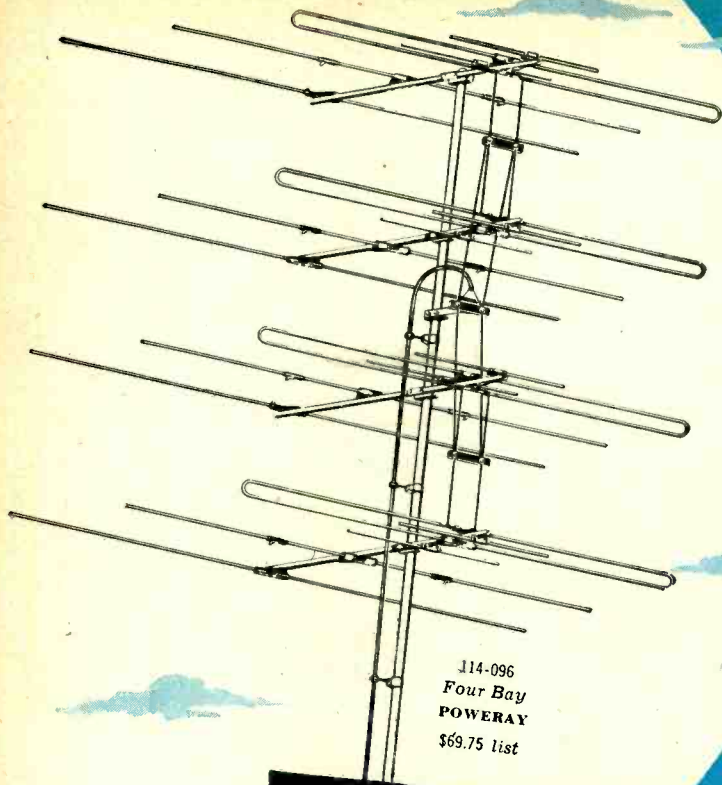

# POWERAY

fringe area antenna

**NEW**

## REVOLUTIONARY Sleeve Dipole Principle...

**POWERAY** is an outstanding new antenna design for fringe and deep-fringe areas. Based on a unique variation of the sleeve dipole principle, **POWERAY** provides better TV pictures miles away from the station. The sleeve dipole principle is based on resonance of the overall length at a low frequency and resonance of a 3-wire transmission line section at a high frequency. Only this new design properly balances *high gain, directivity and exact impedance match* for better fringe area reception.

### PREASSEMBLED

**POWERAY** is preassembled for less installer-time on the job. Easily and quickly put up, **POWERAY** provides superior performance for years.

*For complete customer satisfaction and full profit margins—it's **POWERAY**, AMPHENOL's exceptional fringe area antenna*

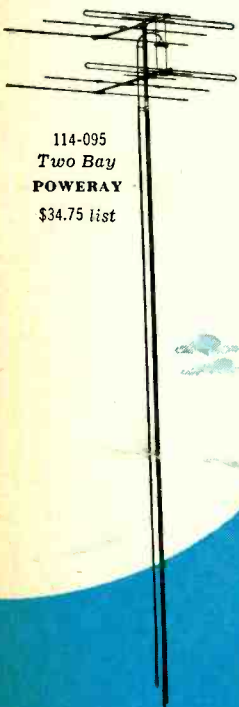

114-095  
Two Bay  
**POWERAY**  
\$34.75 list

AMERICAN PHENOLIC CORPORATION  
chicago 50, illinois  
AMPHENOL CANADA LIMITED  
toronto 9, ontario



### TECHNICIANS NEWS (Continued)

"To correct these unfair conditions as they exist today, we, the members of the Radio Television Guild of Long Island, formally request the opportunity to buy our Sylvania products from you (directly or otherwise) at the same price as do our competitors."

The letter and reply from Sylvania were published in the September issue of the *Guild News*.

### TISA NOW TESA

The Television Installation Service Association (TISA), of Chicago, has voted unanimously to change its corporate title to the Television Electronic Service Association (TESA), thus becoming possibly the first association to put into effect the recommendation of the 1955 NATESA convention. Because TISA has spent thousands of dollars to build up prestige for the name, which it has carried longer than most TV service associations, it is believed that the action will do much to speed up the adoption of the TESA name by other NATESA affiliates.

### TECHS VISIT CHERRY HILL

RCA Service Co. recently conducted a two-day seminar to discuss black-and-white and color TV and other matters affecting the electronics service industry. Prominent members of service organizations were guests of RCA Service Co.

The service technicians were conducted on an inspection tour of RCA's new service facilities at Cherry Hill (Camden, N. J.) and on the second day made a tour of the David Sarnoff Research Center at Princeton, N. J. They were also introduced, by discussion and demonstration, to the experimental electronic refrigerator, music synthesizer, light amplifier and other electronic equipment of the future.

### CHICAGO PROGRAM

The Associated Radio and Television Servicemen of Chicago have released a lecture program for the fall and winter. The series includes such subjects as financing and credit as well as technical information. Current lectures are: Nov. 29, Richard Harasek of Motorola, on printed circuits; Dec. 14, Eugene Reichstetter, Dun & Bradstreet, Chicago, on credit and credit ratings; Jan. 17, 1956, L. J. Couch of Sylvania, on transistors. A second part of the series is being projected and will cover business topics of interest to the small shop owner. It is expected that advertising, income tax and public relations will be the main subjects.

### PR SMA HAS DE LUXE HALL

The Philadelphia Radio Service Men's Association has arranged with the Franklin Institute to use their lecture hall on the first Tuesday of each month.

The hall, according to PR SMA president Dick Devaney, seats 350 people, has provision for moving pictures or slides and is air-conditioned. END

**MISCELLANY**



**THE FUND REACHES  
\$11,816.73**

**HELP -  
FREDDIE-WALK  
FUND**

WE are constantly surprised and gratified by the continued response to our appeal to "Help Freddie Walk" and are certain our readers will be as happy as we are to note that the Fund has reached almost \$12,000. This will go a long way toward helping little Freddie Thomason, armless and legless son of Herschel Thomason, radio technician of Magnolia, Ark., grow into a healthy, productive adult.

As we go to press, the school term has started and Freddie, like every other 7-year old, is probably deep in the mysteries of reading, 'riting and 'rithmetic . . . and very likely dreaming about *next* summer.

Born without arms and legs, Freddie is otherwise exactly like every other child, looking to the future and planning in his own way to when he will be "grown up." Freddie has already been fitted with legs and has learned to use them admirably. Soon he will be fitted with mechanical—we hope electronic—mechanical—arms and hands to help him explore his world further.

But as he grows, these appliances must grow with him. It is an expensive proposition, one that the Thomasons cannot hope to handle alone.

Won't you do your bit to help? No contribution is too small to receive our sincere thanks and acknowledgment, and you will know that every penny of your donation is put to good use in a worthy cause. *Make out all checks, money orders, etc., to Herschel Thomason.* Send all contributions to

Help-Freddie-Walk Fund  
c/o RADIO-ELECTRONICS Magazine  
25 West Broadway  
New York 7, N. Y.

RADIO-ELECTRONICS Contributions as of July 5, 1955.....	\$11,078.86
FAMILY CIRCLE Contributions.....	602.50
Anonymous, San Francisco, Calif.....	50.00
Anonymous, Hartford, Conn.....	1.00
Anonymous, Amherst, Mass.....	1.00
Anonymous, Brooklyn, N. Y.....	25.00
Anonymous, Philadelphia, Pa.....	1.00
Columbia Broadcasting System, Inc., for account Jose Manuel Flores	7.37
A. H. Danter, St. Louis, Mo.....	5.00
Philip R. Dodge, Pittsburgh, Pa.....	2.00
Van H. Ferguson, Tallahassee, Fla.....	5.00
H. Goldstein, White Plains, N. Y.....	15.00
G. T. Harris, Richmond, Va.....	5.00
Lizzie K., Dayton, Ohio.....	3.00
Karl W. Koenig, New York, N. Y.....	2.00
Margaret Morrissey, Worcester, Mass.....	1.00
J. R. Simpson, Rockville, Md.....	2.00
Steven Warhol, Saint Paul, Minn.....	5.00
Anthony J. Zugel, Washington, D. C.....	5.00
TOTAL CONTRIBUTIONS as of Oct. 10, 1955.....	\$11,816.73

# Half the fun is building it... with a **TECH-MASTER** Kit!



Yes, you'll enjoy building a Tech-Master Kit almost as much as you'll enjoy using the finished product. Simple, step-by-step pictorial diagrams guide your every move right down to the last detail. Your feeling of pride and accomplishment will be well justified when you plug in the last tube and put your unit to its initial test. Then you will definitely agree, as do thousands of others, that when you build with Tech-Master, you build the best.

*New*

**HI-FI  
FM TUNER**

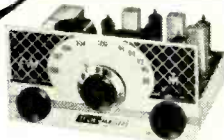

Self-contained power supply • Tuning range 87-109 Mc • 200Kc IF bandwidth • Grounded-grid RF stage • AFC with front-control cutoff • Microvernier tuning • No-drift ratio detector • 4 uv sensitivity for 20 db quieting • Standard de-emphasis network • .8 volt RMS cathode-follower output • 3.2 volt RMS high-impedance output • 300 ohm input impedance • Switch-controlled AC receptacle for auxiliary equipment.  
**Model FM-18**, complete with punched chassis, tubes, and hardware (less wire and solder).....**\$29.50**

*New*

**WILLIAMSON  
TYPE  
20-WATT  
AMPLIFIER**

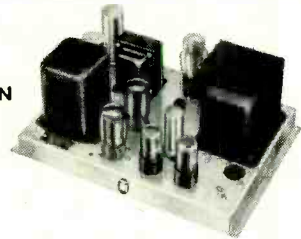

Frequency response flat and smooth thru entire audible range • Less than .0025 distortion at normal listening levels • Excellent transient characteristics.  
**Model TM-15A**, complete with tubes — sockets, terminal strips, and connectors mounted.....**\$49.95**

*Deluxe*

**Self-Powered  
PREAMPLIFIER  
EQUALIZER**



Cathode-follower output • Loudness-compensating control • Input selector • 4 input channels • Independent bass and treble boost and attenuation • 5-position equalization control • AC receptacle for auxiliary equipment • Self-contained power supply.  
**Model TM-16SP**, complete with matching gold escutcheon.....**\$24.50**

*Economy*

**PREAMPLIFIER  
with Cathode  
Follower Output**



4 input channels • Separate bass and treble controls • 3-position equalizer • AC outlet for auxiliary equipment • Powered by main amplifier.  
**Model TM-17P**, complete.....**\$19.95**

*America's  
Finest*

**630-TYPE  
TV KIT**

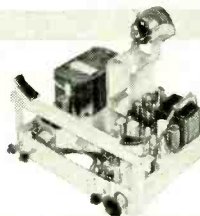

Advanced Cascode turret • AFC horizontal sync. • 3-stage sync. amplifier, clipper and separator • 4-stage stagger-tuned video IF • Adjacent-channel trap • 2-stage video amplifier • Direct-coupled keyed AGC circuit • 5 microvolt sensitivity • For 21" to 27" (90°) picture tube.  
**Model 630-9**, complete with all components, brackets, speaker, and tubes (less kine, wire and solder).....**\$159.50**

*New T-V  
CRAFT KIT*

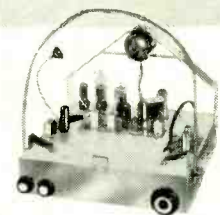

Super-selective 12-channel turret tuner • IF section completely wired and aligned • 9 microvolt sensitivity • 3-stage stagger-tuned IF • AGC • Syncro-guide AFC with horizontal hold • Ceramic core horizontal output xmfr with beam power amplifier. For L.V. electrostatic kines 17"—21".  
**Model 5516W**, complete with tubes, hardware, and brackets (less kine, wire, and solder).....**\$94.50**

*Note:* The quality and performance of Tech-Master kits reflect the combination of long experience, skilled engineering, and painstaking craftsmanship, which has made Tech-Master the foremost name in Custom Television. This is your assurance of the uniform excellence of every Tech-Master product.



*Deluxe*  
**SUPERHET  
AC-DC RADIO**

Broadcast Band — 550-1720 KC • Super-sensitive circuit with built-in loop antenna • AVC • 5 tubes.  
**Model 3B5K**, complete with tubes and handsome bakelite cabinet (less wire and solder).....**\$19.95**

Television • Radio • Audio  Write for latest catalog of complete Tech-Master line  
**TECH-MASTER CORPORATION**  
75 Front Street, Brooklyn 1, N. Y.

# BUILD 16 PRINTED CIRCUIT AND METAL CHASSIS RADIO CIRCUITS

With the New Deluxe 1956  
PROGRESSIVE RADIO  
"EDU-KIT"

ONLY \$19.95 Complete

Build 16 Receiver, Transmitter,  
Code Oscillator, Signal Tracer,  
Signal Injector Circuits

- Learn Practical Radio Theory and Construction
- Free Soldering Iron, Tester & Other Extras
- 30 Day Money-Back Guarantee
- No Knowledge of Radio Necessary
- No Additional Parts Needed
- Excellent Background for TV
- Learn High Fidelity
- Used in 79 Countries
- School Inquiries Invited



**FREE**

Radio and Television  
Servicing Literature  
on Request.  
(See Coupon Below.)

Reg. U.S. Patent Office Pending

## WHAT THE "EDU-KIT" OFFERS YOU

Our Kit is designed to provide a fundamental background in radio, with the basic facts of Radio Theory and Construction Practice expressed simply and clearly. You will gain a knowledge of basic Radio Principles involved in Radio Reception, Radio Transmission and Audio Amplification. You will learn how to identify Radio Symbols and Diagrams; how to build radios, using regular radio circuit schematics; how to mount various radio parts; how to wire and solder in a professional manner. You will learn proper chassis layout, you will learn how to troubleshoot circuits. You will learn how to troubleshoot radios. You will learn code. You will receive training for F.C.C. Novice License. You will learn High Fidelity. In brief, you will receive a practical basic education in Radio, worth many times the small price you pay.

## THE KIT FOR EVERYONE

The Progressive Radio "Edu-Kit" was specifically prepared for any person who has a desire to learn Radio. The Kit has been used successfully by young and old in all parts of the world. It is not necessary that you have even the slightest background in science or radio.

The Progressive Radio "Edu-Kit" is used by many Radio Schools and Clubs in this country and abroad. It is used by Armed Forces Personnel and Veterans throughout the world.

The Progressive Radio "Edu-Kit" requires no instructor. All instructions are included. All parts are individually boxed, and identified by name, illustration and diagram. Every step involved in building these sets is carefully explained.

## "LEARN BY DOING"—PROGRESSIVE TEACHING METHOD

The Progressive Radio "Edu-Kit" comes complete with instructions. These instructions are arranged in a clear, simple and progressive manner. The theory of Radio Theory, Radio Reception, Audio Amplification and servicing by Signal Tracing is clearly explained. Every part is identified by illustration and diagram. You will learn the function and theory of every part used.

The Progressive Radio "Edu-Kit" uses the principle of "Learn by Doing." Therefore you will build radio circuits, perform jobs, and conduct experiments to illustrate the principles which you learn. These circuits are designed in a modern manner, according to the best principles of present-day educational practice. You begin by building a simple radio. The next set that you build is slightly more advanced. Gradually, in a progressive manner, you will find yourself constructing still more advanced multi-tube radio sets and doing work like a professional Radio Technician. Altogether you will build Receiver, Transmitter, Code Oscillator, Signal Tracer, Signal Injector Circuits—16 in all. These sets operate on 105-125 V. AC-DC. For use in Foreign Countries having 210-250 Volt Source, an Adaptor for 210-250 V. AC-DC operation is available.

## THE PROGRESSIVE RADIO "EDU-KIT" IS COMPLETE

You will receive every part necessary to build 16 different radio circuits. Our "Edu-Kit" contains all tubes, tube sockets, variable, electrolytic, and paper condensers, resistors, tie strips, coils, hardware, tubing, Instruction Manuals, Printed Circuit Materials, etc. No solder or wire included.

Every part that you need is included. These parts are individually packaged, so that you can easily identify every item. A soldering iron is included, as well as an Electrical and Radio Tester. Complete, easy-to-follow instructions are provided. All parts are guaranteed, brand new, carefully selected and matched.

In addition, the "Edu-Kit" now contains lessons for servicing with the Progressive Signal Tracer and Signal Injector, F.C.C. Instructions, quizzes, High Fidelity Instructions.

## TROUBLE-SHOOTING LESSONS

Trouble-shooting and servicing are included. You will be taught to recognize and repair troubles. You will build and learn to operate a professional Signal Tracer and Signal Injector. You will receive an Electrical and Radio Tester, and learn to use it for radio repairs. While you are learning in this practical way, you will be able to do many a repair job for your neighbors and friends, and charge fees which will far exceed the cost of the "Edu-Kit." Here is your opportunity to learn radio quickly and easily and have others pay for it.

## "EDU-KIT" Now Includes PRINTED CIRCUITRY

You build a Printed Circuit Signal Injector, a servicing instrument that can detect many Radio and TV troubles. A Printed Circuit is a sheet of insulating material on which has been deposited a conducting material which takes the place of wiring. Various parts are plugged in and soldered to terminals. This new process is now popular in commercial radios, TV, hearing aids, etc.

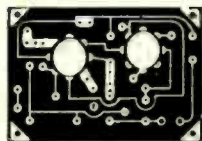

## FREE EXTRAS

- RADIO & ELECTRICAL TESTER
- TESTER INSTRUCTION MANUAL
- FIDELITY GUIDE
- 30-DAY UNCONDITIONAL MONEY-BACK GUARANTEE
- ELECTRIC SOLDERING IRON
- TELEVISION BOOK
- HIGH FIDELITY SERVICE
- QUIZZES
- CONSULTATION SERVICE

## "MAIL TODAY—ORDER SHIPPED SAME DAY RECEIVED"

- Send "Edu-Kit" Postpaid. I enclose full payment of \$19.95.
- Send "Edu-Kit" C.O.D. I will pay \$19.95 plus postage.
- Send me FREE additional information describing "Edu-Kit." Include FREE valuable Radio and TV Servicing Literature. No obligation. (Outside U.S.A.—No C.O.D.'s. Send check on U.S. bank or Intern'l M.O. "Edu-Kit" for 105-125 V. AC/DC \$20.95; for 210-250 V. AC/DC \$23.45)

Name \_\_\_\_\_  
Address \_\_\_\_\_

PROGRESSIVE "EDU-KITS" INC.

497 Union Ave., Room 111G, Progressive Bldg., Brooklyn 11, N.Y.



**FRINGE-AREA ANTENNA**, Poweray, utilizes short antenna elements in series with a section of simulated 3-wire transmission line and unique reflector system. Sleeve dipole for

increases mechanical and electrical efficiency, cuts down installation time. Extra dipoles, harnesses, phasing stubs completely eliminated.—Walco Electronics Corp., 3602 Crenshaw Blvd., Los Angeles 16, Calif.

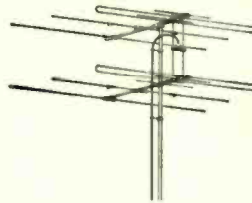

**ANTENNA**, Wayco Master, uniform high gain on channels 2-13. Functions as phased collinear array on channels 7-13 and as end-loaded broad-band

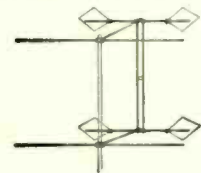

close centering of impedance characteristic for optimum performance and match between antenna, lead-in and TV set. 2- and 4-bay models for fringe and deep-fringe areas.—American Phenolic Corp., Chicago 50, Ill.

**MULTISET TV COUPLER**, Taco model 825, available as 2- and 3-way splitting devices. Weatherproof cases; designed for exterior installation, reducing long indoor runs of transmission line. Voltage-splitting type not requiring power line connections. In high signal-strength areas used in tandem. Adapted for use with broad-band, high-gain Taco Su-

dipole with reflector for low-band operation. Standard and deluxe models; deluxe carries full 5-year guarantee.—Wayco Inc., Waynesboro, Tenn.

**MAGNETIC TAPE RECORDER**, model 360 Crestwood Concerto, table unit with accessory legs which screw into base for conversion to armchair-height console. Woofer and tweeter speaker system baffled to reproduce full music range. Push-button control, printed circuit preamplifier, 10-watt power amplifier. Ample space for storage of microphones,

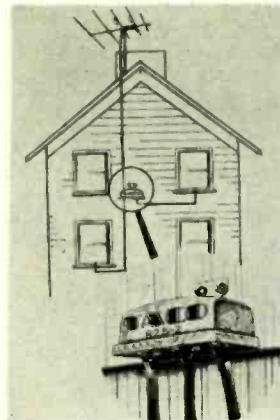

per Trapper model 1890 antenna.—Technical Appliance Co., Sherburne, N. Y.

**SUPER-FRINGE TV ANTENNA**, Wizard, gives high gain, sharp directivity on all v.h.f. channels. Parasitic phase reverser (metal shield mounted in front of receiving element)



ords and 4 7-inch reels of magnetic tape. Mahogany or blondwood.—Daystrom Electric Corp., 753 Main St., Poughkeepsie, N. Y.

**30-WATT AMPLIFIER**, model 80-AZ, features Fisher Z-Matic circuitry, PowerScope—peak-power indicator calibrated in



NEW!

NOISELESS!

ELECTRONIC!

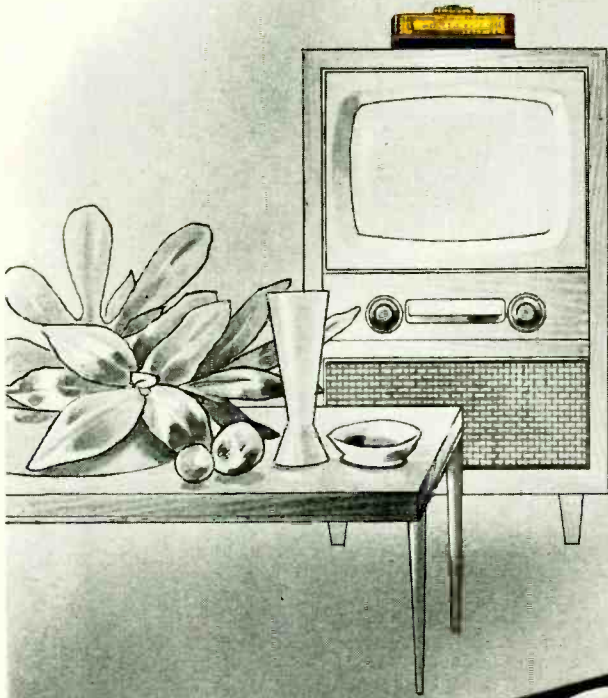

**Thompson Products**

*Automatic*

**Superotor®**



**INTERCHANGEABLE ROTORS** . . . . .

Famous time-proved Superotor models "100" and "500" have both been adapted for automatic operation!

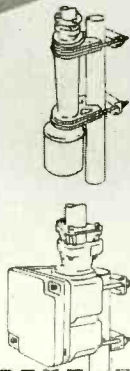

World's only *silent* automatic antenna rotor! No gears, no click, no clatter. Electronic fingertip VP\* tuning. Antenna rotation and control is smooth, not in "steps" like ordinary automatics — provides a new standard of tuning accuracy for Fringe, UHF and Color reception. Write today for specifications.

\*VP (Vernier Precision)

**OTHER THOMPSON PRODUCTS  
ELECTRONIC AFFILIATES**

- Bell Sound Systems • Dage Television
- Ramo-Wooldridge Corp. • Pacific Semi-Conductors, Inc.

**ELECTRONICS DIVISION**

**Thompson Products, Inc.**



2196 CLARKWOOD ROAD • CLEVELAND 3, OHIO

Available in Canada thru Atlas Radio Corp., Ltd., 50 Wingold Ave., Toronto

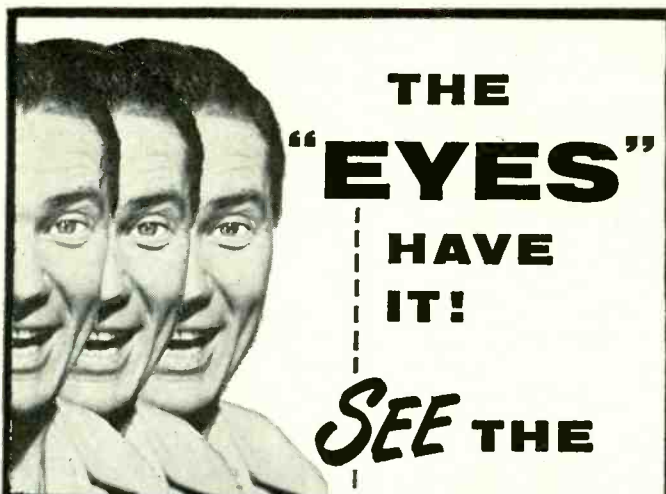

THE "EYES" HAVE IT! SEE THE

FEATURE-BY-FEATURE SUPERIORITY OF EMC TEST EQUIPMENT

NEW RF SIGNAL GENERATOR EMC Model 501

With leads— \$37.90 (Wired & Tested) \$24.90 (Kit Form)



A professional, 6-band (115 KC to 220 MC) generator • produces dependable signals for precision alignment, tuning and adjustment of all types of circuits including COLOR TV.

NEW COMBINATION RESISTANCE-CAPACITY SUBSTITUTION BOX EMC Model 900

\$17.90 (Wired & Tested) \$10.25 (Kit Form)

World's first combination substitution box • quickly determines exact values • provides 18 RETMA Capacity Values and 36 RETMA Resistance Values.



NEW WHITE DOT-CROSS HATCH BAR GENERATOR EMC Model 800

With leads— \$39.90 (Wired & Tested)

Lowest priced, quality color and monochrome generator available • easily adjusts color convergence, width, linearity, ion trap and yoke, etc.



FREE!

Yes, I want to see for myself, send me—FREE—a detailed catalog of the complete EMC line of precision test equipment.

NAME \_\_\_\_\_ RE-12 STREET \_\_\_\_\_ CITY \_\_\_\_\_ STATE \_\_\_\_\_



ELECTRONIC MEASUREMENTS CORPORATION 280 LAFAYETTE STREET, NEW YORK 12, N. Y. EXPORT DEPT. - 370 BROADWAY, N. Y. 13, N. Y.

NEW DEVICES

watts to show peak load on speaker system—and positive indicator to help prevent voice coil damage.—Fisher Radio Corp., 2121 44th Drive, Long Island City 1, N. Y.

WIDE-RANGE MAGNETIC PICKUP, Fluxvalve, turnover type cartridge. Replaceable styli has high compliance for low tracking force (2-5 grams). Frequency response absolutely flat well beyond 20 kc; negligible IM distortion; output of 25 mv at normal recording level. Entire magnetic circuit,

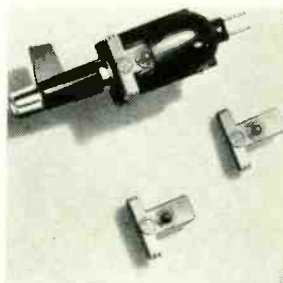

encapsulated in tough plastic. Mounting clip for use with all standard arms acts as bearing for turnover action.—Pickering & Co., Inc., Oceanside, N. Y.

2-SPEED HI-FI TAPE RECORDER, type SR-27, tape transport mechanism and 10-watt amplifier in separate carrying cases. R-27 transport mechanism has 3 magnetic heads to record, erase, play back tape on standard 7-inch reels at 7 1/2 or 15 i.p.s. Single control lever for record, play-

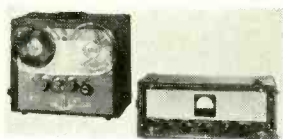

back or fast-speed operation. Amplifier contains microphone, playback preamplifiers, 2 small speakers for low-level monitoring. Microphone inputs of 50 or 250 ohms. Maximum output power 10 watts. At 15 i.p.s., frequency response up to 15,000 cycles, signal-to-noise ratio 50 db, flutter 0.15% r.m.s.—Presto Recording Corp., P. O. Box 500, Paramus, N. J.

PRECISION MAGNETIC RECORDING HEAD, Micro-Gap, designed for specialized indus-



trial applications and professional-quality tape recorders.—Shure Bros., 225 W. Huron St., Chicago 10, Ill.

HI-FI LOUDSPEAKER ENCLOSURE, Karlson 8, for use with 8-inch speakers. 5 models: easy-to-assemble kit, factory-assembled kit; 3-color painted unit; 2 deluxe models finished in blond or mahogany plastic. Karlson 8 kit parts precut, step-by-step account of assembly. Only hammer and glue neces-

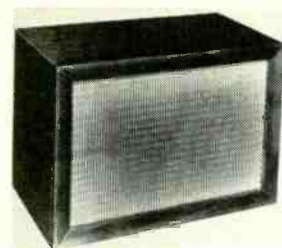

sary. 15 pounds; 17 1/4 x 11 1/4 x 10 inches.—Karlson Associates, Inc., 1610 Neck Rd., Brooklyn 29, N. Y.

NONRESONANT ENCLOSURE, Hartley, 7-section, 2-stage acoustic filter for one or two Hartley 215 nonresonant speak-



ers. 30 x 18 x 16 inches, in blond or mahogany.—Hartley Products Co., 521 E. 162 St., New York 51, N. Y.

LOUDSPEAKER SYSTEM, Shorthorn, now available assembled and finished. Dark mahogany or light primavera wood. May be purchased with Klipsch



Ortho-15 3-way system with 15-inch bass driver, Klipsch Ortho-12 3-way system with 12-inch bass driver, or without drive system. Unfinished utility model available with same choice of drive systems. Corner-horn back loading. Coordinated acoustic elements, including filters.—Klipsch & Associates, Hope, Ark.

POCKET-SIZED KITS hold small replacement parts, particularly Delco auto radio replacement hardware. 4 clear plastic kits are divided into 8 compartments. Chart on cover names part and part number for ordering compartment refills supplied in small plastic



# TOP performance for TV anywhere!

## Federal's "ALL-STAR" LEAD-IN TEAM

*Urban, fringe or distribution system...  
heat, rain, dust, snow, ice, salt spray,  
polluted air... whatever the conditions  
you'll find a winner in these dependable  
Quality-Controlled Cables by "FTR"*

North, East, South, West... wherever there are TV customers... Federal's "All-Star" Lead-in Team can be depended upon to deliver *championship performance*...!

These six popular types are outstanding examples of the quality, ruggedness, efficiency and long life built into every foot of Federal Cable. Whatever the run requirements or local weather conditions the Federal "All-Stars" will score high in satisfaction... with you and your TV customers.

Federal lead-ins can be installed with utmost confidence, because they are engineered and manufactured by a *pioneer* cable maker... and "Certified by a World of Research"... through the International Telephone and Telegraph Corporation.

Check the high points of Federal's "All-Star" Lead-in Team... then get in touch with your Federal Distributor. Always specify "Federal"... *keep* those TV installation profits instead of *paying them back in call-backs!*

*"America's leading producer of  
solid dielectric cables"*

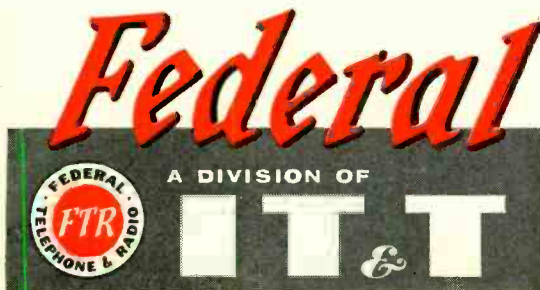

### Economical and Efficient

TV-1190—300-ohm heavy-duty lead-in with 90 mil. web. Has 7/#28 copper strands. Economical and highly efficient. Insulated with Federal-developed "silver" polyethylene for rugged service and long life.



### Another Low-cost Leader

TV-2000—300-ohm dumbbell-shaped lead-in with 55 mil. web. Has 7/#30 copper strands. A high-value, low-cost type for the average installation. Cinnamon-brown color is protection against ultra-violet.



### Heavy-duty Type

TV-1182—300-ohm deluxe type heavy-duty lead-in with 90 mil. web, insulated with Federal's "silver" polyethylene. Resists weather, heat and sun. Very low line loss in fringe areas. Outstanding for long life.



### Quality plus Economy

TV-1184—300-ohm dumbbell-shaped, standard, economy type lead-in for installations in urban areas where there are no unusual conditions. Cinnamon-brown color is highly effective in resisting ultra-violet.



### C-TV Primary Lead-in

RG-11/U—75-ohm shielded low-loss coaxial. One of the best small-diameter cables. Tops as a Community TV primary lead-in. Also can be used with unbalanced input TV receivers in low signal strength areas.



### C-TV Secondary Lead-in

59/U Type—73-ohm coaxial lead-in. Highly efficient as a Community TV pole-to-house tap-off. Meets all needs wherever a high-grade installation is a must. Ideal for use with unbalanced input TV receivers.

For data on other types, write Dept. D-463

### Federal Telephone and Radio Company

A Division of INTERNATIONAL TELEPHONE AND TELEGRAPH CORPORATION  
COMPONENTS DIVISION • 100 KINGSLAND ROAD • CLIFTON, N. J.

In Canada: Standard Telephones and Cables Mfg. Co. (Canada) Ltd., Montreal, P. Q.  
Export Distributors: International Standard Electric Corp., 67 Broad St., New York

NEW DEVICES



bags.—United Motors Service, Div. of General Motors Corp., General Motors Bldg., Detroit 2, Mich.

**AUDIO GENERATOR KIT, model AG-9,** features step-tuning from 10 cycles to 100 kc with 3 rotary switches that provide 2 significant figures and multiplier. Less than 1% distortion. Frequency accurate to within  $\pm 5\%$ . Output monitored on a large  $4\frac{1}{2}$ -inch meter that reads voltage or db. Variable



and step type attenuation provided. Zero-to-maximum reading at each attenuator position.

Output (and meter) ranges: 0-.003, .01, .03, 0.1, 0.3, 1, 3, 10 volts. Rapid selection of desired frequency; accurate return to any frequency.—Heath Co., Benton Harbor, Mich.

**LABORATORY TYPE OSCILLATOR, type 347,** covers 18 cycles to 1.1 mc. Total harmonic distortion of output waveform less than 0.2% over most of useful range. Output voltage constant within  $\pm \frac{1}{2}$  db 18 cycles to 200 kc for any output above 0.1 volt. Output level 10 volts open-circuit; hum and noise level 3 mv or 60 db below signal; power supply 117 volts, 50 to 400 cycles.—



Technical Products Div., Allen B. Du Mont Labs., Inc., 760 Bloomfield Ave., Clifton, N. J.

**5-INCH OSCILLOSCOPE, EICO 460,** kit or wired with step-by-step instructions for assembly and operation. For laboratory, production line and monochrome and color TV servicing. Flat from d.c. to 4.5 mc, usable to above 5 mc; built-in voltage calibrator; 25-mv-per-inch ver-

tical sensitivity; sweep frequencies 10 cycles to 100 kc, plus lower sweep frequencies with external capacitor; re-



trace blanking.—Electronic Instrument Co., Inc., 84 Withers St., Brooklyn 11, N. Y.

**FILAMENT CHECKER, Senco model FC 4,** for finding open filament in series-string TV sets. Checks all octals, loctals,



(Continued)  
7- and 9-pin miniature tubes, picture tubes. To use as continuity checker and neon voltage indicator insert standard test leads in pins 1 and 12 of picture-tube socket. Pocket-sized.—Service Instruments Co., 171 Official Rd., Addison, Ill.

**PRECISION TUBE TESTER AND REJUVENATOR, EMC model 209,** checks all types of vacuum tubes by emission.



Wired and tested in hammer-tone case, in oak carrying case or in easy-to-assemble kit form.  $3\frac{1}{2}$ -inch meter with 3-color good-bad scale. Rejuvenates and repairs all monochrome picture-tube types by using EMC model CRA picture-tube adapter.—Electronic Measurements Corp., 280 Lafayette St., New York 12, N. Y.

**FM WAVE TRAP, MWT-1,** precision tunable, eliminates FM interference in master TV systems and individual TV sets. Mounted on antenna mast, at

Watch for . . .  
**SPECIAL TV ISSUE**  
**JANUARY RADIO-ELECTRONICS**

**opportunities**  
AT  
**BELL TELEPHONE LABORATORIES**

A career for you with one of the nation's leaders in research and development in communications and military electronics.

**ELECTRONIC TECHNICIANS      DRAFTSMEN**  
**ELECTROMECHANICAL TECHNICIANS**

Openings require previous training at high school, armed service school, or technical institute level and in general 2 or more years of applicable industrial or military experience.

Send your name and address for application, telephone collect within 100 miles for information, or visit us Monday through Friday. Evening interviews arranged.

**BELL TELEPHONE LABORATORIES**

WHIPPANY, N. J. (Near Morristown)  
WHIPPANY 8-1000      EXTS. 2786, 300  
MURRAY HILL, N. J. (Near Summit)  
CRESTVIEW 3-6000      EXTS. 3078, 3204  
463 WEST STREET, NEW YORK CITY  
CHELSEA 3-1000      EXTS. 2871, 2873

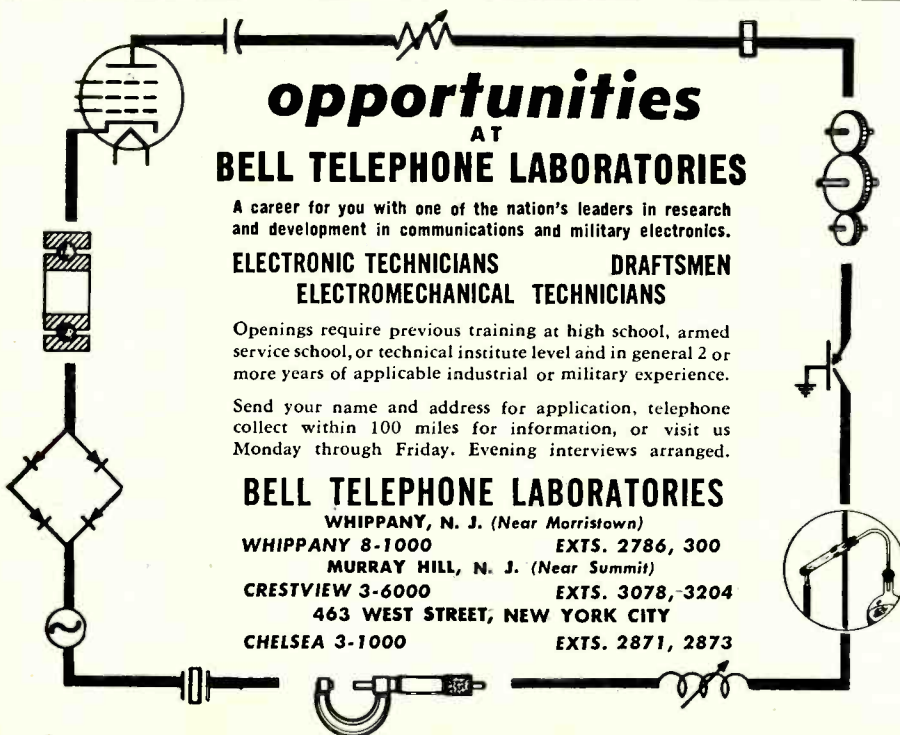

STATEMENT OF THE OWNERSHIP, MANAGEMENT, AND CIRCULATION REQUIRED BY THE ACT OF CONGRESS OF AUGUST 24, 1912, AS AMENDED BY THE ACTS OF MARCH 3, 1933, AND JULY 2, 1946 (Title 39, United States Code, Section 233) of RADIO-ELECTRONICS published monthly at Mt. Morris, Illinois, for October 1, 1955.

1. The names and addresses of the publisher, editor, managing editor, and business managers are: Publisher, Gernsback Publications, Inc., 25 West Broadway, New York 7, N. Y.; Editor, Hugo Gernsback, 25 West Broadway, New York 7, N. Y.; Managing Editor, Fred Shunaman, 25 West Broadway, New York 7, N. Y. Business Manager, none.

2. The owner is: Gernsback Publications, Inc., 25 West Broadway, New York 7, N. Y.; H. Gernsback, 25 West Broadway, New York 7, N. Y.; M. Harvey Gernsback, 25 West Broadway, New York 7, N. Y.

3. The known bondholders, mortgagees, and other security holders owning or holding 1 percent or more of total amount of bonds, mortgages, or other securities are: None.

4. Paragraphs 2 and 3 include, in cases where the stockholder or security holder appears upon the books of the company as trustee or in any other fiduciary relation, the name of the person or corporation for whom such trustee is acting; the affiant's full knowledge and belief as to the circumstances and conditions under which stockholders and security holders who do not appear upon the books of the company as trustees, hold stock and securities in a capacity other than that of a bona fide owner.

H. GERNSBACK, Publisher  
Sworn to and subscribed before me this 16th day of September, 1955.

[Seal]      Irving Abramson,  
Notary Public  
(My commission expires March 30, 1956)

Speed-Up Your Work with the *All-New*  
**RCA SENIOR VOLT OHMYST®**

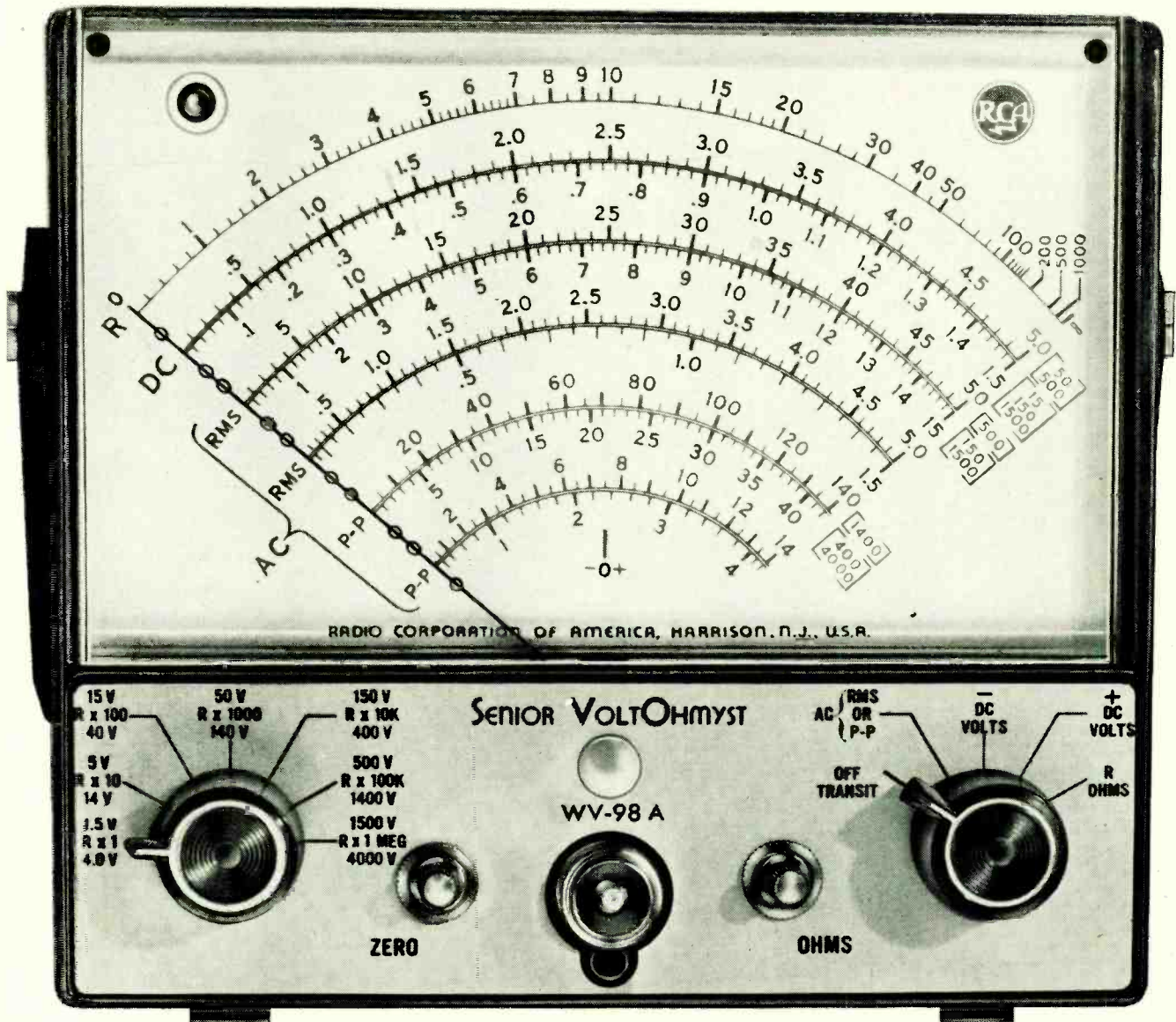

Senior VoltOhmyst, RCA WV-98A, only \$75.00 User Price\* including probe and cable, instruction booklet, complete and ready-to-use... Shown slightly smaller than actual size.

\*Optional

*new!*

You can work faster, more accurately — when you own and use the new RCA WV-98A SENIOR VOLT OHMYST with the extra-large full-vision meter-face. "Speed-up" in your service work — without the slightest sacrifice in quality — means a "build-up" in your profits. Look at the easy-to-read expanded scales. Then look at some of the other advanced features you also get.

- Large, easy-to-read, wide-vision meter (6½" w).
- Expanded meter scales... separate peak-to-peak voltage scales.
- Accuracy of 3% full-scale on BOTH ac and dc voltage measurements.
- Sturdy, single-unit streamlined probe with built-in ac-ohms/dc switch.
- Rugged die-cast aluminum case.
- Compact design: 7" wide, 3¼" deep, 6½" high, 6 lbs.

The all-new WV-98A has all the important, time-proved performance features of earlier VoltOhmysts including direct reading of peak-to-peak voltages of complex waveforms. See this highly accurate, versatile, service instrument at your RCA Distributor! Order now.

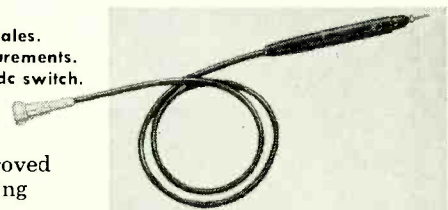

NEW! WG-299A slim, single unit DC/AC-Ohms Probe and Shielded cable is provided with the RCA WV-98A. Probe has handy built-in switch permitting instant selection of dc or ac/ohm operation.



**RADIO CORPORATION of AMERICA**  
 TEST EQUIPMENT HARRISON, N. J.

® Trade Mark "VoltOhmyst" Reg. U.S. Pat. Off.

# Quality Kits . . . Backed By 23 Years of Electronic Manufacturing Experience by G. E. E. Co.

## Super Sensitive GEIGER COUNTER KIT AEK100

Features found only in much higher priced kits. Batteries incl. (not sold less batt.)

Geiger tube 900 volt halogen quenching type, protects against burnouts. 100 counts per min. Detects minimum radiation harmful to health; detects presence of uranium or other radio-active ores. Simple operation, rugged construction. Low cost battery replacement. High gain power amplifier, ultra sensitive geiger tube for phenomenal high sensitivity. Radio-active sample & headphone incl. Has shoulder carrying strap, long battery life, unlimited life geiger 900 volt tube, halogen quenched, unaffected by light or temperature (-50° to 125°), finely finished all steel case.

AEK100 Geiger Counter Kit complete as above with batteries, tubes wiring & assembly & operating instructions..... 19.65  
AE100—complete factory built, ready to operate..... 32.95



## Wide Band 5 In. Oscilloscope Kit Model 555K

Compare outstanding performance with higher priced kits. For color TV & black & white. Ideal for general lab & service application. Push pull 3 stage vertical amplifier with cathode plate follower circuit • Multivibrator type sweep generator 15 to 150,000 CPS • Compensated step type attenuator • Z axis modulation available • Anastigmatism control built in (spot size) • Retrace blanking • 5-way binding posts for all terminals • Low impedance drive from sweep coupling.

Complete, all tubes incl. 5" CR tube; illus. wiring & assembling, operating instructions. Wt. 20 lbs.

### SPECIFICATIONS VERTICAL

Freq. Resp. Actually useful to 4 mc.  
Max. Snst. 25 mv. per RMS inch  
Input Imp. 3.3 megohms across 30 mmfd.  
Amplifiers Video compensated

### HORIZONTAL

Actually useful to 700 kc.  
0.3 volts per RMS inch  
500,000 ohms across 35 mmfd.  
Non-parallax deflection type output

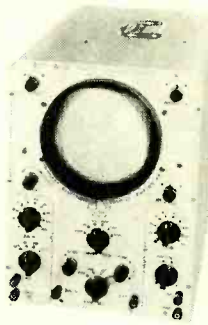

Kit Model 555K.....59.50 Factory wired complete.....89.50

## 327K Tube Tester Kit

Tests all tubes in all current radio & TV sets, also color TV—new 600 ma series string-type, etc. Has line voltage regulator—"free point" obsolescence-proof element switching system—short & leakage tests—can't insert tube in wrong socket—fuses protect meter & transformer separately. New loose leaf book with indexed tube data cards—no obsolescence—new tube data quickly inserted—far ahead of rollcharts. Picture Tube Adapter \$3.95

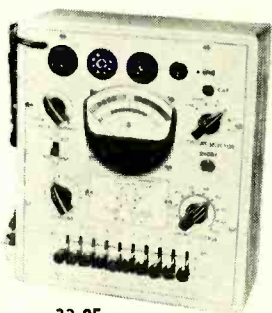

327K Kit Complete.....33.95  
327 Factory wired & tested.....48.95

## 480K Multi-Tester Kit

1000 ohms per volt. Measures DC volts—AC volts—DC amp.—DC milliamps.—ohms—megohms—decibels—output meter. Molded, bakelite panel, case, battery cradle—molded in jacks—circuitry design protects against meter damage—high sensitivity.



480K kit complete with battery and all parts.....12.75  
480 Factory wired and tested.....14.85

Get these kits from your distributor. Write for literature, Dept. RE-12

## GENERAL ELECTRONIC EQUIPMENT CO.

MANTUA AVE. and GLENDALE ST., EASTON, PA.

A Division of Radio City Products Co., Inc.

## NEW DEVICES

amplifier or TV inputs. 2 trimmer screws tune out interfering frequency. Rejection from 35 db at channel center to less

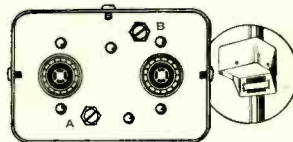

than 3 db 1.5 mc on either side. —Blonder-Tongue Labs., Inc., 526 North Ave., Westfield, N. J.

**GEIGER COUNTER, model AE100**, completely wired, includes all batteries and tube. Supersensitive, has 900-volt halogen quenching type Geiger tube to protect against burn-out. Detects presence of ura-



nium or other radioactive ores, minimum radiation harmful to health. *Model AEK100* (kit) includes batteries and tube, headphone and shoulder carrying strap.—General Electronics Equipment Co., Glendale & Mantua Sts., Easton, Pa.

**DUAL-PURPOSE SELENIUM RECTIFIER, type 60-9150**, voltage-doubler stack delivering 50 ma connected to maximum a.c. input of 175 volts r.m.s. 2 units connected as single-phase full-wave bridge circuit delivers approximately 180 volts d.c. at 0.1 amp for r.m.s. voltage input of 230. Output of 350 volts d.c.

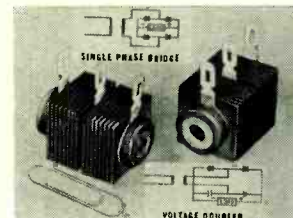

obtainable. For remote TV tuners where hum is objectionable; solenoids, variable-speed controls, field supplies for small d.c. motors, etc. 21/32 x 1/16 x 1/4 inches overall. Mountable with No. 8 machine screw through hollow brass eyelet.—International Rectifier Corp., 1521 E. Grand Ave., El Segundo, Calif.

**VARIABLE CAPACITOR, MS-215**, for builder of transistorized and miniature equipment. Variable from 10 to 365  $\mu\text{f}$ . 3/16 inch thick by 1 1/2 inches



square. Bushing and shaft extend 3/8 inch; 180° rotation.—Lafayette Radio, 100 Sixth Ave., New York 13, N. Y.

**FUSE DISPENSER**, double or multiple channels. Single-channel dispensers available in 10-

All specifications given on these pages are from manufacturers' data.

(Continued)

channel package. Each channel can dispense 2 types of fuses, from middle and bottom. One 20-box channel with most popular selling fuses, 10 boxes



each of 1/4-amp and 1/2-amp 3 AG's.—Littelfuse, Inc., 1865 Miner St., Des Plaines, Ill.

**HAND REAMERS, 1/2 to 3/8 inch** in wood, plastic and sheet metal. Chrome finish keeps cutting edges sharp and rust-free. No. 38 (top) fixed in 1 x 3 7/8-inch plastic handle. No. 99-38 fits handle in No. 99 multipur-

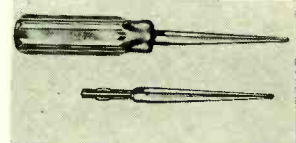

pose tool kit. Kit No. 99 has 13 detachable nut-driver and screw-driver bits. Extra pocket stores No. 99-38 reamer.—Xcelite, Inc., Orchard Park, N. Y.

**PREAMPLIFIER-AMPLIFIER, Prelude model PC-200**, uses printed circuits. 100 watts output. Preamplifier inputs for phono and tuner, tape input for



correct preamplifier equalization for tape recorder heads. Tape output unaffected by tone controls.—Harman-Kardon, Inc., Westbury, L. I., N. Y.

**CLEANER AND LUBRICATOR, Trol-Gun and Trol-Kleener**, Trol-Gun loaded like fountain pen. Fits over set's volume control shaft. Tool's piston forces cleaner-solvent into area around shaft. Trol-Kleener recommended for use with the gun. Both can be used on pushbuttons, switch contacts and tuners.—General Cement Mfg. Co., 400 S. Wyman St., Rockford, Ill. END

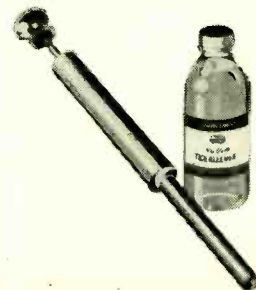

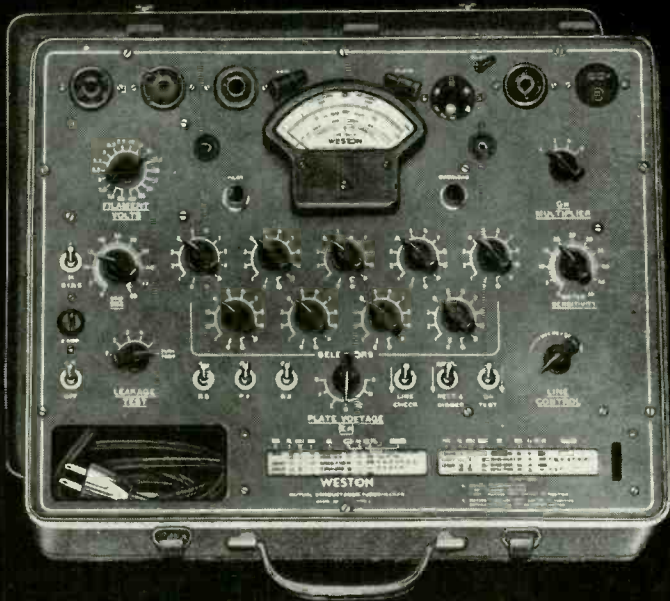

Weston Model 981  
Proportional Mutual Conductance Tubechecker

# FILTERED D-C POTENTIALS

for accurate  
 $G_m$   
measurements

## OUTSTANDING FEATURES:

**$G_m$  MEASUREMENTS**— $G_m$  measurements are made more accurately by using filtered d-c plate, screen grid and control grid potentials. A precision voltage divider network and selector switch allows a proportionate value of signal voltage to be chosen for testing tubes having transconductances up to 30,000 micromhos. Signal voltages of 5.2, 2.6, 1.3, and 0.65 volts peak-to-peak having a frequency of 5000 cycles are provided.

**GRID BIAS, SCREEN GRID AND PLATE VOLTAGE:** Filtered d-c potentials of 90, 130, and 220 volts are available for plate and screen potentials. A variable filtered d-c voltage in two ranges of 0-5 and 0-20 volts are used to obtain better resolution of Grid Bias settings. *Far greater accuracy is obtainable with filtered d-c potentials than previously possible in portable tubecheckers.*

**METER MEASUREMENT OF HIGH LEAKAGE RESISTANCE**—Since tube leakage as high as several megohms can cause poor performance in TV Receivers, this tubechecker is designed to provide an accurate meter measurement of leakage resistance as high as 5 megohms between tube elements, thus being particularly useful for TV servicing and TV line production assembly.

**TWIN SECTION TUBES**—Three toggle switches make it possible to rapidly check and compare the respective sections of twin section tubes at only one setting of the selector switches.

**WESTON** 980 LINE  
TEST EQUIPMENT

THE  
**980**  
LINE

PROPORTIONAL  
MUTUAL  
CONDUCTANCE  
**TUBECHICKER**

SEND COUPON TODAY FOR  
COMPLETE DESCRIPTION AND PRICES

Weston Electrical Instrument Corporation  
614 Frelinghuysen Avenue  
Newark 5, New Jersey

Please send literature on the new 981 Tubechecker.

NAME \_\_\_\_\_

ADDRESS \_\_\_\_\_

# LOOK FOR THIS LABEL

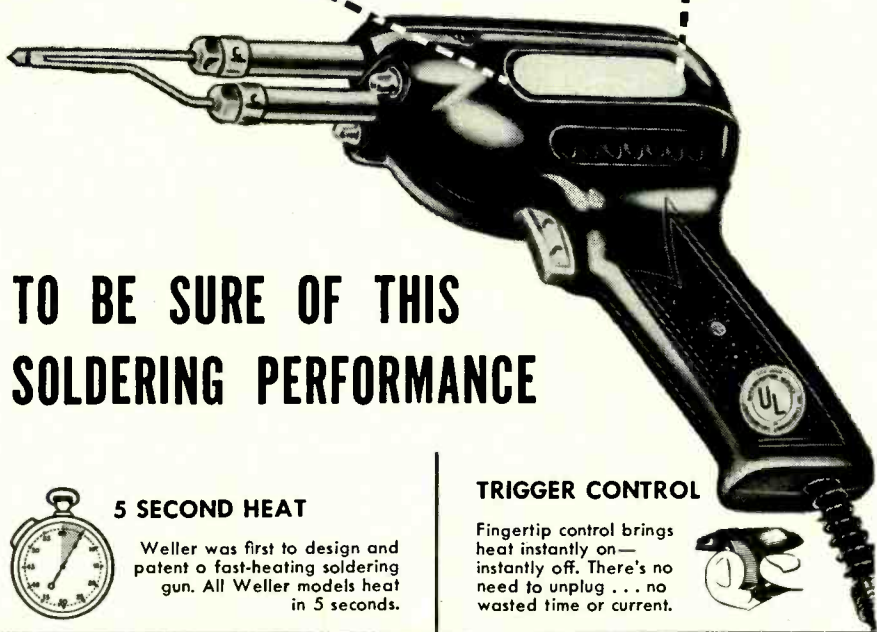

## TO BE SURE OF THIS SOLDERING PERFORMANCE



### 5 SECOND HEAT

Weller was first to design and patent a fast-heating soldering gun. All Weller models heat in 5 seconds.

### TRIGGER CONTROL

Fingertip control brings heat instantly on— instantly off. There's no need to unplug . . . no wasted time or current.



### PERFECT BALANCE

The exclusive streamlined-design of Weller Guns permits easy access to tight places, comfortable handling and precision soldering.

### EXCLUSIVE TIP-GRIP

Wiping action of tip-fastening nuts eliminates contact resistance and oxidation. Full, constant heat is assured.

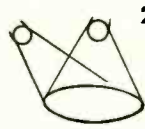

### 2 SPOTLIGHTS

Pre-focused dual spotlights eliminate shadows and illuminate the work. Lights and heat come on simultaneously.

### LONG-LIFE TIPS

Low cost Wellertips give long service, are designed for maximum heat transfer and can be changed in seconds.



# Weller

ask your distributor for a demonstration

**ELECTRIC CORP.**

822 Packer Street, Easton, Pa.

## new Tubes & Transistors

### Germanium transistors

Four new types of germanium n-p-n transistors have been announced by Texas Instruments. The 2N124, 2N125, 2N126 and 2N127 are especially designed for general-purpose switching and computer applications. The units feature a beta spread of 2 to 1: 12 to 24, 24 to 48, 48 to 100 and 100 to 200, respectively. Because of their excellent rise-time and cutoff characteristics they can be used in high-speed switching circuits. Rise time in a typical circuit is 0.15  $\mu$ sec; cutoff time is 3.5  $\mu$ sec.

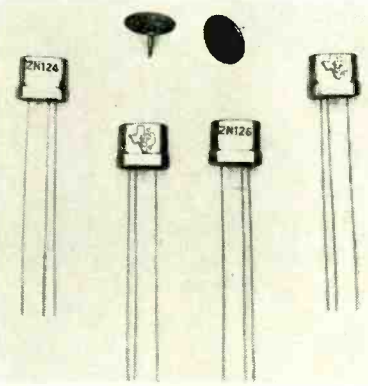

The absolute maximum ratings of these transistors at 30° C are as follows: collector voltage, 10; emitter reverse voltage, 5; collector current, 8 ma; emitter current, -8 ma; collector dissipation, 50 mw.

### 2N115

Amperex has announced a p-n-p junction power transistor, the 2N115 (see photo), that delivers 5 watts push-pull output with a 6-volt supply. The output impedance of the 2N115 is low enough



for a 5-ohm speaker voice coil to be used directly as the collector load in an audio output stage and is ideal for operation in car radios having 6-volt systems.

### 6521 Magnetron

Intended for use as a pulsed oscil-

RADIO-ELECTRONICS

## AIREX THE ELECTRONICS SUPERMARKET

RECORD CHANGER BASES & BOARDS  
Bases—\$3.49 Mounting Boards—\$1.87  
Webster — Garrard — Collaro. Give model.

TRIPLE PLAY CARTRIDGE TYPE GE RPX050 \$5.86

45 RPM SPINDLES  
GARRARD . . . \$2.99  
WEBSTER . . . \$3.89  
COLLARO . . . \$3.79

FREE CATALOG of latest hi-fi equipment sent upon request

## TOP MERCHANDISE AT ROCK BOTTOM PRICES

WEBSTER MDL 140: 3 speed intermix, automatic shutoff, dual styli cart. 2 pole motor. \$22.95  
Reg. \$37.50

WEBSTER MDL 140 GE: 3 speed intermix, with GE reluctance RPX 050 cart, dual sapphire styli, automatic shutoff, 4-pole motor. Reg. \$40.00 \$26.95

GARRARD RC 80: 3 speed, weighted turntable, 4 pole motor, automatic shutoff, with heads, line cord & plug. Reg. \$49.50 \$42.95

COLLARO RC 54: 3 speed intermix, automatic shutoff, weighted turntable, plug-in head with 4-pole motor. Reg. \$48.75 \$37.50

With Ronette Dual Saph Styli Hi-Fi Cart \$39.95

All merchandise is brand new, factory fresh & guaranteed. Mail & phone orders filled on receipt of certified check or MO of 20% of items as a deposit. Balance C.O.D., F.O.B. factory N. Y. Prices & specifications subject to change without notice.

AIREX RADIO CORP., 171 Washington St., N. Y. 7

CO 7-5218

NEW TUBES & TRANSISTORS (Continued)  
 lator at 5,400 mc in weather radar equipment, the 6521 (see photo) operates with high efficiency at pulse durations to 2.2 microseconds and has a maximum peak input power rating of 256 kw, a maximum peak anode voltage rating of 16 kv and a peak anode current rating of 10 to 16 amperes.

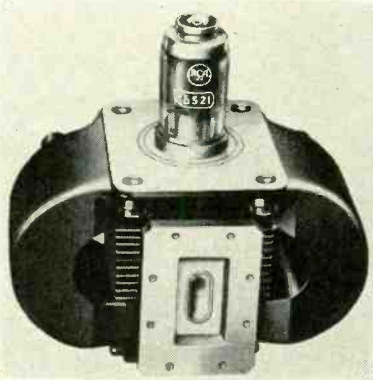

When operated at a peak anode current of 13.5 amperes, corresponding to a peak anode voltage of about 15 kv, the 6521 is capable of a peak power output of approximately 85 kw. The tube was announced by RCA.

**6CH7**

Information on this miniature medium-mu twin-triode designed for v.h.f. cascode amplifier applications was given in our November column. Further data

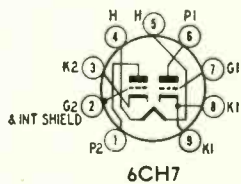

gives the basing connections (see diagram). Because of the connection of the internal shield, section 1 (pins 6, 7, 8 and 9) must be used as the input or grounded-cathode section. Except for basing, it is identical to the 6BZ7.

**6BY4**

A ceramic high-mu triode of parallel-plane construction, the 6BY4 (see diagram), has been announced by G-E. Designed primarily for use as a grounded-grid r.f. amplifier in u.h.f.-v.h.f. TV receivers, this micro-mini-

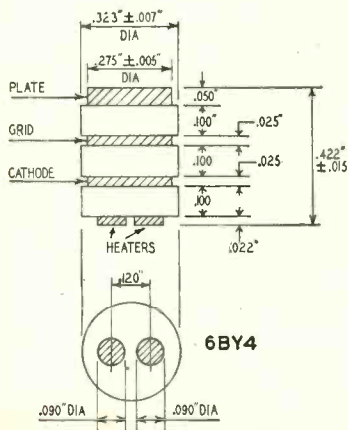

**ATTENTION!**  
 SCHOOLS, HOBBYISTS,  
 RADIO TECHNICIANS!

**CATHODE RAY  
 SCOPE TUBE**

3API, made by famous tube maker - Jan type! Electrostatic focus and deflection. Medium 7 pin base. Individually cartoned. Packed for export.  
 Regular net \$15.75.

**Rad Tel TUBE CO.**

**79c** ea. Lots of 4 individ. packed 4 to a carton

**SINGLE 99¢ EA.**  
 Send for FREE catalog RE-12 with over 400 tube types at savings!

**115 COIT ST., IRVINGTON 11, N. J.**

**RT-24/APX-2  
 IFF EQUIPMENT**

44 tube transceiver with usable parts, tube sockets, relays, coax fittings, condensers, resistors, etc. 24 volt Blower motor, 24v gear train motor. Power transformer 400 to 2400 cycles. Original govt. cost \$750.00 Less tubes \$5.95 ea.

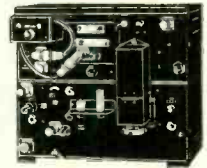

Shipping weight 26 lbs.

**SPECIAL**

Same RT-24/APX-2 in sealed overseas carton complete with 44 tubes: 1-6AG5; 19-6C4; 1-OD3-VR150; 1-2C26; 7-6J6; 4-9006; 1-5Y3; 1-2D21.  
 List price of tubes alone \$80.00. Ship by railway only. Approx. weight 30 lbs.

**\$17.95 each**  
**Lots of 3 \$16.95 ea.**

**COYNE**  
 trains you for  
 big pay jobs  
 in...

*You Can Quickly  
 be doing interesting  
 profitable work  
 like this!*

**TELEVISION**  
 -RADIO in shops of COYNE  
 ...or in  
 spare time at HOME

A fascinating field! A great future! A good job or independence in a business of your own! TV is growing by leaps and bounds - 1227 new communities, 1845 new stations given "go-ahead", Trained men are worth their weight in gold!

**COYNE HAS TRAINED MORE  
 SUCCESSFUL MEN**

Thousands of successful men trained at COYNE - the largest, oldest, best-equipped school of its kind (established 1899). A Coyne-trained man is a top-trained man. Coyne methods require no advanced education or previous experience.

**TRAINING TAILORED TO  
 MEET YOUR NEEDS**

**Resident Shop Training**—You can learn on real equipment in the Great Shops of Coyne. Learn quickly-easily at Coyne. Practical Technical method gives practical experience on massive outlay of full-size equipment plus necessary technical training. Finance Plan whereby you can enroll now and pay most of tuition later. Also Monthly Payment Plan especially designed for K-Vets. If you need part-time work to help out with living expenses while at COYNE, we'll help you get it. Coupon brings FREE BOOK and details.

**OR**

**Coyne Tested Home Training**—To those who cannot come to the Coyne shops here in Chicago, we offer modern, up-to-the-minute training designed to meet Coyne standards. Practical, down-to-earth, easy to follow, step-by-step instruction. So practical, you can quickly be earning money in

**B. W. COOKE, President**      **FOUNDED 1899**

**COYNE ELECTRICAL SCHOOL**  
 A TECHNICAL TRADE INSTITUTE CHARTERED  
 NOT FOR PROFIT  
 500 S. Paulina Street, Chicago 12, Dept. 95-TR4  
 ELECTRICITY • RADIO • TELEVISION • REFRIGERATION • ELECTRONICS

Television and Radio while learning—personal supervision by Coyne Staff—men who know TELEVISION AND RADIO, AND KNOW HOW TO TEACH IT—and the cost is low—you pay only for training—no costly extras. Send coupon below for Picture Folder and full details, including easy Payment Plan.

**MAIL COUPON FOR  
 FREE INFORMATION**

Fill in and mail coupon, TODAY. Check the training you're interested in. If you want information on both, check both. Complete details will come by return mail. No cost—No obligation—No salesman will call.



**B. W. COOKE, President**  
**COYNE ELECTRICAL SCHOOL**  
 500 S. Paulina Street, Chicago 12  
 Dept. 95-TR4

Send details of your offer on training checked below. This does not obligate me and no salesman will call. I am interested in:

TELEVISION-RADIO HOME TRAINING  
 TELEVISION-RADIO IN COYNE SHOPS

Name .....

Address .....

City.....State.....

# Gives your customers brilliant results ...pays off for you!

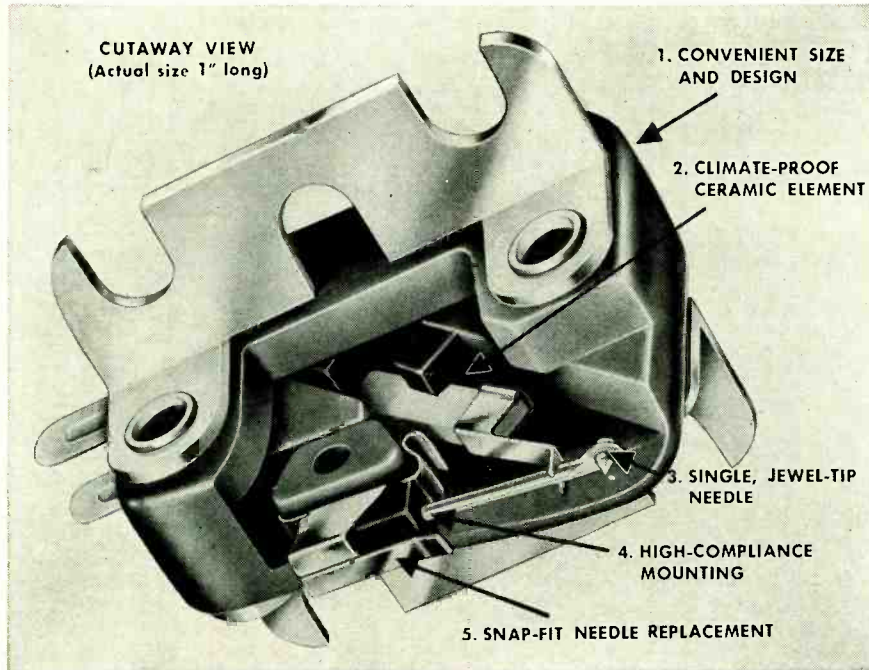

## New Sonotone 1P Cartridge

1. Easy to install. Just two models fit most arms now in use. Cartridge is less than 1" long, 8/10" wide with bracket. Time-saving hardware included.
2. Ceramic element gives flat response (see curve) — requires no preamplification or equalization. No deterioration problems as with other types... virtually immune to hum pickup.
3. Replaceable needle, diamond or sapphire. Models for 33-45 rpm, or 78 rpm.
4. Extreme lateral compliance and low-mass design give superior tracking, low wear.
5. Needles snap in, snap out easily.

### Tap the Huge 45 RPM Changer Market!

Install this new Sonotone 1P, and give your customers exciting, true, wide-range response. At one stroke, you make a good sale, cut installation time, avoid problems found with other types of cartridges... and build your reputation for quality work and professional advice. No other cartridge has all the advantages this 1P gives you! With sapphire, \$7.50; with diamond, \$25.00.

RESPONSE 30-15,000  $\pm$  3 DB!

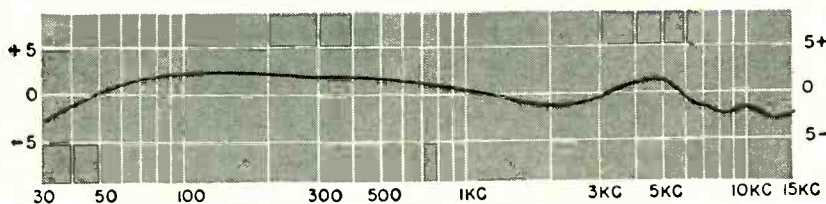

**SONOTONE**<sup>®</sup> CORPORATION  
ELMSFORD, N. Y.

Write Dept. CE-125 for free Phono Modernization Manual

#### NEW TUBES & TRANSISTORS (Continued)

ature tube is of metal-ceramic construction. This gives it several advantages over glass receiving tubes—operation at higher temperatures, greater resistance to mechanical shock and vibration, low microphonic output.

Operating at 900 mc, the 6BY4 provides a power gain of approximately 15 db and a noise factor of approximately 8.5 db with a 10-mc bandwidth. Thus the tube can operate as an r.f. amplifier for both v.h.f. and u.h.f. in TV tuners. Maximum ratings for the 6BY4 are: plate voltage, 300; positive d.c. grid voltage, 0; plate dissipation, 1.1 watts; d.c. cathode current, 5.5 milliamperes.

Operating as a typical class-A<sub>1</sub> amplifier the 6BY4 has an amplification factor of 100, a plate resistance of 16,700 ohms, a transconductance of 6,000 micromhos. Heater voltage is 6.3 at 250 ma. Plate voltage in this application may be 200, plate current 5 ma and grid bias -1 volt. **END**

#### CORRECTIONS

Through a fantastic printer's error in the coil table for the preselector on page 141 of the October issue, in the fourth column, labeled "Taps from Ground," data for the 160-meter coil was erroneously transposed with that for the coil used on 15, 11 and 10 meters. Similarly, the data for the 80- and 20-meter coils is transposed in this column.

Our thanks to Preston A. Taylor of Elnora, Ind. for catching this error in the coil data.

As the result of an error in "Circuit Features in Hi-Fi Power Amplifiers" in the September issue, a 6A7-G is suggested on page 79 for V1 and V2 in Fig. 5. The tube type should be a 6AS7-G.

#### Radio Thirty-Five Years Ago In Gernsback Publications

HUGO GERNSBACK Founder	
Modern Electrics .....	1908
Wireless Association of America .....	1908
Electrical Experimenter .....	1913
Radio News .....	1919
Science & Invention .....	1920
Television .....	1927
Radio-Craft .....	1929
Short-Wave Craft .....	1930
Television News .....	1931

Some of the larger libraries still have copies of ELECTRICAL EXPERIMENTER on file for interested readers.

#### In December 1921 Science and Invention (formerly Electrical Experimenter)

- A New Color-Music Instrument, by Edwin Haynes.
- Perfectly Synchronized Talking Movies, by Joseph H. Kraus.
- Learn and Work While You Sleep, by H. Gernsback.
- Invisible Ray Signaling.
- Radio in a Nutshell.
- The World's Series by Radiophone, by Arthur H. Lynch.
- A Short-Wave Regenerative Set, by William H. Grace, Jr.



# Patents



## V.T.V.M.

Patent No. 2,713,663

John R. Crabbe, Bayside, N. Y. (Assigned to Servo Corp. of America)

Most v.t.v.m. circuits specify two similar tubes in a balanced-bridge arrangement. One reason for this requirement is the need for linear response. The same result may be obtained with a single voltmeter tube if it is biased at a

voltmeter tube). If the input also has a d.c. component, switch S is thrown to cut in a blocking capacitor C.

V2 is a cathode follower with load R1. This resistor develops a potential equal to that across

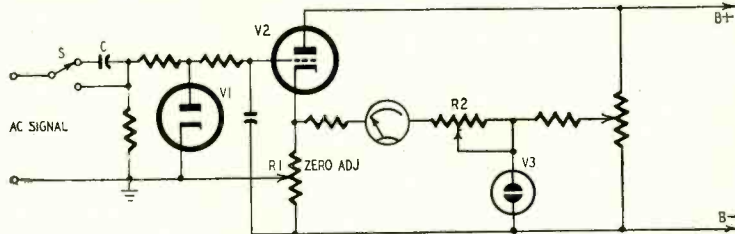

linear portion of its characteristic. This is done here.

The diagram shows an a.c. voltmeter with V1 rectifying the signal. After filtering, a negative voltage is delivered to V2 (the d.c. amplifier or

the neon lamp V3. Therefore the meter does not deflect when the signal is zero. The reading increases with signal input because V2 passes less current and unbalances the meter network. R2 controls sensitivity.

## TRANSISTOR CONVERTER

Patent No. 2,713,117

Rowland W. Haegle, Bayside, N. Y. (Assigned to Sylvania Electric Products, Inc.)

Useful for mixer and converter service, this tetrode transistor has three point contacts closely spaced on the semiconductor to form a triangle. One is treated to become a collector, the others are emitters.

The diagram shows a local oscillator and mixer circuit for use in a superheterodyne radio. L-C is the tuned circuit in an oscillator consisting of the collector, emitter E2 and the base. The broadcast signal appears at emitter E1 and the oscillator signal at E2. These frequencies mix within the semiconductor and the beat is passed by the collector into the output i.f. transformer.

As usual, each emitter is biased to a fraction

of a volt positive. The collector battery may be about 22-40 volts negative.

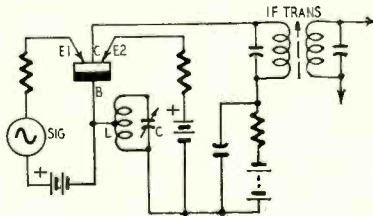

## COLD LIGHT

Patent No. 2,709,765

Lewis R. Koller, Schenectady, N. Y. (Assigned to General Electric Co.)

This is an efficient source of cold light. The diagram shows an elementary form of the invention. The base is a plate of glass or other

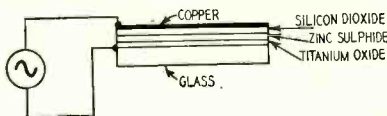

transparent material. Upon this is placed a thin film of titanium dioxide, a conductor, then a thicker layer of zinc sulfide. The next layer is silicon, a nonconductor converted to an oxide state. The top layer is a conductive coating of copper or silver.

When a.c. is applied across the top and bottom layers, the zinc sulfide emits light without heat. Brightness increases exponentially with the a.c. voltage.

## INTRUDER ALARM

Patent No. 2,708,746

Joseph D. Shaw, Cincinnati, Ohio

This alarm indicates the movement of persons or objects. Its special feature is an automatic reset. For example, if a person enters a restricted area, an alarm will sound and in a short time the instrument is ready for operation again. Departure of a person can be indicated by a different alarm.

The block diagram shows how the device functions. The oscillator feeds energy to an antenna over an area to be guarded. When a person approaches he automatically increases the capacitance of the network so the oscillator frequency drops. The discriminator (originally set

for zero output) delivers voltage to a relay circuit, causing the alarm to sound.

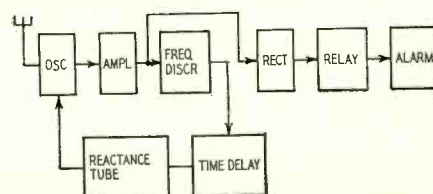

don't do it  
the hard way!



USE A



## ROTARY CABLE STRIPPER

Model S-1

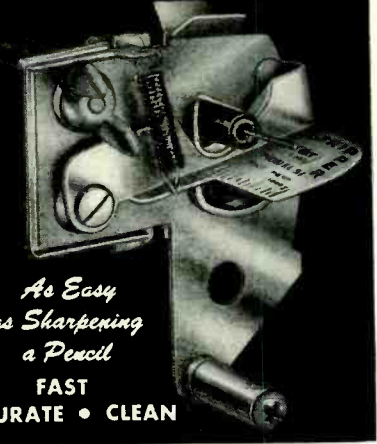

As Easy  
as Sharpening  
a Pencil

FAST  
ACCURATE • CLEAN

and Practically **AUTOMATIC**

- ➔ Cuts and strips the outer covering of coax cable without injuring the shielding.
- ➔ Cuts the shielding without pulling, fraying or unbraiding.
- ➔ Cuts and strips the inner insulation and . . .
- ➔ Measures just the right length of lead desired.
- ➔ Ideal for stripping all insulated wire and cable — as well as non-metallic tubing.

— and its **ONLY \$375** LIST

A Must For Your Kit —  
Get One Today

at your Parts Distributor.

**BLONDER-TONGUE LABORATORIES, INC.**

Dept. JM-3, Westfield, New Jersey



Manufacturers of TV Cameras,  
TV Amplifiers, Boosters,  
UHF Converters, TV Accessories  
and Originators of the Masterline  
and 'Add-A-Unit'  
Master TV Systems.

# DON'T THROW OLD RADIOS AWAY!



Let this big  
handbook show you  
EXACTLY HOW TO  
FIX THEM

fast and r-i-g-h-t!



## THE ONLY GUIDE OF ITS KIND!

**A. A. GHIRARDI**  
Covers every model  
made by 202 mfrs.  
from 1925 to 1942

- Airline • Apex
  - Amrad • Arvin
  - Atwater Kent
  - Belmont
  - Bosch
  - Brunswick
  - Colonial
  - Columbia
  - Clarion
  - Crosley
  - Echophone
  - Emerson
  - Eveready
  - Fada • G.-E.
  - Freed-Eisemann
  - Lytic
  - Kolster
  - Majestic
  - Motorola
  - Philco • Pilot
  - RCA
  - Silvertone
  - Sparton
  - Stewart-Warner
  - Stromberg
  - Wells-Gardner
- ...and over a  
hundred more!

There's a "secret" to fixing old radios fast and profitably... and Ghirardi's big 744-page, manual-size **RADIO TROUBLESHOOTER'S HANDBOOK** is it!

No other guide like it! Gives common trouble symptoms and remedies for over 4,800 models of old home receivers, auto radios and record changers. Contains tube and component data, charts, circuits, etc. available from no other source.

Even beginners can handle jobs slick as a whistle. Makes it easy to repair old sets for which specifications and how-to-fix-it data are no longer available. Just look up the model you want to fix. Four times out of 5, this giant Handbook leads you right to the trouble... shows exactly how to fix it. No useless testing. No guesswork. You repair sets in a jiffy that would otherwise go to the junk pile because no one knows what to do with them.

There are over 400 pages of troubleshooting and service case histories. In addition, you get over 300 pages of helpful I-F transformer data; superhet realignment data and alignment peaks; handy troubleshooting reminder charts; auto radio gear ratios; complete data and characteristics on old tube types and components; tube substitution data... and dozens of other invaluable service tips and ideas.

### PRACTICE 10 DAYS FREE

Dept. RE-125, RINEHART & CO., INC.  
232 Madison Ave., New York 16, N.Y.

Send Ghirardi's RADIO TROUBLESHOOTERS HANDBOOK for 10-day free examination. If I decide to keep book, I will then send \$6.50 (plus post-ages) in full payment. Otherwise, I will return book postpaid and owe you nothing.

Name.....  
Address.....  
City, Zone, State.....  
O! T! S! I! D! E! U! S! A! \$7.00 cash only. Money back if book is returned in 10 days.

Rinehart Books are sold by  
leading book stores

## PATENTS

(Continued)

Voltage also reaches the reactance tube through a time-delay circuit. This tunes the oscillator to rebalance the discriminator. The time delay permits sounding the alarm before the oscillator is retuned.

If another person arrives, a second alarm will sound. When a person departs, the discriminator is unbalanced in the opposite direction. If desired, this can sound a different alarm.

Instead of audible alarms, counters may be used at the output. This makes it possible to tally the number of people arriving and leaving.

## COMPACT LOOP ANTENNA

Patent No. 2,702,860

Walter Farbanish, Chicago, Ill. (Assigned to Zenith Radio Corp.)

In the early days of radio, nothing less than 50 or 100 feet of wire could be used to bring in radio programs. As receiver sensitivity increased, shorter antennas became practical. The introduction of ferrite antenna coils changed all this, for it permitted remarkable pickup with a small coil. This invention is an improvement over existing coils.

Conventional coils have cylindrical cores which must be moved in or out of the coil for tuning.

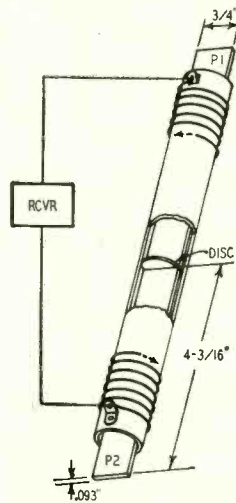

This means that added space must be available when the core is withdrawn. The new idea is to use two flat cores—one fixed, the other rotatable. They are isolated by a thin disc as shown. When the cores are in the same plane, loop inductance is maximum; when perpendicular, the inductance is much lower.

Typical dimensions are given in the diagram. The coil may have 89 turns of litz wire, with maximum inductance 265  $\mu$ h. END



My card, Madame!"

## !!! Warehouse Clearance Sale !!!

### Must Vacate 30,000 Sq. Feet !!!

#### PRICES SLASHED! • • • EVERYTHING GOES!!

Thousands of NEW & VALUABLE ELECTRONIC COMPONENTS ARE BEING "DUMPED" INTO OUR NATIONALLY FAMOUS

### "JUMBO RADIO-ELECTRONICS PARTS KIT"



We save on moving the stuff... YOU GET 17 check-full lbs. of new & surplus: CONTROLS, SWITCHES, WIRE, SOCKETS, COILS, SAMS' PHOTOFACTS, CAPACITORS, HANDWARE, NIBS PLUS DOZENS & DOZENS MORE ITEMS (shpg. wt. 20 lbs.)

**\$3.95**

### Speaker Repair Parts & Kits... Do-It-Yourself!

Replacement Cone & Voice Coil Assemblies for EVERY TYPE OF SPEAKER. Here are just a few popular assemblies to fit: Philco, Emerson, RCA, Zenith, Utah, etc. speakers: (Please specify O.D., I.D. & depth on order)

4" or 5"	\$1.10	10"	\$2.50
5" or 4x6"	1.45	12"	3.00 up
5x7", 7", 8"	1.70	15"	4.50 up
6"x8"	1.80		

Kit "A"—REPLACEMENT CONE KIT... An assortment of popular sizes 4" to 12" incl. oval, Less voice coils. Kit of 12 assorted..... \$1.98

Kit "B"—DE LUXE CONE KIT... same as above, but containing larger variety of 20 cones..... 2.98

Kit "C"—SPEAKER REPAIR KIT... Professional assortment of: Rings, Spiders, Voice Coils, Forms, Felt, Chamois Lthr, Shim Kit, Cement & Instructions..... 2.49

!!SPECIAL!!... BOTH KITS "A" & "C" FOR ONLY..... 3.95

### \*\*BUY OF THE MONTH... MIDGET OVAL PM SPEAKER

(134"x234"). Just the thing for Transistor or the smallest Personal set. WHILE THEY LAST \$1.98

**RADIO CEMENT & SOLVENT KIT**... 4 oz. bottle of each with applicator brush. KIT. .98

**PHOTOELECTRIC CELL**... Sensitive Selenium. Wood cased. 2 1/2"x3/4" x24"..... 98¢

**RG-8/U CO-AX CABLE**... 20 ft. (RHT)..... 1.49

**3 TUBE PHONO AMPLIFIER KIT (AC-OC)**... Includes all parts: Wire Solder, Diagram & Lvt. Chassis. Less tubes..... \$2.49

Set of 3 tubes for above..... \$1.69

### G.I. RECORDER MOTOR (RM4 type)

Used in most TAPE, WIRE & DISC RECORDERS. 1740 RPM; silent operating. 5/16" shaft; 33/8" sq. 823/4" deep. Less mtg. plate assy. 115V AC \$4.95

**PHOSPHOR BRONZE DIAL CABLE** for TV & Radio. Braided over cotton core. 56 ft. 100 ft. \$3.75

**CHANGER MTC. SPRINGS**... conical ea. \$c 15/\$1.00

**SPRING KIT**... dial, tension, compress. 25 asstd. 98

### TV-RADIO BUILDERS LIBRARY

A "Gold-Mine" of TV, Radio, S.W., etc. diagrams, incl. Sams' Photofacts. Kit of 25 assorted..... 98

**IIXMAS SPECIAL!!... POWER RHEOSTAT**... 25W-250 Ohms... 1/4" shaft. Center tap. BRAND NEW..... ea. 49c 12/\$5.00

**HI-FI HEADPHONES**... Wide freq. response. Baffle. lite cone & voice coil. Sponge rubber cushions & cord..... 2.95

Min. Order \$3.00—20% Deposit Req. on all COD's. Please add sufficient postage—excess refunded.

# LEOTONE RADIO CORP.

67 Day Street  
New York 7, N. Y.

## INVENTORS

Send for REGISTERED PATENT ATTORNEY

Book and INVENTORS RECORD without obligation

GUSTAVE MILLER Patent Attorney & Advisor U.S. Navy Dept. 1930-1947

RE-125 WARNER BUILDING WASHINGTON 4, D. C. PATENT LAWYER

## EASY TO LEARN CODE

It is easy to learn or increase speed with an Instructograph Code Teacher. Affords the quickest and most practical method yet developed. For beginners or advanced students. Available tapes from beginner's alphabet to typical messages on all subjects. Speed range 5 to 40 WPM. Always ready—no QRM.

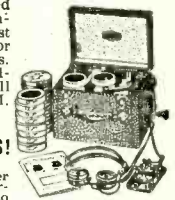

### ENDORSED BY THOUSANDS!

The Instructograph Code Teacher literally takes the place of an operator-instructor and enables anyone to learn and master code without further assistance. Thousands of successful operators have "acquired the code" with the Instructograph System. Write today for convenient rental and purchase plans.

## INSTRUCTOGRAPH COMPANY

4701 Sheridan Rd., Dept. RC, Chicago 40, Ill.

RADIO-ELECTRONICS

# radio-electronic Circuits

## VOLUME COMPENSATOR

Many of us are annoyed by radio and TV commercials that are several db louder than the average program level. At least one circuit has been developed to limit commercials to a comfortable level. See "Dual-Purpose Limiter Amplifier" in the October, 1954, issue.

A somewhat similar problem some-

R1-C1) greatly attenuates all frequencies above about 200 cycles and a highpass filter (C4-R4 and C3-R3) cuts off all frequencies below about 1,000 cycles. The outputs of the filters are passed through 1-megohm decoupling resistors and fed to a diode.

This diode rectifies the signal and

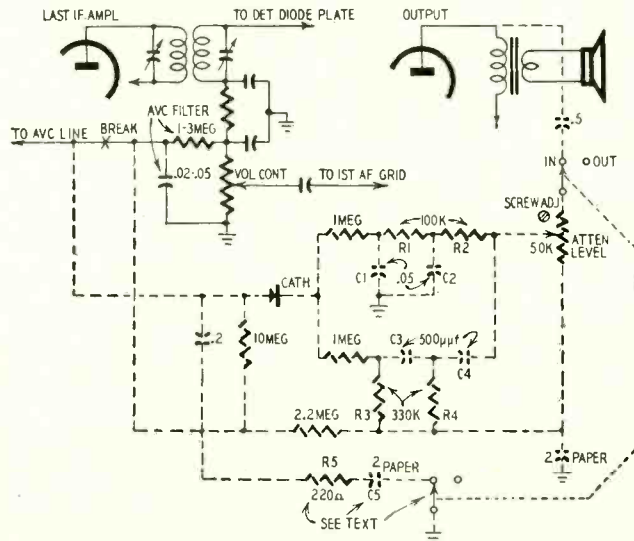

times exists during broadcasts of live concerts. In this case the voice of the announcer or commentator is lower than the program. This seems to be fairly common in Britain because several British publications have described circuits for equalizing the volume levels of speech and music. This experimental circuit, from *The Radio Constructor*, operates by developing an additional a.v.c. bias voltage when the audio output contains a large proportion of frequencies outside the normal speech range so the music is reduced to the level of the accompanying speech.

The diagram shows the circuit as added to a conventional receiver with a.v.c. The original receiver components are shown in solid lines and the added components in dashed lines. A part of the signal appearing at the power amplifier plate is tapped off and fed through a blocking capacitor to a 50,000-ohm potentiometer. The signal at the arm of this control is applied to two parallel-connected filters. The two-section low-pass filter (R2-C2 and

charges the 0.2- $\mu$ f capacitor to a negative voltage that depends on the amplitudes of the signals passed by the filters. This voltage is applied to the a.v.c. line in series with the a.v.c. voltage obtained by rectifying the carrier. Most speech power is in frequencies between 100 and 1,000 cycles so during announcements the rectifier output is low and volume is normal. During the musical portion of the broadcast the signal voltages passed by the filter are greater and a higher a.v.c. voltage is developed so the music volume level is lowered.

The 0.2- $\mu$ f capacitor and the 2.2- and 10-megohm resistors should be mounted close to the a.v.c. filter in the set. In some sets, filtering may not be sufficient to prevent instability at low audio frequencies. In this case, R5, C5 and a switch section should be connected as shown. When this circuit is used, it greatly increases the time constant of the a.v.c. filter but this does not matter because the circuit is designed primarily for local reception.

## TUBE BALANCING CIRCUIT

Several methods have been devised for static balancing of tubes in push-pull circuits. In voltage amplifiers, one common method is to feed the input

ends of the plate load resistors from the opposite ends of a potentiometer with the B plus line tied to the movable arm. A second balancing system has

Problem:

2 TV Sets

1 Antenna

Answer:



## 2-SET COUPLER

Model TV-42

Approved for Color TV  
UHF, VHF and FM



Cost: ONLY \$2<sup>95</sup> LIST

## Features:

- Matched resistive circuit
- Flat response—0 to 900 megacycles
- 12db inter-set isolation
- Easy to install
- Couples 2 TV sets without ghost or smear

## Application:

In class A signal areas the B-T 2-Set Coupler provides the ideal low cost solution to the problem of operating two receivers from one antenna. There are other applications. For example, the TV-42 can couple a TV set and FM receiver to one antenna—or it can be used, in reverse, to couple or mix 2 antennas to one receiver.

Write for FREE BOOKLET—"TV for 2 or 3... or More"  
Covers all types of Multiple TV Systems

Sold by Radio-TV Parts Distributors and Jobbers

BLONDER-TONGUE LABORATORIES, INC.

Dept. LM-3 Westfield, New Jersey



Manufacturers of TV Cameras,  
TV Amplifiers, Boosters,  
UHF Converters, TV Accessories  
and Originators of the Masterline  
and 'Add-A-Unit' Master TV Systems.

# Sangamo wire lead mica capacitors



Now!

## Packaged for your convenience!

Save time—do away with the cluttered mess of tangled wire leads. Use Sangamo Mica Capacitors, now mounted on space-saving cards.

These high quality mica capacitors are the finest available anywhere—at any price. They are fabricated with carefully selected premium grade imported mica and are molded in Humidite for

unequaled moisture resistance. You can depend on these wire leads for completely trouble-free TV replacements.

Each card of five capacitors has capacity rating and wvdc clearly marked. Each card shows the new RTMA Standards and the new MIL-C-5-A color code.

Stock up now—see your Sangamo distributor, or write us.

High quality wire lead micas for trouble-free TV replacements

**SANGAMO  
ELECTRIC  
COMPANY**

MARION, ILLINOIS



SC55-12B

### RADIO-ELECTRONIC CIRCUITS (Continued)

the cathode biasing resistors connected to the ends of a potentiometer with the arm grounded.

In *Electronic Engineering* (London, England) R. E. Aitchison of the University of Sydney, Australia, points out that unbalance in static current in triodes of the same type is caused by differences in cathode emission. He recommends this circuit for balancing.

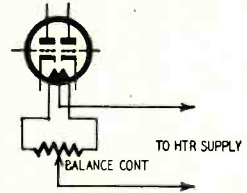

A potentiometer of a few ohms resistance is used to provide small variations in the voltage applied to the heaters. In a test batch of 50 12AX7's he found that the maximum difference in heater voltages required for balance was only 0.63 volt (10% of normal) while approximately half of those tested could be balanced with heater voltage differences of only 5%. The test also showed that when static current is balanced the mutual conductances of the tubes are nearly identical.

### SIMPLE VOLTAGE DOUBLER

One of the simplest and most practical arrangements of voltage-doubler power supplies is relatively unknown. It rarely appears in literature, even in the application handbooks prepared by manufacturers of selenium rectifiers.

The conventional half-wave doubler circuit is shown in Fig. 1. It is arranged

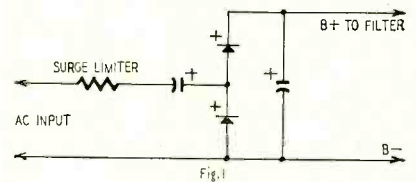

for continuity between B minus and one leg of the supply line, uses a resistor for surge protection and requires two independent electrolytics as well as any capacitor provided for additional filtering.

In designing instruments and accessories we usually find it necessary to

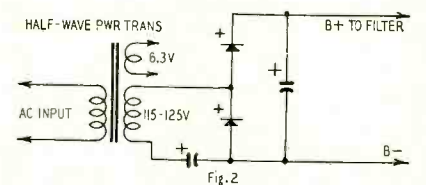

provide transformer isolation from the power line. This can be done by using one of the small half-wave transformers with 125-volt plate windings which are readily available.

The circuit can then be rearranged as in Fig. 2, at considerable advantage.

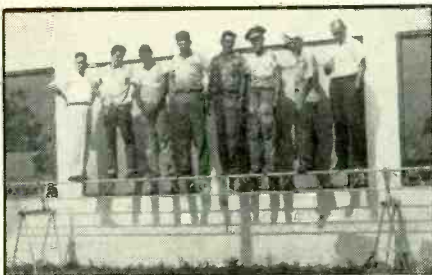

8 Men on a Horse

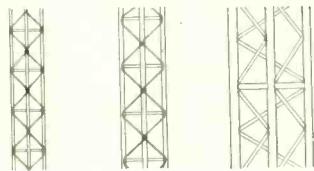

C-25

C-15

C-10

Here's proof of the strength of E-Z Way Towers. Photo shows C-10 tower section supporting 1200 pounds on horses 15 ft. apart. E-Z Way Towers are the sturdiest and most versatile in the industry. Write today for free catalog and price list. Catalogs available on Radio Broadcasting Towers, Communication Towers, TV Towers and Amateur Radio Towers. Please specify catalog you desire.

**E-Z WAY TOWERS Inc.**  
P. O. Box 5491 • Tampa, Fla.  
Phone • 4-3916

*buy and use*



**CHRISTMAS SEALS**

*fight tuberculosis*

**FREE!** a copy of "Forming Sheet Metal"



tells you how to make  
**CHASSIS - BRACKETS  
CHANNELS - BOXES**

with the A.B. Parker  
sheet metal folding machine

Write for your free copy plus our catalog of unusual tools - shears, riveters, notchers, punches. Ask for Catalog 36.

Telvac-1412 Great Northern Bldg.-Chicago 4, ILL.

RADIO-ELECTRONIC CIRCUITS (Continued)

The surge resistor is eliminated, since the d.c. resistance of the transformer is high enough to provide adequate protection. The input capacitor is transferred to the negative leg and combined with the output capacitor in a two-section unit with common negative.

This arrangement has the minor disadvantage that the transformer secondary is placed off ground by a d.c. voltage equal to its own peak charge on the input capacitor. This may be neglected in ordinary applications, however, as the transformer contains a tremendous margin of safety in its insulation.—Donald H. Rogers

**HEADPHONE DRIVER**

Have you ever desired a set of headphones for use with your audio system? They are a great convenience for late-hour listening, monitoring and many other purposes. Surplus 600-ohm headphones, available at moderate cost, have not been convenient to use because of their low impedance. The diagram shows a simple cathode-follower circuit which will drive such a set of

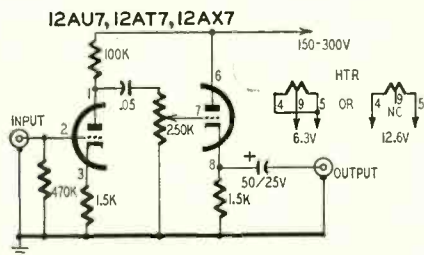

headphones with more than adequate volume and fidelity. For convenience, a single twin-triode tube is used. With a signal level of 0.3 volt or higher, a 12AU7 should be used; for lower signal levels, a 12AT7 or 12AX7. If a separate volume control is available at the signal source, the 250,000-ohm control may be replaced by a fixed 220,000-ohm resistor. The 470,000-ohm grid input resistor is large enough so as to offer negligible loading on virtually all amplifiers. The 50- $\mu$ f capacitor in the output presents a low reactance.—*Quentin J. Evans* END



"Which one of you guys has been shipping high-voltage condensers charged?"

**ALL-CLEAR TV PICTURES**

with the new

**B-T LABS ANTENNA BOOSTER**

(BROADBAND VHF)

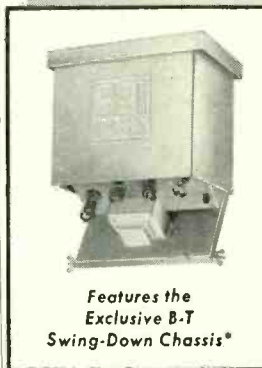

Features the Exclusive B-T Swing-Down Chassis\*

**MODEL AB**

- 4 TUBES
- 25DB GAIN
- \$95.00** LIST
- WITH MULTI VOLTAGE POWER SUPPLY

- Low-noise, all-triode circuit
- Easy mast-mounting
- Automatic 'on/off' from set
- 24 and 110v AC available plus step-ups for long-line drop
- Single lead line carries power 'up' and signal 'down'

\*For Servicing and Maintenance... chassis swings down - trap door fashion - for easy handling and tube replacements.

For complete details, use this coupon



BLONDER-TONGUE LABORATORIES, INC.  
Dept. LM-3, Westfield, New Jersey

Please send complete specs of your new Antenna Booster. I am also interested in:

- TV Amplifiers
- UHF Converters
- Master TV Systems

Name.....

Address.....

City..... Zone..... State.....

# ENGINEERS SCIENTISTS

Junior to Senior Levels  
with some experience in:

## SEMICONDUCTOR DEVICES CIRCUIT DESIGN RADAR

You are needed, well-appreciated, and well-rewarded . . .

## In GOOD PAY In INTERESTING WORK In LONG-TERM PROGRAMS

that will increase your  
career potential at . . .

**Radio Receptor Co.,**  
240 Wythe Ave., Bklyn, N.Y.

● Send resume to: S. Winston ●



Need a Tube Tester?  
**FOLLOW THE  
LEADER . . .**

Buy **EICO**®

TUBE TESTER #625  
KIT \$34.95 Wired \$49.95



• Tests latest  
600-mil  
series string  
type tubes.

More Servicemen buy EICO TUBE TESTERS — in KIT and wired form — than any others sold through distributors. Why? Because EICO gives you the MOST value at LOW-EST cost.

- Test all conventional & TV tubes and pilot lights.
- 10 individual lever-type element switches.
- Illuminated anti-backlash rollchart kept up-to-date by EICO's Engineering Dept.
- 4½" meter, 3-color "Good-Bad" scale.
- Line-adjust control. Blank socket for new tubes. Protective overload bulb.

In stock at your local jobber. Write for free Catalog CT-12 Prices 5% higher on West Coast.

**ELECTRONIC INSTRUMENT CO., INC.**  
84 Withers Street • Brooklyn 11, N. Y.

# Question Box

## CONTROL CIRCUIT

Please publish a circuit of a simple and reliable carrier-current remote control circuit for starting and stopping a distant motor over existing power lines. — D. W. P., Hialeah, Fla.

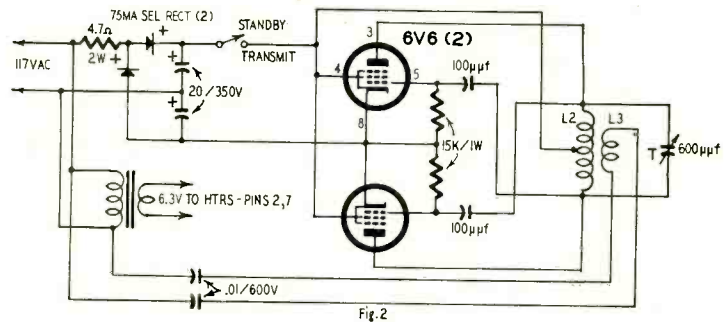
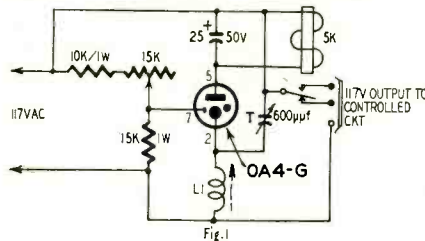

The circuit of the receiver is shown in Fig. 1. The 600- $\mu$ f mica trimmer tunes L1 to the r.f. control carrier. The incoming control signal fires the 0A4-G tube and actuates the relay to open or close the circuit to the remote motor — depending on the connections to the relay contacts. L1 may be the secondary of a slug-tuned broadcast antenna coil connected to pin 2 of the 0A4-G.

The transmitter circuit is in Fig. 2. The oscillator uses 6V6's in push-pull. The 600- $\mu$ f trimmer tunes tank coil L2. The transmitter is operated by closing the switch in the B plus circuit. L2 consists of about 150 turns of No. 28 enameled wire closewound and

center-tapped on a 1½-inch form. L3 is 8 to 10 turns of plastic-insulated hookup wire around the center of coil L2.

The receiver and transmitter must be tuned to the same frequency. The tuning range extends from the high-frequency end of the broadcast band down to around 400 kc. Do not operate on a frequency that causes interference in the r.f. or i.f. circuits of nearby receivers.

Several remote devices can be controlled individually by using separate receivers tuned to different frequencies

and by suitable switching padders across L2.

With the relay circuit shown in the receiver, the transmitter must remain on to maintain the desired operation at the remote point. Therefore, if you do not want to operate the transmitter continuously or if you plan to operate several devices, you can use pulse type control. One pulse turns the equipment on and the next one turns it off. In this case, power to the remote equipment is applied through the contacts of an impulse relay such as the Guardian RC-100. The coil of this relay is then wired through the normally open contacts on the 5,000-ohm control relay in the receiver.

## BATTERY ELIMINATOR

I would like to have the circuit of an a.c.-operated battery eliminator for a fence charger using five No. 6 dry cells in series. — A. C. S., Branford, Ont.

The current drawn by the charger is not given but we are assuming that it does not exceed 600 ma or so. If you find that it is higher, the transformer and rectifier current ratings should be altered accordingly.

With 10 volts a.c. input to the single-phase bridge rectifier, the output will

be about 7.5 volts when the unit is new. Capacitor C may be a 12-volt unit with a capacitance of around 500  $\mu$ f. The output voltage will drop and stabilize at a slightly lower voltage as the

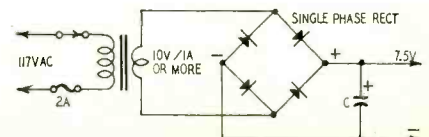

# BROOKS WORLD CHAMPS

In TV Values... Nobody but Nobody else offers... A No. 630 SUPER DELUXE TV KIT for \$99.99, A \$33.50 TV CONVERSION KIT for \$13.97, A \$35.00 TV POWER TRANSFORMER for \$9.16, A \$11.50 AGC KIT including tube for \$2.99, A \$24.50 Super Het Radio including tubes for \$6.99, 20¢ condenser for 2¢, etc.

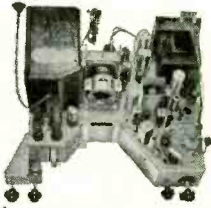

Build your own  
**SUPER DE LUXE  
31-TUBE  
#630 TV CHASSIS**

**#630 SUPER DELUXE 31-TUBE TV KIT**  
OPERATES 16" to 21" PICTURE TUBES • Engineered in strict adherence to the genuine RCA #630 plus added features • FULL 4MC BANDWIDTH • CASCODE TUNER • COSINE DEFLECTION YOKE • LARGER POWER TRANSFORMER • KEYED AGC • 12" SPEAKER • CONDENSERS and RESISTORS at rated capacities and tolerances. You receive a COMPLETE SET of PARTS and TUBES, everything needed is included (less CRT & wire). All I.F. Coils and Transformers are factory pre-aligned and tuned. You will enjoy building it with "LIFE-SIZE" easy to follow step-by-step ASSEMBLING INSTRUCTIONS included with each KIT.

Slashed to **\$99.99** Less CRT

Similar KIT for 24" or 27" CRT \$110.39 slashed to **\$110.39**

## #630 SUPER DE LUXE TV CHASSIS

LICENSED UNDER RCA PATENTS  
COMPLETE READY TO PLUG IN AND PLAY  
Similar in features to the 16" to 21" TV KIT above.

Slashed to **\$142.27** (less CRT)

## #630 B Y TECHMASTER

COMPLETE LINE AT SPECIAL PRICES  
Catalog mailed on request

## Modernize a #630 or any TV Set with a STANDARD CASCODE TUNER

For better all around performance Complete with tubes and Brooks CASCODE MANUAL with step-by-step instructions and all extra parts needed. **\$15.97**

## PULSE KEYED AGC KIT

Finest, most accurate and the easiest Kit to install in any make TV RECEIVER including the No. 630. Improves performance and insures a steady picture on all channels. COMPLETE SET OF PARTS **\$2.99** Including 6AU6 tube & Instructions

## FLYBACK TRANSFORMER

This is the most terrific new sensation in Flyback Transformers. It is similar to the popular No. X-935 and goes up as high as 16kV. With it you receive easy-to-follow instructions and schematic diagrams that apply to improve practically all makes of TV Receivers. **\$4.86**

## BELIEVE IT OR NOT!

AM SUPER RADIO FOR #630 or other TV. Complete, ready to install w/tubes & instructions.



List Price **\$24.95**

Your price slashed to **\$6.99**

## CUSTOM-BUILT CABINETS FOR FACTORY TO YOU

3 LEADING 1956 STYLES in genuine Mahogany or walnut (blond 100% extra Ready drilled for any #630 TV chassis and cutout for any 16", 17", 19", 20" or 21" picture tube at no extras in price • Also supplied with undrilled knob panel for any other TV set • EVERYTHING NECESSARY for an easy perfect chassis and CRT assembly is included • Each cabinet is delivered complete as pictured with mask, safety glass, mounting brackets, backboard, backcup, hardware and assembling instructions • Each cabinet is shipped in an air cushioned carton from FACTORY TO YOU!

WESTCHESTER **\$88.70**

MANHATTAN **\$53.43**

GEM

**\$35.91**



GEM also available for 24" or 27" picture tube **\$59.54**

MANHATTAN also available for 24" or 27" picture tube

**\$79.22**

## DUMONT OR THOMAS PICTURE TUBES

BRAND NEW in Factory Sealed Cartons — With a Full Year Guarantee

17" #17BP4A **\$22.66** | 21" #21EP4B Aluminized **\$32.21** | 24" 90° #24EP4A Aluminized **\$48.99** | 27" 90° #27EP4A Aluminized **\$74.31**

## 21" TV CONVERSION KIT

Positively the HOTTEST item in CONVERSIONS. Customers tell us they even use it to bring a 21 Set up-to-date for greater power, brilliancy and clarity.

Convert ANY MAKE TV RECEIVER including #630 to operate the 21" or ANY 70° PICTURE TUBE

COMPLETE SET OF ESSENTIAL PARTS includes matched set of Todd 70° COSINE DEFLECTION YOKE and TODD HV FLYBACK TRANSFORMER

List Price **\$33.50**

Your price... **\$13.97** Incl. CONVERSION MANUAL with Step-by-Step Instructions & Diagrams.

Similar Kit for 24", 27" or any 90° picture tube **\$15.98**

## PM SPEAKERS (ALNICO #5)

Brand New Factory Guaranteed Stock 1 oz. mag. on 3" to 6", heavier mag. on 8" & 12"

3" ..... \$ .98 | 6" ..... 1.58  
4" ..... 1.17 | 8" ..... 2.64  
5" ..... 1.29 | 12" ..... 4.67

## #630 Parts in COMPLETE SETS

TV WIRE & SOLDER KIT, for any Set.....\$ .98  
630-KIT, screws, nuts, rivets, washers, etc..... 1.69  
VIDEO AND I.F. KIT, 19 items..... 4.99  
VARIABLE CONTROL KIT, 9 controls..... 3.97  
CARBON RESISTOR KIT, 107 resistors..... 4.98  
WIREWOUND RESISTOR KIT, 4 resistors..... 1.76  
ELECTROLYTIC CONDENSER KIT, 6 cond..... 4.96  
TUBULAR CONDENSER KIT, 38 condensers... 3.63  
CERAMIC CONDENSER KIT, 28 condensers... 1.98  
MICA CONDENSER KIT, 11 condensers..... .97  
COMPLETE SET OF TUBES, 29 tubes..... 24.64  
POWER TRANSFORMER, 295 ma. 201T6..... 9.16

## FREE WITH THESE PACKAGE DEALS

CONDENSER & RESISTOR CODE CHARTS... with all orders  
New 10-SIZE HEX. WRENCH with every \$5 order  
STEEL CABINET, 12 x 8", 16 lucite see-thru Drawers, 48 Sections... with every \$25 order.

Every Assortment contains the most desirable types and sizes to enable you to get most repairs done with the least investment. All items are STANDARD, BRAND NEW and AMERICAN MADE.

**100 ASSORTED TUBULAR CONDENSERS**  
All Are Standard Brands & Desirable Sizes **\$3.69**  
\$15.00 Value Only

**100 ASSORTED 1/2 WATT RESISTORS \$2.88**

**15 Asst. Radio Electrolytic CONDENSERS \$3.49**

**15 Assorted TV Electrolytic CONDENSERS \$4.97**

**100 ASSORTED MICA CONDENSERS \$3.72**

**100 ASSORTED CERAMIC CONDENSERS \$3.72**

**100 ASSORTED 1 WATT RESISTORS \$4.62**

**100 ASSORTED SOCKETS \$2.79**  
Octal, Loctal & Miniature

**100 ASSORTED KNOBS \$2.84**  
SCREW & PUSH-ON

**10 VOLUME CONTROLS \$2.63**  
ASSORTED, WITH SWITCH  
1/4, 1/2, 1, 2 meg. and others

TUBULAR CONDENSER .02-400v..... 2¢  
TUBULAR CONDENSER .047-400v..... 5¢

Brooks LIFE-SIZE TV INSTRUCTIONS for building any #630 TV Receiver from the original 10" to the latest 27" **\$1.25** postpaid

90° TV CONVERSION MANUAL, how to convert any TV SET to 24", 27", etc. **50¢** postpaid

HINTS FOR BETTER PERFORMANCE on your #630 TV receiver **50¢** postpaid

70° TV CONVERSION MANUAL, how to convert any TV SET to 17", 21", etc. **50¢** postpaid

Brooks CASCODE MANUAL, how to install Cascode Tuner in any make TV Set **25¢** postpaid

A.G.C. STEP-BY-STEP INSTRUCTIONS, how to add A.G.C. to any make TV Receiver **25¢** postpaid

**BROOKS RADIO & TV CORP., 84 Vesey St., Dept. A, New York 7, N.Y.** TELEPHONE Cortland 7-2359

**PRICED AMAZINGLY LOW  
FOR BIGGER MARK-UP  
... FASTER TURNOVER**

## Sky-Ray ANTENNAS

offer you more profits! How? By giving quality equal to or better than other TV antennas *plus* amazingly low prices that provide bigger mark-up or faster turnover. This combination of quality and price is achieved by excellent engineering coupled with cost-conscious construction. Standard weight materials are used throughout and none are wasted. Clean, functional design contributes a pleasing appearance but eliminates expensive "gingerbread". The results are all-aluminum antennas . . . lightweight and rugged . . . that sell fast. And all Sky-Ray Antennas are pre-assembled.

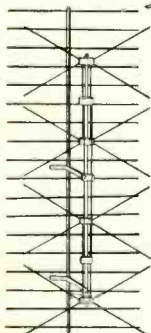
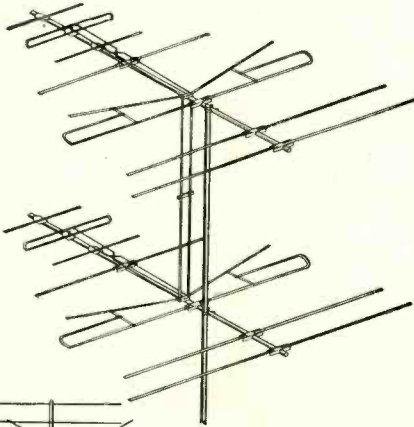

Model ACV-2 "SUPER-RAY". All-Channel VHF Antenna . . . Sky-Ray's new twin-bay model featuring improved front-to-back ratio and higher gain. Has Snap-In construction, reinforced at the U-bolt connection. Matches 300-ohm transmission line. Suggested list price . . . \$24.50.

Model UCP All-Channel UHF Array. Highest gain and front-to-back ratio on UHF. Completely pre-assembled; only 4 wing nuts to tighten. Suggested list price . . . \$10.85.

**SNAP-IN CONSTRUCTION.** One push and elements are locked securely in position. No bolts to tighten. This feature on all Sky-Ray VHF Antennas gives the easiest, fastest installation possible.

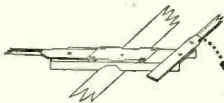

Sky-Ray offers complete lines of proven, top-quality, low-priced antennas for all TV bands: for VHF . . . Snap-In Yagis, Conicals, and In-Lines; for UHF . . . Bow Ties, and Single and Double Corner Reflector types. Get these big-profit antennas now. Ask your jobber for specifications and price lists or write direct to . . .

**SKY-RAY MANUFACTURING CO.**

McLEANSBORO, ILLINOIS

### QUESTION BOX

rectifier ages. You can bring it back to the original value by increasing the capacitance of C. The rectifier may be a selenium or copper-oxide type. Its input voltage rating should be at least 15 volts r.m.s.

This circuit may be used for battery chargers and as a d.c. supply for electroplating. For currents up to around 10 amperes you can use a transmitting type filament transformer. For higher currents, use two or more such transformers with the windings in parallel. A Variac, Varitran or similar variable autotransformer can be used on the input side of the supply to vary the output voltage. However, take care that the a.c. applied to the rectifier does not exceed the manufacturer's ratings.

### VERSATILE POWER PACK

Please print a diagram of a power supply that will deliver 200 volts d.c. at 25 ma and 6.3 volts a.c. at 1 ampere for a Granco HT-5 converter and other small equipment such as phono pre-amplifiers and mixer units.—W. J. F., East Springfield, Mass.

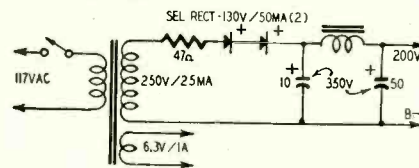

This circuit should meet your needs. The transformer is a Stancor PS-8416 or equivalent. Two 130-volt selenium rectifiers are connected in series to handle the a.c. input voltage. If the d.c. output voltage is too high, insert a suitable dropping resistor in series with the filter choke, an a.c.-d.c. type.

### 120-WATT BOOSTER AMPLIFIER

Please print a diagram and other pertinent data on a 120-watt booster amplifier using a pair of 807's or similar tubes. This amplifier is to be driven by a 25-watt amplifier with a 500-ohm output.—M. C. E., Maryland Heights, Mo.

The diagram shows the circuit of a 120-watt amplifier using zero-bias 807's in class B. Note well that the tubes

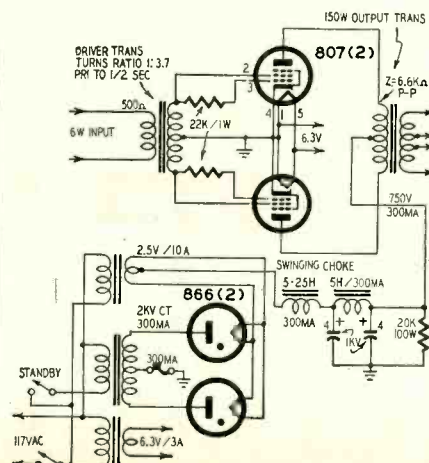

(Continued)

operate as triodes with the signal voltage applied *directly* to the screen grids and to the control grids through 22,000-ohm resistors. The driver transformer should be rated at 8 watts or more and designed for matching a 500-ohm line to class-B grids. The turns ratio of primary to one-half secondary should be approximately 1:3.7.

The power supply is designed for good regulation. Do not skimp on the quality of the power transformer and filter chokes. Always make sure that the 807's and 866's have warmed up before closing the standby switch to supply B power.

The power transformer secondary delivers 1,000 volts plate to ground to each 866. The rectifiers work into a choke input filter containing a 5-25-henry swinging choke and a 5-henry unit, both rated at 300. Both filter capacitors are 4- $\mu$ f units rated at 1 kv. The power transformer secondary center tap is fused.

### VARIABLE CAPACITORS

I plan to build the novice transmitter described in the September, 1953, issue but I've not been able to find the 325- $\mu$ f 1,000-volt variable capacitors nor the 135-volt 75-ma power transformer. Please recommend these components by brand and type number. In some instances transmitting type capacitors are rated according to the spacing between plates rather than the test or breakdown voltage. Please show the relationship between spacing and voltage.—A. F. B., Wenham, Mass.

The exact relationship between plate spacing and breakdown voltage depends on the construction of the capacitor and on the frequency and other standard conditions that the manufacturer uses for the test. Generally, capacitors having mirror-smooth plates with rounded edges have higher voltage ratings than those with the same spacing and unpolished plates with square edges.

Catalogs issued by the leading capacitor manufacturers show that some list the test voltage at 60 cycles r.m.s. and others list the maximum peak voltage. Oddly enough, the r.m.s. and peak voltages are often very nearly identical for the same air gap. The voltage vs. spacings are fairly close among various manufacturers for voltages up to 3 kv and then they begin to spread rapidly. Thus, when purchasing capacitors for higher-powered transmitters, it is always advisable to consult each manufacturer's catalog for his ratings.

A capacitor with plate spacing of .024-.025 inch will handle peak voltages of 1,000-1,200; .034-.047 inch will handle 1,600 volts; .051-.065, 2,000 volts; .07-.078 inch, 3,000-3,600 volts. For the novice transmitter you can use Hammarlund MC-325-M, National STH-335 or Bud TMS-300 capacitors in the pi network.

The transformer may be a Thordarson T-22R12. It is rated at 125 instead of 135 volts but the difference will not affect transmitter performance. END



# Technotes



## TV INTERFERENCE

In weak-signal areas or locations where an indoor antenna is used, cross-hatch interference in an Admiral 20Z1 is sometimes caused by slight regeneration in the 6AU6 4.5-mc sound i.f. stage (see diagram) without affecting the sound in any way. If this is the

case, removing the 6AU6 should eliminate the interference. To correct the situation, substitute a 10,000-ohm resistor for the 1,000-ohm unit in the plate circuit of the sound i.f. stage. Similar cases were found in servicing G-E and RCA sets.—*G. P. Oberto*

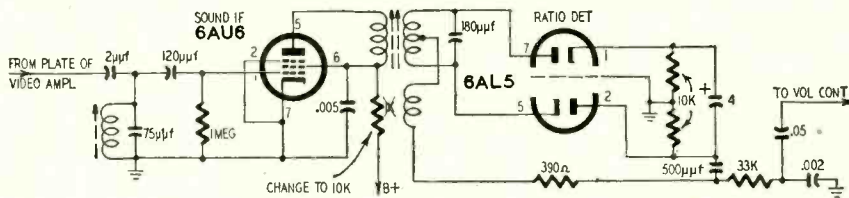

## RASTER TEARING AND FLASHING

In an RCA TV model 6T7I the source of picture and raster flashing and tearing, similar to high-voltage arcing, couldn't be located. In attempting to localize the source I found that removing the 1B3-GT high-voltage rectifier

did not affect the noise but, if either the horizontal oscillator, horizontal output or 6W4-GT damper were removed, the noise stopped. Yet substituting these tubes did not help. I inspected the high-voltage and 6W4 boost-voltage

circuits in a darkened room but failed to see any arc. After hours of checking and substituting components in these circuits I localized the trouble in

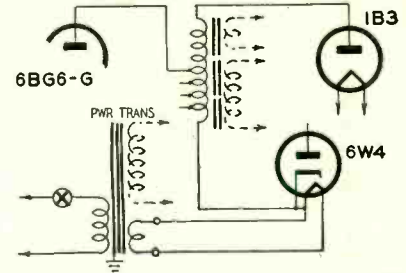

the 6W4 boost-voltage circuit. The trouble was finally found in the power transformer.

This is what had happened. The 6W4 damper tube had its own separate heater winding above ground (see diagram), allowing the heater and cathode to be tied together to eliminate heater-cathode arc-over. This arrangement places 500 volts, plus surge voltages, on the 6W4 heater and its winding. I removed the cover of the transformer and found that the 6.3-volt 6W4 heater winding had been arcing to the transformer cover; the polyethylene insulation on the inside of the cover had broken down.

By cutting down the heater winding terminals, removing all sharp points and replacing the damaged insulation with a heavier grade, the trouble was eliminated. That was more than two years ago, and it has never recurred.—*Charles Garrett*

Get This Valuable Book

Just for Examining COYNE'S New 6-Volume Set

# FREE



# "Applied Practical Radio-Television"

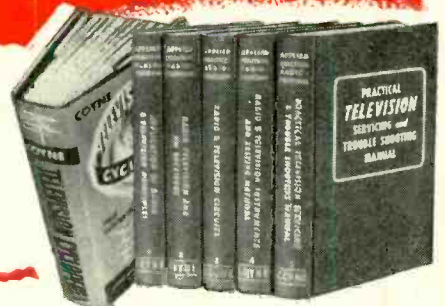

ON 7 DAY  
FREE  
TRIAL!

Yes, you get this big, brand new book, "150 Radio-Television Picture Patterns and Diagrams Explained", absolutely FREE! Just off the press! Gives complete 11x22" Schematic Diagrams on leading models Radio and Television Sets. Easy-to-read, large 8½x11" pages, with full instructions on how to read and use the diagrams. A "must" in every Radio and Television service-man's repair kit. You get this valuable book as a FREE Gift for asking to see Coyne's great new 6-book set, "Applied Practical Radio-Television"!

**'At Last! Money-Making "Know-How" on Transistors, Color TV and Servicing**

Coyne's great new 6-volume set gives you all the answers to servicing problems—quickly! For basic "know-how" that is easy to understand, you'll find everything you want in volumes 1 to 5 which contain over 5000 practical facts and data. They cover every step from principles to installing, servicing, trouble-shooting and aligning all types of radio and TV sets. So up-to-date it includes COLOR TV and UHF, adapters, converters. Also covers latest data on TRANSISTORS.

**Extra! 900-Page Television Cyclopeda Included**

And then, for speedy on-the-job use, you get volume 6—the famous Coyne TELEVISION CYCLOPEDIA. It answers today's television problems on servicing, alignment, installation and others. In easy-to-find ABC order, cross indexed. Use this 6 volume TV-RADIO LIBRARY free for 7 days; get the valuable Servicing Book ABSOLUTELY FREE!

Educational Book Publishing Division

**COYNE ELECTRICAL SCHOOL**  
500 S. Paulina St., Dept. C5-T1, Chicago 12, Ill.

**SEND NO MONEY!** Just mail coupon for 6-volume set on 7 days free trial. We'll include book of 150 TV-Radio Patterns & Diagrams. If you keep the set, pay \$2 in 7 days and \$2 per month until \$22.50 plus postage is paid. (Cash price \$20.95). Or you can return the library at our expense in 7 days and owe nothing. **YOU BE THE JUDGE. Either way, the book of TV-Radio Patterns is yours FREE to keep!** Offer is limited. Act NOW!

**FREE BOOK—FREE TRIAL COUPON!**

Educational Book Publishing Division  
**COYNE ELECTRICAL SCHOOL, Dept. C5-T1**  
500 S. Paulina St., Chicago 12, Ill.

YES! Send 6-volume "Applied Practical Radio-Television" for 7 days FREE TRIAL per your offer. Include TV-Radio Patterns & Diagram Book FREE.

Name ..... Age .....

Address .....

City ..... Zone ..... State .....

Where Employed .....

( ) Check here if you want library sent COD. You pay postman \$20.95 plus COD postage on delivery. 7-day money-back guarantee.

# Use Your Military Training

*The time was never more opportune than now for becoming associated with the field of advanced electronics. Because of military emphasis this is the most rapidly growing and promising sphere of endeavor for the young electrical engineer or physicist.*

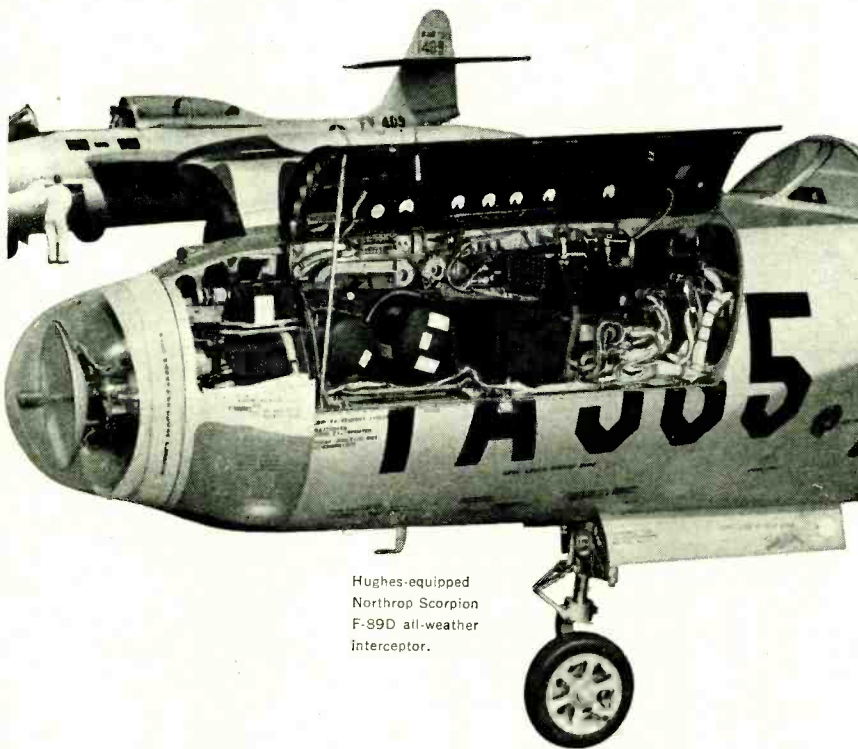

Hughes-equipped Northrop Scorpion F-99D all-weather interceptor.

Scientific Staff  
Relations

## Hughes

RESEARCH AND  
DEVELOPMENT  
LABORATORIES

Culver City  
Los Angeles County  
California

**E.E. or PHYSICS GRADUATES**  
*with experience in*  
**RADAR or ELECTRONICS**  
*or those desiring to enter these areas...*

Since 1948 Hughes Research and Development Laboratories have been engaged in an expanding program for design, development and manufacture of highly complex radar fire control systems for fighter and interceptor aircraft. This requires Hughes technical advisors in the field to serve companies and military agencies employing the equipment.

As one of these field engineers you will become familiar with the entire systems involved, including the most advanced electronic computers. With this advantage you will be ideally situated to broaden your experience and learning more quickly for future application to advanced electronics activity in either the military or the commercial field.

Positions are available in the continental United States for married and single men under 35 years of age. Overseas assignments are open to single men only.

## TECHNOTES

(Continued)

### HORIZONTAL PIX WIGGLE

Annoying, although small, wiggle or horizontal shaking of random spots in the picture was a complaint on a G-E 17C107. The trouble happened only on rainy days, and not on other occasions even during or after a short thunder shower. The fact that the displacement, when it did occur, was horizontal provided some useful information—the search could be limited to the horizontal deflection circuitry rather than the entire set.

In the shop, a wet rag was placed under the set and the set turned on. The rag was so shaped and placed that it would produce very high humidity around one quarter of the chassis area. After a couple hours, the rag was soaked again and placed under another quarter of the chassis area. All four quarters of the bottom of the chassis were covered in this manner, but the trouble did not occur. The conclusion was that the underside of the chassis was not causing the trouble.

The wet rag was placed near parts on the top side of the chassis and the entire chassis, except that the picture-tube face was covered with a cardboard carton to hold the moisture in. Trouble developed in about an hour.

Movement of the rag indicated the trouble spot near the underside of the picture tube. The rag was then reduced in size and balled up so that it could be attached to the end of a stick of wood with rubber bands. The trouble was localized to the underside of the middle of the bell of the picture tube. The only thing observable was the filter



Capacitor is touching Aquadag coating.

capacitor shown in the photograph. The capacitor was touching the Aquadag coating of the picture tube, but was insulated with a fiber covering—there seemed to be nothing wrong with this arrangement. A pipe cleaner was moistened with water and touched to the capacitor casing and the Aquadag at their point of contact. The trouble appeared immediately. Moving the capacitor away from the picture tube removed the trouble.

The explanation of the action is interesting. The Aquadag is grounded through springs, but due to high voltages with their accompanying fields, the coating is not fully at ground potential. The additional grounding altered the normal distribution of ground current and in so doing upset the electron beam.

The current flow along the bottom

of the tube set up a magnetic field in a vertical direction. A vertical magnetic field will deflect a charged particle—like the electrons in the beam current—at right angles to its direction, causing a horizontal shift. Variation in the conductivity accounted for the randomness of the time of appearance and the amount of picture area involved.

It was noted that the trouble appeared only during a prolonged rain. The owner's 6-month-old daughter's diapers were dried by the gentle heat of the TV set on a rack at its back. During fair weather daughter's pants were hung on a line and on days with thunder showers, the need was not so urgent. So with the capacitor moved away from the picture tube coating, the set still functions both as a source of amusement and a diaper drier on wet days.—James A. McRoberts

**IMPLODED TV TUBE**

The photo of the imploded TV set on page 46 of the February issue recalls a similar occurrence in a Zenith model M2230R. The customer heard a frying sound and turned the set off. A few moments later there was a loud blast. A part of the picture-tube neck shattered and the safety glass showed lots of scratches.

I took the set to the shop and I believe that I've located the cause of the trouble. These models have a metal-sleeve width coil that fits over the neck of the picture tube. This sleeve was grounded and shorted to the yoke coil. The short circuit to ground caused excessive current to flow and overheat the tube neck at the point of the break.—R. H. Rahn

**SLOW-BLOW FUSES**

The use of a fuse of the slow-blow type in the high-voltage circuit is not recommended. Slow-blow fuses generally have early life failures due to metal fatigue. Therefore, when it is necessary to replace a fuse, the standard type fuse listed in the replacement parts list should be used.—RCA TV Service Tips

**SENTINEL 406, 411**

Tearing and picture breakup when these models are jarred are often caused by a loose padder trimmer slug screw in the 12AT7 oscillator stage. To remedy, install a lockwasher bushing on the padder (C11) trimmer screw to hold it firmly and provide a proper ground.—Ernie Gig

**TELEPHONE 248**

Some of these sets come in with a complaint of picture height decreasing to about 2 to 3 inches. I found that this was caused by the 1.5-megohm resistor in series with the height control. It reduced in value to about 500,000 ohms. Replace this resistor with a good-quality high-wattage unit.—Marty Britt END

# FREE! BA's NEW 1956 CATALOG

**YESSIR-IT'S THE KING-SIZE CATALOG—**  
**164 "KING-SIZED" (8 1/4 x 10 1/2) PAGES**  
**OFFERS MORE ITEMS PER PAGE--IT'S EASIER TO USE...IT'S EASIER FOR YOU TO ORDER**

**COMPLETE GUIDE TO EVERYTHING IN RADIO, TV, ELECTRONICS**

**100'S OF BRAND NEW ITEMS LISTED HERE FOR THE VERY FIRST TIME**

**INCLUDES 21 BIG PAGES OF BARGAINS NOT FOUND IN ANY OTHER CATALOG**

**Guarantee**

*We guarantee everything we sell. Nothing to be at the quality and value represented in our literature. If you are not satisfied, we will refund your money and ship you the merchandise you ordered. No questions asked.*

**BURSTEIN-APPLEBEE CO.**  
 KANSAS CITY 6, MISSOURI

**RUSH COUPON FOR THIS BIG CATALOG NOW!**

Send Free B-A Catalog No. 561.

NAME \_\_\_\_\_

ADDRESS \_\_\_\_\_

CITY \_\_\_\_\_ STATE \_\_\_\_\_

Watch for the **JANUARY SPECIAL TV ISSUE** of **RADIO-ELECTRONICS**

**LMB BOX CHASSIS**

Flangelocking Precision Interlocking Engineered

65 sizes and shapes for the laboratory, manufacturer, industrial, experimenter, builder, and general applications where metal boxes are required. Stocked by all electronic and geophysical distributors. Send for free catalog.

**LMB** 1011 Venice Blvd. Los Angeles 15, Calif.

## don't stand on your head!

let the **MASTER** show you the easy way... see pg. 155

# Hi-Fi and Hi-Price aren't Siamese Twins!

The new imported *Fer-tone*<sup>Hi-Fi</sup> is out to prove this to you. Now you can get professional features you always wanted—at prices you will gladly pay.

## *Fer-tone* "BRENNEL" HI-FI TAPE DECK

### A FOOLPROOF 3-SPEED UNIT FOR LIFETIME USE

- Three speeds: 3 3/4 ips      7 1/2 ips      15 ips
- Frequency Response: 50-6500      50-12000      30-15000
- Playing Time: 2 hours      1 hour      1/2 hour
- Three independent AC motors • Dual tracks—7" reels • Positive interlock of all switching and braking mechanisms, including automatic pinch-roller and pressure pad assembly • Instantaneous mechanical braking • Simple two-knob operation: The left for "Fast Forward" and "Rewind" (within 45 seconds); the right for "Record/Playback" and "Off" • WOW and FLUTTER less than .2% • High fidelity heads have mumetal shields for hum-free operation. Hi-Z Record/Playback head with adjustable azimuth, ideal for all makes of pre-recorded tapes • Heavy Duraluminum base plate 15" x 11 1/2" • Highest quality precision workmanship.

Audiophile Net: \$79.50

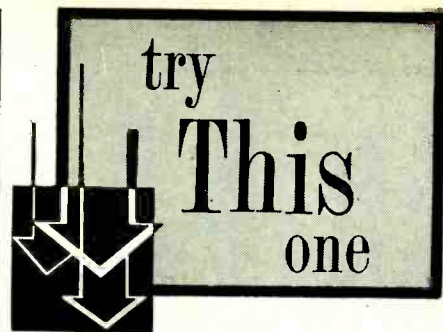
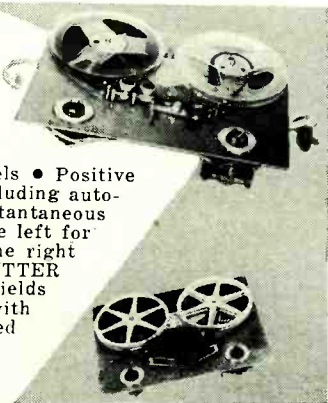

### TESTING OF RECORDING TAPES

Magnetic recording tape comes in a wide variety of brands and price ranges, making it difficult to tell which brands of tape are worth using. But here is a comparative test which very simply demonstrates the relative output available from any two tapes.

Take sample lengths (3 to 5 feet) of any two tapes, give them identifying marks, and splice them together. Run this spliced sample through the recorder while applying a steady signal to the input. Then splice the free ends of this composite tape together to make one continuous loop. Insert this in the tape machine and play back.

When measured with a v.t.v.m. or oscilloscope, the relative outputs of the two tapes can be compared easily.

Even without a signal generator or measuring instruments, significant results can be obtained by whistling a steady note into the tape recorder microphone and listening to the playback. With just a little practice one can whistle a note that will be steady enough for the purpose. A good variation of this test is to use the voice or a musical passage as the signal. A general listening test can then be made.

If available, a sawtooth signal generator and oscilloscope are excellent instruments when making tests on a tape recorder. Not only can the relative outputs of different tapes be measured but also their frequency response and that of the tape recorder. This is so because any reproducing system that passes perfectly a sawtooth wave of a certain frequency will also be flat for a band of sine waves in the range of about 1/10 to 10 times the sawtooth-wave frequency. (See "Check Audio Response with a Neon Glow Tube," RADIO-ELECTRONICS, November, 1952, and "Testing with White Sound," *Audio*, October, 1954.) A tape system that reproduces a 600-cycle sawtooth without distortion will be flat from about 60 to 6,000 cycles.—*Charles Wolf*

### SHORTWAVE CONVERSION

Many small broadcast receivers can be easily converted to receive the 1.5-5.5-mc band by simply switching high-Q parallel inductors L2 and L3 across the antenna and oscillator coils as shown in Fig. 1. Converted sets compare favorably with many of the small amateur communication receivers on the 75-meter band.



THE NEW *Fer-tone* <sup>De</sup> B&O-350 Lo-Z PROFESSIONAL MAGNETIC CARTRIDGE. Works on any load over 1000 ohms. 30 mV/4.4 cm/sec. output, due to 8-poles. Highest 5x10<sup>-6</sup> cm/dyne lateral compliance. Response 20-16,000 cps flat ± 2 db then gradually rising to over 20,000 cps.

Audiophile Net:

B&O Reversible, Silver Label (2 sapphire jewels).....\$7.95  
B&O Reversible, Gold Label (1 diamond, 1 sapphire).....\$19.95

THE NEW MINIATURE *Fer-tone* <sup>De</sup> B&O-50 BLUE RIBBON STUDIO TYPE VELOCITY MIKE. Its exceptional great sensitivity, low (1.3 mg) mass and novel three-way "Close Talk", "Music" and "Off" switch make it the ideal tool for the sound engineer. Impedance 50 ohms. Frequency Range: 30-15,000 cps ± 2 db. Sensitivity: "T" position -59 db; "M" position -55 db. Size: 7 3/4" x 1-3/16". Weight: under 15 oz. Shipped with 20' shielded 3-conductor cable.

Audiophile Net: \$48.95

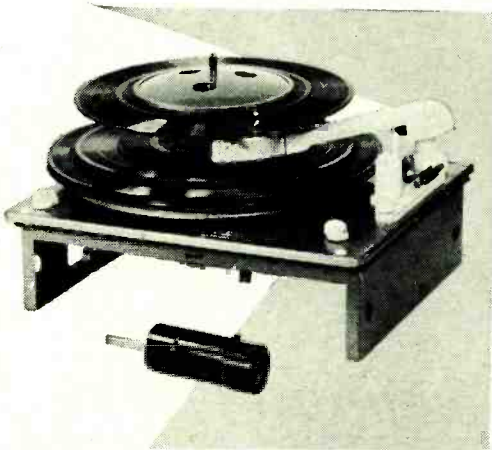

**REX**  
Perpetuum-Ebner

### THE MOST PERFECT CHANGER EVER BUILT—SERVES ALSO AS TURNTABLE

PE REX is the changer used in deluxe models by Blaupunkt, Grundig, Telefunken, etc.—by over 85% of continental Hi-Fi manufacturers.

PE REX is the changer C. G. McProud compared to professional turntables. (*Audio*, May 1955)

A truly mechanical brain, it intermixes records from 6" to 12". World's best shaded 4-pole phono motor with double chassis, factory-tuned spring suspension. No audible rumble or acoustic feedback. Automatic shut-off. Short spindle for manual play.

Audiophile Net: \$59.50

45 rpm Automatic Spindle (Add.) Net \$3.50

Literature on request. Sold through better audio distributors

FENTON COMPANY

15 MOORE STREET

NEW YORK 4, N.Y.

## RADIO-ELECTRONICS 9th ANNUAL TV ISSUE January 1956

Once again, it will offer you the most complete and up-to-the-minute TV information of any issue of any magazine. Make sure you get your copy. Subscribe now and we will reserve a copy of the big 50¢ issue for you at no extra cost.

ON SALE DECEMBER 29, 1955

RADIO-ELECTRONICS

25 West Broadway

### A Few Features

- Most useful schematics of 1955—a complete section.
- Color TV Test Equipment
- Color TV Bar Generators
- TV Receiver Design in 1955
- Plus many, many others on TV, Radio, audio-high fidelity

### Subscription Rates

3 Years \$8.00  
Save \$5.05 over newsstand rates

2 Years \$6.00  
Save \$2.70 over newsstand rates

1 Year \$3.50  
Save 85¢ over newsstand price

New York 7, N.Y.

TRY THIS ONE

(Continued)

On some of the older sets using 6A7, 6A8, 6K8 and similar converter tubes, the oscillator may fail because of lack of coupling in the feedback circuit. To overcome this add an auxiliary feedback coil (L4) as in Fig. 2. If the oscillator fails to work, reverse the connections to L4.

A Vari-Loopstick with 25 turns re-

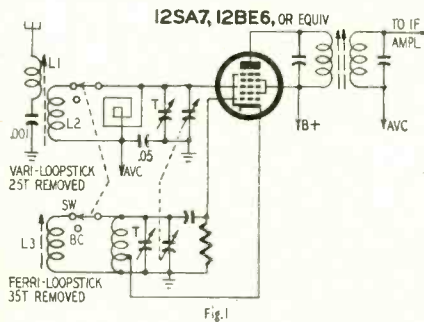

Fig. 1

moved is used for L2. L1 is approximately 100 turns of No. 30 enameled wire jumble-wound close to the ground end of L2. Oscillator shunt coil L3 is made by removing approximately 35 turns from a Ferri-Loopstick and adding 15 turns of No. 30 wire for L4.

Circuits are aligned by varying the number of turns for desired coverage

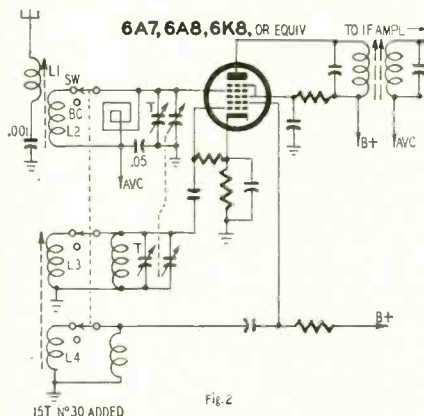

Fig. 2

and to peak the signal with the coil slugs almost all the way in and the tuning capacitor about half open.

For frequencies above 5.5 mc, remove all the turns from the loopstick and close-wind about 25 turns of No. 30 wire. Add or remove turns for the desired coverage with the slug almost all the way in. Adjust the slug and turns of L2 to peak the signal in the center of the band.

For higher-frequency coverage up to 15-20 mc it would be more desirable to use the conventional method of bandswitching. However, the circuit of Fig. 2 should work nicely up to 15 mc by using oscillator harmonics. The circuit of Fig. 1 should hit the 40-meter band without any trouble simply by removing more turns from the shunt coils. The oscillator could be tuned so the desired harmonic is equal to the signal frequency plus or minus the i.f., and the antenna coil could be peaked at the signal frequency. However, the main drawback is that strong low-frequency signals may ride through.

The 100-turn antenna coil L1 works

**INDEPENDENT SCIENTIFIC SURVEY  
AND LAB TESTS PROVE  
PRECISE MODEL #111---"BEST  
COMMERCIAL TUBE TESTER  
AT ANY PRICE"...**

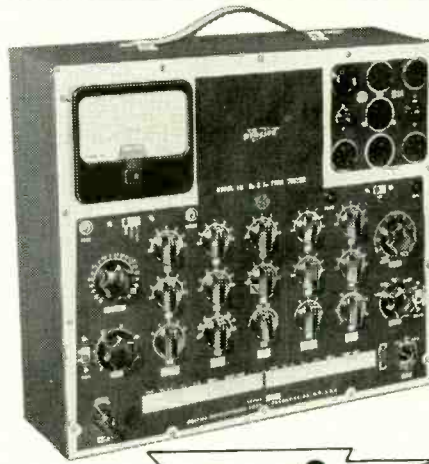

Now You Can Check Tubes  
The Manufacturer's Way

- Checks both emission and mutual conductance
- Checks all tubes including hearing aid, miniatures
- Six different plate voltages
- Different grid signals
- Simplified Short check
- Gas check
- New type switches
- Deeply etched aluminum panel
- Three different screen voltages
- Latest roll chart
- Measures filament current
- Measures grid bias

**precise**  
Model #111

111K (kit form) **NOW ONLY \$69<sup>95</sup>**  
111W (factory wired) ..... \$139.95

**Mutual Conductance and Emission TUBE TESTER**

An independent scientific survey conducted by an impartial testing laboratory confirms what purchasers already know: "The most advanced, the most complete tube tester and the best priced is made by PRECISE DEVELOPMENT CORP., Oceanside, N. Y."

**CHECK THESE ADDITIONAL 'specs' ... TALK TO YOUR JOBBER  
AND TO ANYONE WHO HAS THIS OUTSTANDING TUBE TESTER ...**

The Model 111 is the only single commercial tube tester that checks all tubes for both EMISSION and MUTUAL CONDUCTANCE separately. Filament current is measured directly on large meter when checking a VOLTAGE SAPPER tube. NEW, MODERN DESIGNED ROTARY SWITCHES allow you to check each tube element individually. NEW TYPE Single Rotary switch for complete short checks. The 111 makes all BIAS,

FILAMENT VOLTAGE, GAS, LIFE checks visually on large meter ... 5 individually calibrated ranges and scales for mutual conductance tests. NEWLY DESIGNED "NO BACKLASH" ROLL CHART lists all tubes including the new type 600 mil series tubes. Provisions are made for testing many color tubes. All CRT's can be checked with accessory adaptor, Model PTA.

For Information on where to purchase this and other Precise "Bests", see your local jobber or write —

**precise DEVELOPMENT CORP., OCEANSIDE, NEW YORK**

**50 WATTS from your WILLIAMSON**

*New DYNACO A-430*



**\$29.95**

at your Electronic  
Parts Distributor  
or Audio Jobber

Output transformer and simple circuit modifications let you raise the power of your Williamson-type amplifier to over 50 watts at less than 1% I M distortion. This super-fidelity output transformer will give you double power and double listening pleasure with very low distortion and unequalled transient bandwidth. Its unique design uses para-coupled windings, the first basic advance in quality transformer design since the introduction of interleaved windings.

Write for details of new Dynaco output transformers, circuits, and conversion data for Williamson Amplifiers.

**DYNA COMPANY, 5142 Master St., Phila. 31, Pa.**



FOR *High Fidelity*  
SOUND REPRODUCTION

A top-grade High Fidelity Amplifier and Remote Control Unit from the world-famous Pye Research Laboratories in Cambridge, England. Smooth, highly flexible controls and facilities for record player, tape recorder, microphone and radio tuner inputs. Frequency response substantially flat from 2 to 160,000 c.p.s. Infinite damping factor. Intermodulation distortion under 1% at output of 25 watts.

PYE LTD., CAMBRIDGE, ENGLAND



A.3

**DISTRIBUTORS** U.S.A. ▶ **BRITISH RADIO ELECTRONICS**  
1883 JEFFERSON PLACE, N.W. WASHINGTON 6 D.C.  
CANADA ▶ **PYE CANADA LTD. AJAX, ONTARIO**

*"I had a terrible night last night—dreamt we were out of JENSEN NEEDLES."*

**GET MORE WORK OUT OF YOUR OSCILLOSCOPE!**

Learn to service ANY radio or TV easier and faster!

Here, in a brand new 2nd edition, is THE book that really shows you how to use oscilloscopes!

Clearly as A-B-C, MODERN OSCILLOSCOPES AND THEIR USES tells you exactly when, where and how. You learn to locate either AM or FM radio or television troubles in a jiffy. Even tough realignment jobs are made easy. No involved mathematics! Every detail is clearly explained—from making connections to adjusting circuit components and setting the oscilloscope controls. And you learn to analyze patterns fast and RIGHT!

**Just Out! NEW 2nd EDITION!**

Includes latest data on use of 'scopes in color TV, industrial electronics, teaching... even in atomic energy work. Over 400 pages and over 400 clear pictures. Dozens of pattern photos make things doubly clear.

**PRACTICE 10 DAYS FREE!**

Dept. RE-125, RINEHART & CO., Inc.  
232 Madison Ave., New York 16, N. Y.

Send new 2nd edition of MODERN OSCILLOSCOPES AND THEIR USES for 10-day examination. If I like book, I will then send \$6.50 (plus postage) in full payment, or return book postpaid and owe you nothing.

Name .....

Address .....

City, Zone, State .....

OUTSIDE U.S.A.—Price \$7.00, cash with order only. Money back if you return book in 10 days.

RINEHART BOOKS ARE SOLD BY LEADING STORES

TRY THIS ONE (Continued)

very well on antennas from 10 to 75 feet. On some sets using loop antennas the loop alone picks up plenty of signals. I was surprised to hear several weak mobiles that were S4 on my 12-tube communications receiver. Of course the selectivity was far better on the large receiver.—G. P. Oberto

**PLASTIC RADIOS**

Many plastic table model radios do not have soft pads on the bottom—either the set rests directly on the furniture or else is supported on sliders. The plastic bottom or sliders are likely to mar fine furniture if the set is pushed roughly. Before placing these sets on expensive furniture, cut felt pads about the size of a dime and glue them to the bottom of the cabinet.—B. W. Welz

**SOCKET REPAIRS**

Broken socket contacts often occur in sets using miniature tubes. In most cases the best remedy is to replace the socket with a new one. However it is often very hard to remove the socket due to crowding of the components. A completely satisfactory repair can be made by replacing only the broken contact.

Since replacement contacts are not available on the market, a new socket of each type commonly used should be obtained. Removing the contacts is simple but use extreme care as they are easily broken or weakened. The technique varies slightly with different types of sockets, but if a careful examination is made the procedure will be obvious. In some sockets the projecting solder lug should be flattened for removal; in others it should be rolled tube like to allow it to pass through the top of the socket. One type of socket requires removal of the metal grounding sleeve in the center guide hole to remove the contacts. When the sleeve is loosened, the fiber washer is removed and the contacts taken out from the bottom of the socket.

Finally place the new contact in the socket and hold it firmly in place while bending the projecting end just enough to keep it in position.—James E. Pugh, Jr. END

*"This time I'm really going to tell the boss off."*

MODEL  
**PRECISION 612**  
RELIABLE TUBE TESTING  
AT MODERATE COST

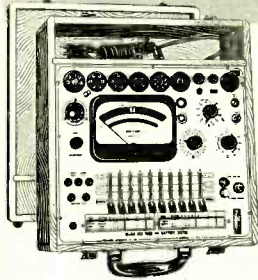

Employs popular RETMA emission type circuit

- ★ Tests All Modern Tube Types - Fil. Voltages 3/4 to 117 volts.
- ★ Built-in 7 & 9 Pin Straighteners.

- ★ Absolute Free-Point 10 element lever selection.
- ★ Dual Short-Check Sensitivity. ★ Ballast Unit Tests.
- ★ Tests Each Section of Multi-Section Tubes.
- ★ Noise and Condenser Test pin jacks.
- ★ Hi-Speed Roll Chart ★ Micro-Line Adjustment.
- ★ 5 1/4" PACE Meter, 2% Accuracy.
- ★ Dynamic "Under-Load" Test for all popular radio A, B, and C dry batteries.

Model 612-P Deluxe: (Illustrated) Modern 2 color satin brushed aluminum panel. Rubbed natural finish, harwood cabinet. Net Price: \$89.50  
Model 612-P Standard. Net Price: \$84.50

PRECISION Test Equipment is available and on display at leading electronic parts distributors. Ask for latest complete catalog.

**Precision Apparatus Co., Inc.**  
70-31 84th STREET • GLENDALE 27, L. I., N. Y.

Export: 458 B'way, N.Y.C., U.S.A. Cables: MORHANEX  
In Canada: Atlas Radio Corp. Ltd., Toronto 10, Ontario

**Always Mention  
RADIO-ELECTRONICS**



**SHORTHORN**  
corner horn  
speaker system

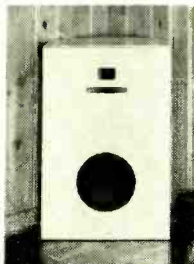

Designed and manufactured by the originator of the Klipschorn speaker system, the Short-horn is second only to the Klipschorn system in performance. Using coordinated acoustic elements, including filters, it offers exceptionally smooth response, free from distortion. Back loading horn extends bass range without resonance.

Available in kit form, with or without drive system. Prices from \$39 for the do-it-yourself horn kit to \$209 for assembled horn with Klipsch Ortho 3-way drive system installed. Write for literature.

**KLIPSCH & ASSOCIATES**  
HOPE, ARKANSAS

# People

Howard W. Sams, president of Howard W. Sams & Co., Indianapolis, was elected chairman of the board. J. A. (Shine) Milling, executive vice president and general manager of the company, succeeds



H. W. Sams

William W. Posey was appointed East Central district sales manager of CBS-Hytron with headquarters in Detroit, Mich. He was formerly with Fitzsimmons Associates and National Union Radio Corp.



W. W. Posey  
national Union Radio

Joseph Solari joined Federal Telephone & Radio Co., Clifton, N. J., as general sales manager of the Components Division. He comes to Federal from Jefferson Electric Co.



J. Solari

Robert L. Wolf was elected vice president in charge of engineering of the Centralab Division of Globe Union, Milwaukee, Wis. He had been director of Centralab products engineering.



R. L. Wolf

Edward E. Wineblatt joined Radio Merchandise Sales, New York, as general manager. He also becomes general manager of their affiliate, Ames Manufacturing Corp. Wineblatt has had wide experience in the parts distributor field.



E. E. Wineblatt has had wide experience in the parts distributor field.

**Obituaries**

Carl V. Haecker, manager of displays and sales promotion for RCA, in Presbyterian Hospital, Philadelphia.

Wallace L. Gifford, a vice president and director of Raytheon Manufacturing Co., Waltham, Mass.

## HERSHEL SPECIALS

**All New MYSTERY PACKAGE**  
of ELECTRONIC PARTS  
Worth \$40.00  
Our Price **\$3.95**  
Ship Wt. 20-lb.

It's the surprise of your life! 20 pounds of brand new usable Gen surplus. The ideal gift for ham, etc.  
We save ship parcel post! to save you more money!

### KIT SPECIALS

<b>KIT 1. HARDWARE</b> Over 1,000 pcs. Assorted For Radio & TV	<b>99c</b>	<b>KIT 2. CERAMICONS</b> 100 Assorted 75 mmd. to 6,000 mmd.	<b>\$2.50</b>
<b>KIT 4. Rotary Switches</b> 25 Assorted Terrific Buy!	<b>\$2.50</b>	<b>KIT 5. RESISTORS</b> 100 Assorted 1 ohm to 15 meg. 1/2 to 5 watts	<b>\$1.75</b>
<b>KIT 6. RF CHOKES</b> 25 Assorted Range from .5MH to 25MH	<b>95c</b>	<b>KIT 7. TOGGLE AND SLIDE SWITCHES</b> 25 Assorted D.P.S.T.-D.P.D.T. S.P.S.T., etc.	<b>\$3.25</b>
<b>KIT 8. PAPER AND CAN CONDENSERS</b> 25 Assorted Range from 4Mfd-150V to 80Mfd.-450V.	<b>\$2.75</b>	<b>KIT 9. KNOBS</b> 100 Assorted Push-On and Set Screw types	<b>\$1.75</b>
<b>KIT 10. MICAS AND SILVER MICAS</b> 100 Assorted Range from 10mmd. to 7500mmd.	<b>\$2.50</b>	<b>KIT 11. BATH-TUB OIL CONDENSERS</b> 25 Assorted Range from .1 Mfd. to 2 Mfd. up to 400 VDC	<b>\$1.50</b>
<b>KIT 12. HI WATTAGE RESISTORS</b> 20 Assorted Range from .75 ohm to 20,000 ohm, 10 up to 200 watts	<b>\$3.25</b>	<b>KIT 13. TUBE SOCKETS</b> 50 Assorted 4-5-6-7-8-9 pin types	<b>\$2.50</b>

**MAKE YOUR XMAS GIFT SELECTION EARLY**

<b>SQUIRREL CAGE BLOWER</b> 28V 7500 RPM will operate A.C. 110 Volts DC 110 ohms with 120 watt resistor 7" x 4" x 4"	<b>\$3.95</b>	<b>VARIABLE CONDENSERS YOUR CHOICE</b> TYPE A 100 M.MFD. Double Spaced size 2 3/4" x 3 1/2" W x 1 1/2" H Hammarlund Mfg. Vacta Root Counter 1/2" Shaft 0-10 Manual for coil tuning, etc. 3 for \$1.00	<b>95c</b> <b>39c</b>
<b>OIL CONDENSER</b> 2 Mfd. 3000 VDC. Pyraloid Oil w/ Mounting Brackets 1-1 Mfd. 3000 VDC. New removed from equip. Size 4 3/4" x 4 1/4"	<b>\$1.65</b>	<b>ARC-5 COMMAND TRANSMITTER YOUR CHOICE</b> 2.1 to 3 MC. 7 to 9.1 MC. Brand New in Cartons. with tubes.	<b>\$6.95</b>

**AUDIO CHOKE**  
1500 ohm ideal for radio control air-planes, boats, etc. Size 1 1/2" x 5/8" x 5/8". Wt. 1/2 oz.

**95c**

**HERSHEL RADIO CO.** 5249 GRAND RIVER  
Detroit 8, Michigan Phone TYler 8-9400

**stop knockin' yourself out!**

let the **MASTER** make life easier for you . . . see pg. 155

# Sensational AND Amazing!

## ARE THE ONLY WORDS THAT DESCRIBE THE MILLER #595 NEGATIVE MUTUAL COUPLED BROADCAST BAND-PASS CRYSTAL TUNER

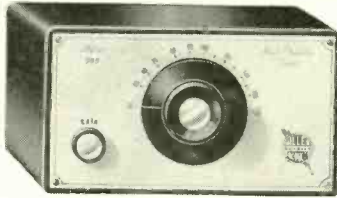

Only 4" x 7" x 3 1/2" Deep

The most amazing High Fidelity Broadcast tuner ever offered to music lovers anywhere. High Fidelity fans will be pleasantly surprised with the tonal quality, selectivity, and sensitivity of this marvelous tuner. The frequency response is limited only by the audio system used, and the transmitted signal.

Mount the tuner on your television set, use your television antenna, and play it through the audio section of the same television set.



Like all Miller products this #595 tuner is guaranteed to perform to your satisfaction. Buy with confidence from your Radio and TV Parts Distributor, Audio Distributor, or High Fidelity Dealer.

It is one of the lowest priced quality tuners on the market. The #595 tuner is complete in every detail, ready to plug into your audio system. Net weight 1 lb. 8 ozs. Shipping weight gross 2 lbs. Net price only \$19.50 plus excise tax.

**J. W. MILLER COMPANY**  
5917 South Main Street • Los Angeles 3, California

Canadian Representative: Atlas Radio Corp., Ltd., 50 Wingold Ave., Toronto 10, Ont., Canada

NO POWER REQUIREMENTS  
SELECTIVITY • SENSITIVITY • NO NOISE • DOES NOT ATTENUATE HIGH FREQUENCY RESPONSE • NO BIRDIES  
LOW COST • LIFETIME TROUBLE-FREE OPERATION • NOTHING TO CAUSE DISTORTION • GAIN CONTROL AND VERNIER TUNING DIAL

The audio output of the tuner is proportional to the input signal and will vary from .07V to .7V for stations within a 20-25 mile radius. We recommend a good antenna and a high quality audio system for best results.

A beautiful ebony black bakelite cabinet houses the tuner with a Richlow brass etched panel for the escutcheon. Both combine to complement any decor.

## it's easy...it's exciting TO BE A HAM!



**GREAT NEW BOOK TELLS YOU HOW**

"So You Want to Be a Ham"

by Robert Hertzberg  
W2DDJ

Know the thrill of being a Ham! Span continents, talk to people in foreign countries, "chew the fat" with fellow hams, help in times of disaster. This new book shows you easier than ever before, how you can be a ham operator. Gets you off to the best start—shows you how easy it is to learn the code and get your ticket; how to select equipment at lowest cost; how to be an amateur equal to the best; how to capitalize on ham knowledge in military or civilian careers. Written by an outstanding expert—practical, easy to understand. 12 fact-packed chapters; 196 exciting pages; 130 illustrations; 5 1/2 x 8 1/2". Order HAM-1, only. . . . . **\$2.50**

Order today from  
**HOWARD W. SAMS & CO., INC.**  
Dept. 2-M5  
2201 E. 46th St., Indianapolis 5, Ind.

## for faultless playback of pre-recorded tape!

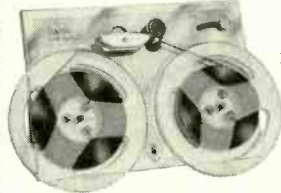

PROVIDING FULL FIDELITY PERFORMANCE—40-14,000 CPS at 7.5"  
**\$59.95**  
USER NET



- Meets broadcast requirements for minimum distortion, flutter, and wow.
- The Viking innovation of a belt-driven capstan eliminates vibration and flutter—*tape speed is constant!*
- The basic monaural unit pictured can be easily converted to full fidelity binaural playback or erase-record playback, ideal for tape duplicating.
- Check Viking's coordinated line of NARTB standard pre-amps, erase bias oscillators, record/playback amplifiers.



Sold thru dealers; write for information

**VIKING OF MINNEAPOLIS**

Dept. RE-12

3520 E. 43rd St., Minneapolis, Minn.

PEOPLE

(Continued)

Edward L. Nelson, a former radio development engineer with Bell Telephone Labs., in Arlington, Va. He had been technical director of the Signal Corps Engineering Laboratory at Fort Monmouth, N. J.

### Personnel Notes

. . . Peter Maler, who has had an extensive background in the marketing and promotion of electronic components, joined Astron Corp., East Newark, N. J., as sales promotion manager.

. . . Percy L. Spencer, vice president of Raytheon Manufacturing Co. and general manager of its Microwave and Power Tube Operation, has been elected a director of the company.

. . . Dr. William Shockley, inventor of junction transistors while with Bell Telephone Labs., joined Beckman Instruments, Fullerton, Calif., where he will direct a group of scientists in developing new uses for semiconductors.

. . . Martin W. Rogers is now director of quality control for National Co., Malden, Mass. He previously held a similar position with Raytheon.

. . . William J. Bakrow was appointed public relations manager of CBS-Hytron, Danvers, Mass. He formerly headed public relations for the Rochester Products Division of General Motors.

. . . F. L. Radford, assistant credit manager of United Motor Service Division of General Motors, Detroit, was promoted to credit manager.

. . . Donald Jonson was named sales supervisor of the Electronics Division of Elgin National Watch Co., Elgin, Ill. He was formerly sales representative for the company's Wadsworth-Hadley Division.

. . . Harold Harris, vice president of sales and engineering of Channel Master Corp., Ellenville, N. Y., has written *Treasure Tales of the Shawangunks and Catskills*, a collection of legends and folklore about the surrounding mountain country.

. . . C. Harvey Bradley, Jones & Laughlin Steel Corp., and James A. Roemer, Mallory-Sharon Titanium Corp., were elected to the enlarged board of directors of P. R. Mallory & Co., Inc., Indianapolis, Ind.

. . . Frederick C. Bash was appointed to the newly created post of product manager of the Atomic Frequency Standards Dept. of National Co., Malden, Mass. He comes to National from Magnavox.

. . . Brig. Gen. David Sarnoff, chairman of the board of RCA, was awarded the 1955 Gold Medal of the Hundred Year Association of New York for his work in electronic communication. He also made the principal address and received an honorary Doctor of Science degree from Notre Dame University at the dedication of its new TV station WNDU-TV.

. . . John Havercamp was appointed Midwestern district sales manager with headquarters in Cedar Rapids, Iowa, for Walsco Electronics Corp., Los Angeles.



## OPPORTUNITY ADLETS

Rates—45c per word (including name, address and initials). Minimum ad 10 words. Cash must accompany all ads except those placed by accredited agencies. Discount, 10% for 12 consecutive issues. Misleading or objectionable ads not accepted. Copy for February issue must reach us before December 15, 1955.

**Radio-Electronics**  
25 W. Broadway, New York 7, N. Y.

ENGINEERING DEGREES earned through home study. American College of Engineering, Box 27724 (M), Hollywood 27, Calif.

HIGH-FIDELITY SPEAKERS REPAIRED. Amprite Speaker Service, 70 Vesey St., New York 7, N.Y.

BUY Surplus Radio, Electronic Equipment direct from Government. List \$1.00. Box 169RAC, East Hrid 8, Conn.

EXPERIMENTERS—HOBBYISTS—BUILD PROJECTS IN THIS MAGAZINE. Paris available for most articles. Free price list of our Part-Paks. Write Box 481, Camden, N.J.

SPEAKER RECONING: Guaranteed workmanship. C&M Recone Co., 255 Floga St., Trenton 9, N.J.

RCA, Motorola, Link, GE and Kaar new and used two-way radio equipment bought and sold. Communications Associates, 138-17 Springfield Blvd., Springfield Gardens, N. Y. Phone LA 7-2727.

DEFINITELY SUPERIOR repair television engineers everywhere, comparing the OCTO-TENNA with other antennas. Sample \$3.50. Postpaid. DERRI, 1018 Taylor, Vallejo, Calif.

DIAGRAMS FOR REPAIRING RADIOS \$1.00. Television \$2.00. Give Make, Model. Diagram Service, Box 672-RE, Hartford 1, Conn.

BIG MAILS—ALL TYPES OF OFFERTS: Your name in our Directory. Once 10¢, 3 listings 25¢. DON ENTERPRISES, Box 186-A, Hialeah, Fla.

NEW printed circuit Television antenna, Ekeradio Electronic Developments, 646 N. Fair Oaks Ave., Pasadena, Calif.

SPECIAL: New English COLLARO RC-54 changer, mounting board, plus-in-head, \$38.75 prepaid. Guaranteed: DIAMOND-SAPPHIRE Stylius RPX-050, \$10.75. Simulated base-cover for all changers, \$9.75. 3% - 7 1/2 - 15 lbs Dual Tracks, 30-15,000 cps English High Fidelity Tape Deck, Three 4 pole motors. Best buy \$79.50 prepaid. WRITE TODAY. Dept. RE, FIDELITY UNLIMITED, 63-03 39th Ave., Woodside 77, N.Y.

TUBES—TV, RADIO, TRANSMITTING, AND SPECIAL PURPOSE TYPES BOUGHT, SOLD AND EXCHANGED. Send details to R. E. Gensler W2LN1, 512 Broadway, N.Y. 12, N.Y.

ALL MAKES OF ELECTRICAL INSTRUMENTS AND TESTING equipment repaired. Write for free catalogue on new and used instruments at a savings. Hazleton Instrument Co., 128 Liberty Street, New York, N. Y.

TRADING TV SETS \$14. Jones TV, 1115 Rumber, Pottstown, Pa.

TAPE RECORDERS, tapes: Wholesale prices. KARSTAN, 215 E. 88 St., New York 28, N.Y.

WANTED: AN/APR-4, other "APR.", "TS-", "IE-", ARC-1, ARC-3, ART-13, BC-348, etc. Microwave Equipment. Everything Surplus, Special tubes, Tee Manuals, Lab Quality Equipment, Meters, Fast Action, Fair Treatment. Top Dollar! Littlell, Fairhills Box 26, Dayton 9, Ohio.

YOUR choice \$1.35 postpaid: T49C radioisone transmitter less tube, 25 assorted mica capacitors, 100 insulated carbon resistors, 10 assorted switches or 20 wirewound resistors. All five for \$4.95; bargain list on request. PALMER, 1440 Las Salinas Way, Sacramento 21, Calif.

DIAGRAMS: Professional Model Timers, Counters, Instruments, Organs, etc. \$1.00 each. List free. Parks, 101 S. E. 57th, Portland 15, Oregon.

PRINTING—Letterheads, 6% envelopes, statements, 250 for \$2.50. Postpaid. POOR BOY RE, Box 1055, Little Rock, Ark.

RADIO, RADAR, TELEVISION instruction leading to Licenses. Port Arthur (Texas) College.

GERMANIUM DIODES, new, large quantities, suitable for constant set, manifold, etc. Sample 100 package \$10.00. DOUGLAS PRICE, Claybrooke Grange, Rugby, England.

RADAR—Correspondence course, including Loran, Sonar, and Microwave now being offered. Inquire, Progressive Electronics Institute, P.O. Box 2764, Los Feliz Station, Los Angeles 27, Calif.

SPICES in a wink! NO SCISSORS! NO RAZOR BLADES! with GIBSON GIRL TAPE SPLICERS. Diagonal cuts tape ends and trims splice edges with the "Gibson Girl" shade. Model TS-4 \$8.50 list. Model TS-4 Deluxe \$11.50 list. At your dealer or write: ROBINS INDUSTRIES CORP., Dept. RE, 41-08 Bell Blvd., Bayside 61, N. Y.

CODE speed information free. DON ROGERS, Dubois Ave., Ivyland, Pa.

DO-It-Yourself Geiger Counter Kit complete with Meier, Neon Headset. Best 3-range sensitivity. Write SIERRA SCIENTIFIC, Dept. 5, 5415 York Blvd., Los Angeles 42, Calif.

25-50% DISCOUNT, guaranteed. Factory Fresh LP records; 69c and up; pre-recorded tapes. Send 20c for catalogue. SOUTHWEST RECORDS, 1108 Winburn, Houston, Texas.

TAPE RECORDERS WHOLESAL. Free bargain catalog. TOWERS, Box 155, Philadelphia 5, Pa.

TV FM ANTENNAS, ALL TYPES INCLUDING UHF. Mounts, accessories. Lowest prices. Wholesale Supply Co., Lunenburg 2, Mass.

## PEOPLE

(Continued)

... Richard L. Beam was elected vice president in charge of engineering for Hazeltine Electronics Corp., Little Neck, N. Y. He was formerly an assistant vice president. Webster H. Wilson, also an assistant vice president, was elected vice president in charge of the Government and Commercial Dept.

... Gramer Yarbrough, sales manager of American Microphone Co., was appointed head of the committee for the 1956 Los Angeles High-Fidelity Music Show.

... R. M. Macrae, Northeastern region manager of RCA, was appointed vice president in charge of distribution for RCA Victor Co., Ltd., Montreal, Canada. Raymond W. Saxon, formerly general sales manager of the RCA Victor Television Division, succeeds him. Joseph P. Bannon, field manager of the division, advances to Saxon's former position.

... Raoul Du Chatellier was promoted to export manager of Sola Electric Co., Chicago. Prior to this appointment he had been assistant export manager.

... Morris Harris was appointed resident counsel of Allen B. Du Mont Labs., Clifton, N. J. He had been production control manager of the Technical Products Division.

... Wayne Cargile of Permo, Inc., was named chairman of the Industry Relations and Publicity Committee of the Association of Electronic Parts and Equipment Manufacturers. Other chairmen and their committees include: Ted Rossman, Pentron Corp., Industry and Conference Coordinating; Ernie Necker, Argos Products, Program; Norman Ackerman, Perma-Power, Membership and Attendance; Robert Reigel, Chicago Standard Transformer, Educational; Vic Machin, Shure Bros., Survey; Robert E. Jacobsen, Rauland Corp., Credit; and Bill Halligan, Jr., Hallcrafters, Social.

... Dr. W. R. G. Baker, General Electric Co., was reappointed chairman of the RETMA Television Committee and the Special Committee on Spurious Radiation. He was also named to head the group appointed to study TV frequency allocation problems. J. A. Milling of Howard W. Sams & Co. was reappointed chairman of the RETMA Jobber Relations Committee and Ellis L. Redden of Magnavox was named head of Public Relations and Advertising.

... Col. Richard H. Ranger, Ranger-tone, was elected president of the Audio Engineering Society.

... Dr. Elmer W. Engstrom, RCA, received the Progress Medal Award of the Society of Motion Picture and Television Engineers at its recent Convention in Lake Placid, N. Y. Others honored included Dr. Harry F. Olson, RCA, the Samuel L. Warner Memorial Award, and Bernard D. Laughlin of Hazeltine Corp., the 1955 David Sarnoff Gold Medal Award.

... Gene Gold joined Granco Products, Long Island City, as merchandising manager. He comes to the company from Audio & Video Products. END

## LEARN ELECTRONICS & COLOR TV in K.C.

UNIVERSAL TV ... Famous for 25 Years  
Thousands of Successful Grads

ELECTRONICS—the world's GREATEST new industry is years ahead of its manpower supply. ELECTRONICS JOBS ARE SEEKING TRAINED TECHNICIANS, an acute shortage of which exists today. Big companies are actually pirating men from one another because there aren't enough trained electronics experts to go around to fill the many jobs.

Wide Scope Electronics Course at UNIVERSAL: Embraces Radio, Monochrome-Television, Color TV, Industrial Electronics, Industrial Television, Atom-electronics and Automation. Automation, a terrific new field, embraced at UTS.

25 Years EXCLUSIVELY in Electronics:

For a quarter of a century UNIVERSAL TV has been training and placing grad technicians in fascinating big-pay jobs from coast to coast. You can start earning as much as \$150 per week; no limit as time goes on, or you can open your own business.

UNIVERSAL not a Johnny-come lately school:

Not a home study or correspondence training, but a "genuine" old established resident school staffed by expert instructors and headed by America's first TV broadcasters. Costs so little to prepare yourself for life. Many middle age trainees attend; go into successful business. No previous experience needed. Approved for vets and non-vets. Write for Send coupon for FREE BOOK on TV & electronic opportunities.

WRITE FOR  
**FREE CATALOG**

FILL OUT COUPON

UNIVERSAL TV SCHOOL

1222R Admiral Boulevard, Kansas City, Missouri

PLEASE SEND ME INFORMATION FREE. Age—

Name

Address

City

State

Check here if Korean Veteran

WANT POWER & VERSATILITY?

**FOLLOW THE LEADER...**



©55



**KIT**  
**\$29.95**

Wired  
**\$38.95**

**6V & 12V BATTERY ELIMINATOR & CHARGER #1050**

- operates 6V and 12V auto radios for servicing and sales demonstration.
- charges 6V and 12V storage and Edison Batteries.
- operates mobile and marine receivers, transmitters, boat lights, electric trains, projection and other equipment.

### SPECIFICATIONS

- 6-Volt range: 0-8V (up to 20 Amp.)
- 12-Volt range: 0-16V (up to 10 Amp.)
- variac-type transformer for continuously variable voltage adjustment.
- reads volts and amperes at same time on 2 separate meters.
- Transformer primary and secondary fully protected.

In stock at local jobbers throughout the world. Write for free Catalog CB-12.  
Prices 5% higher on West Coast

**EICO**

84 Withers Street  
Brooklyn 11, N. Y.

Announcing the first

# BASIC

books ever to be published  
on Synchros and Servos!

## "BASIC SYNCHROS AND SERVOMECHANISMS"

by Van Valkenburgh, Nooger & Neville, Inc.

A NEW 2-VOLUME "PICTURE BOOK"  
SERIES DERIVED FROM THE U.S.  
NAVY'S TRAINING PROGRAM!

Synchros and servomechanisms are the heart of Automation! In addition to wide military use (aiming guns, controlling ship's rudders, etc.) they do an ever-increasing variety of tasks for industry . . . faster and more accurate than is possible manually.

To understand what Automation is . . . what it can do . . . you must know the basics of these important devices—and nothing tells the story like these Rider Picture Books! As with our easy-to-understand "Basic Electricity" and "Basic Electronics" series (described below) "Basic Synchros and Servomechanisms" is derived from the U.S. Navy's present training program; tried, proven, and successfully used to train more than 25,000 Navy men in record time.

Here's how easy it is to learn: every page covers one complete idea. On that same page, there's at least one big, crystal-clear drawing to illustrate and explain it. Using simple, everyday English, these new Picture Books guide you along a carefully planned, step-by-step explanation of the basics of synchros and servomechanisms, making everything picture clear. The way these books tell their story—everyone can understand! Order your set now!

"Basic Synchros and Servomechanisms" consists of 2 (6" x 9") paper bound volumes, totaling 270 pages, with more than 300 illustrations.

2 VOLUME SET . . . . . ONLY \$5.50

## LEARN BASIC ELECTRICITY AND BASIC ELECTRONICS THE EASY PICTURE BOOK WAY!

### "BASIC ELECTRICITY" "BASIC ELECTRONICS"

by Van Valkenburgh, Nooger & Neville, Inc.

The fabulous Picture Book training courses derived from the Navy's Basic Electricity-Electronics training program! Over 1,700 big clear pictures to guide you every step of the way! 25,000 Navy students have successfully mastered the fundamentals of these vital subjects in record time . . . and now YOU can do the same! Imagine—a complete idea on every page—at least one big drawing on that same page to illustrate and explain it—review pages at the end of every section to highlight the subjects just covered. There's never been an easier, better way to learn basic electricity and electronics!

"BASIC ELECTRICITY" 5-vol. set . . . . . Only \$9

"BASIC ELECTRONICS" 5-vol. set . . . . . Only \$9

### ORDER TODAY!

Rider books are sold by electronics parts jobbers and book stores throughout the country. If YOUR dealer doesn't have them, mail this coupon to us!

JOHN F. RIDER PUBLISHER, INC.  
Dept. RE-12, 480 Canal St., N.Y. 13, N.Y.

Enclosed is \$ . . . . . Send me:

- Basic Synchros & Servomechanisms 2-vol. set \$5.50
- Basic Electricity . . . . . 5-vol. set \$9.00
- Basic Electronics . . . . . 5-vol. set \$9.00

Add state & city sales tax where applicable.  
In Canada, prices approx. 5% more.

Name . . . . .

Address . . . . .

City & State . . . . .

# Business



## Merchandising and Promotion

Weller Electric Corp., Easton, Pa., launched a fall and winter promotion on its soldering guns and power sanders. The program includes an adver-



tisement in *Life* magazine, backed by space in hobby and trade magazines including RADIO-ELECTRONICS. The company also designed a display rack for point-of-sale promotion.

Westinghouse Electric is sponsoring a "Don't do it yourself" campaign to discourage TV set owners from doing their own repairs. Commercials on the TV program "Studio One" headline the campaign which is being followed through by direct mail at the dealer level.

International Rectifier Corp., El Segundo, Calif., designed a new *Bonus Pack* containing a pair and a spare pair of its TV replacement rectifiers. A

Ask for the

## International Bonus Pack!

Buy 4 TV Replacement Selenium Rectifiers . . . . .  
A FREE TOOL & SPARE PAIR

Free

GET THE BEST  
SELENIUM RECTIFIER . . . . .  
SPECIFY  
**International Rectifier**

premium, a nylon TV alignment tool, is included in the plan which is being backed up by an extensive direct-mail program.

General Electric, Syracuse, N. Y., has

## World's First F-M Pocket Radio



(THIS IS THE 5th year) USING A PRINTED CIRCUIT. Tunes 88 to 107.6 megacycles, self contained. Operates on miniature batteries inside the case. NO ANTENNA OR GROUND NEEDED. CAN BE USED AS A TUNER WITH YOUR CAR RADIO OR ANY AMPLIFIER. (BE THE FIRST IN THE NEIGHBORHOOD TO OWN ONE.) THE COMPLETE KIT WITH A HIGH FREQUENCY TUBE AND A CLEAR PLASTIC CASE

ONLY \$9.95

SPECIAL EAR-PIECE \$5.95 batteries \$3.50

new now a printed CIRCUIT T-V ANTENNA

(smaller than a TRANSISTOR ONLY \$1.98. ALL WAVE RADIO KIT TUNES BROADCAST AND 160 to 19 meters only 4 1/2 oz. \$5.95. TWO BAND 8 oz. BATTERY EMERGENCY RADIO RECEIVER ONLY \$24.95 READY TO PLAY WITH BATTERIES AND EARPIECE.

## EKERADIO ELECTRONIC DEVELOPMENTS

646 N. Fair Oaks Ave., Dept. "G", Pasadena, California

## For Rent—January 1st

614 W. RANDOLPH ST.

Well-known address for Radio jobber

J. BEIDLER CAMP & CO.

546 W. Washington Blvd. Chicago 6, Illinois  
Ran 6-0763

RADIO-ELECTRONICS is paying good rates on acceptance for original and unusual articles on audio, television, FM and AM servicing, as well as articles on industrial electronic equipment and application. Send for a copy of our Authors' Guide. Address:

### THE EDITOR RADIO-ELECTRONICS

25 West Broadway, New York 7, N.Y.

## TV TUNER REPAIRS

### 48-HOUR SERVICE

Defective tuners rebuilt to factory standards. New tuner guarantee. Ship prepaid.

### RADIO PRODUCTS CO.

College Point 56 • New York  
We carry a full stock of  
Replacement Tuners for all makes of T.V.

## Radio-TV-Electronics

Find out what an FCC License (U. S. Govt.) is and how it will insure your future success and security.

It will lead to military promotions and advancements. It will enable you to convert your military job to a valuable civilian occupation!

### Send For These 3 FREE Books Now

1. How To Pass FCC Exams
2. Money-making FCC Information
3. Master Course Sample Lesson

The industry prefers an FCC licensed technician. With an FCC license YOU will qualify for the REALLY GOOD jobs!

WRITE TODAY

### CLEVELAND INSTITUTE OF RADIO ELECTRONICS

Desk RE-84 4900 Euclid Bldg.  
Cleveland 3, Ohio

designed a special counter display card for its low-priced transistors for hobbyists.

United Motors Service Division of General Motors, Detroit, is co-sponsor-



ing the hour-and-a-half NBC TV show, "Wide, Wide World."

Wendell Plastic Fabrics Corp., New York, has designed a smaller sized package and display for its Mellotone grille fabric.

Astatic Corp., Conneaut, Ohio, has embarked on a new three-point merchandising program for its line of phonograph cartridges. A new stock

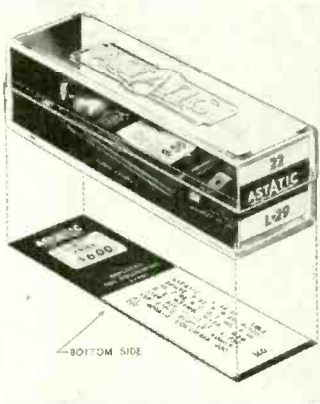

numbering system has been devised and both the old and new numbers are shown on the cartridge box which also carries complete replacement data and the list and dealer net price.

**Production and Sales**

RETMA reported manufacturers' sales of 6,478,351 TV picture tubes and 300,080,000 receiving tubes for the first eight months of 1955. This compares with 5,326,775 TV picture tubes and 225,085,000 receiving tubes for the 1954 period.

RETMA reported the production of 4,820,991 TV sets during the first eight months of 1955, 27% more than for the same period last year. Radio set production of 8,725,012 was 43% ahead of the figures given for the first eight months of last year.

The Bureau of Census of the U. S. Department of Commerce reports that there are now about 32,000,000 households in the U. S. with TV sets as of June, 1955—a total of 67% of all the homes in the nation. In 1950 there were 5,000,000 homes or 12% of the total with TV sets.

If you qualify, here is the  
**KEY TO YOUR FUTURE**

**The future is bright for  
ELECTRONIC ENGINEERS  
and  
TECHNICIANS**

ERA's leadership in creative research and important developments in mechanical and electrical engineering fields is internationally known. Interesting positions are opening up fast for experienced electronic engineers and technicians. Join and grow with ERA. Steadily enlarge your computer knowledge and professional standing.

**FIELD ENGINEERING** . . . A special extended training program at full salary is offered to men who choose computer field engineering. Take your family with you to permanent computer installations.

To qualify, send an outline of your training and experience to Department D-21

**Remington Rand**  
DIVISION OF **SPERRY RAND** CORPORATION

**ENGINEERING RESEARCH ASSOCIATES** DIVISION  
1902 West Minnehaha Avenue • Saint Paul W-4, Minn.

**CROWN**  
Professional Tape Recorder

**CROWN PRINCE**  
Breaks Sound Barrier  
20-20,000 CPS usable at 7 1/2 IPS

The only Complete Professional Recorder as a single easily portable unit using 10 1/2" reels . . . Three speeds: 15, 7 1/2, 3 3/4 IPS . . . 10 1/2" Reels—can be rack mounted . . . Hi-Z Mike and Phono Input . . . Cathode Follower Output . . . Size: 19" x 14" x 7 1/2". Wt., 38 lbs.

Dual Track—\$349.50      Full Track—\$399.50

Complete less case  
Write for literature.  
Address Dept. RE-12

**INTERNATIONAL RADIO & ELECTRONICS CORP.**  
Elkhart Indiana

**SPECIFICATIONS**

- "Micro-Linear" Heads
- Three Speeds
- Three Motors
- Meets NARTB Standards
- "Micro-Sync" Timing
- Straight Line Threading
- 4" Dual Lighted Meter
- Magnetism Braking
- Perfect Erasure

★ ★ ★ ★

**GUARANTEED**

Record & Playback Performance

IPS	15	7 1/2	3 3/4
% WOW	.12	.18	.25
DB	± 2	± 2	± 3
CPS	20 to 22,000	30 to 16,000	30 to 10,000
NOISE RATIO	55	52	44

for Full Track Heads

**XCELITE Hand Tools**  
PREFERRED BY THE EXPERTS

**No. 99 Junior Kit**



**NOW!**

**OFF-THE-SHELF DELIVERY  
ON THIS POPULAR KIT!**

Here's good news for those of you who haven't been able to get this new 99 Junior kit. Our new plant addition is turning it out full tilt and it's on distributors' shelves. ASK YOUR SUPPLIER to show you this pocket-size roll plastic kit with all its tools (3/16, 7/32, 1/4, 9/32, 5/16, 11/32 and 3/8" nut driver bits—Nos. 1 and 2 Phillips screwdrivers—3/16 and 9/32 slotted screwdrivers). Also ask about the new chrome-plated SUPREEMER.

**XCELITE, INCORPORATED**  
Dept. J  
ORCHARD PARK, N. Y.

*For Originality*  
**LOOK TO XCELITE**

**COUNT WITHOUT NUMBERS**

more of are on  
laws thought based counting  
than we recognize. Logic Mirror-Wise,  
4 pages. **Send 25c**  
W. J. MALLORY, 616 N. 34th St., Omaha 3, Nebr.



**\$2.95 EACH or 2 For \$5.00!**

Genuine Telephone Company Upright  
Telephones. Complete with cords. In  
tested and guaranteed condition with 50  
ft. of wire. intercommunication instruc-  
tions. Complete line of telephones and  
parts, dial magnets, extension, inter-  
communication, army surplus communi-  
cation equipment, etc. Write for free list.  
All shipments F.O.B. Simpson, Pa.

**TELEPHONE ENGINEERING CO.**  
Dept. 12CS  
SIMPSON, PA.

**AUDEL TV TELLS HOW TO ANSWER RADIO T.V. QUESTIONS**  
**RADIO T.V. SERVICE LIBRARY**

HERE IS LATE INFORMATION IN A  
HANDY FORM FOR TELEVISION AND RADIO  
REPAIRMEN, SERVICEMEN AND STUDENTS



**AUDEL'S T.V. RADIO SERVICE LIBRARY**—  
Highly Endorsed—Over 1500  
Pages—1048 Illustrations &  
Diagrams. 1001 Important  
Facts & Figures on Modern  
Television, Radio, Electronic  
Devices at your finger ends.

**INCLUDES TRANSISTORS**  
& Transistor Circuits, Record  
Changers, Rectifiers, P.A.  
Systems, Tape Recorders, Pho-  
nograph Pick-ups, F.M., Auto  
Radio, Radio Compass, Short  
Wave, Radar, etc.

**ASK TO SEE IT!**  
**IT WILL PAY TO KNOW—**  
The Basic Principles—Con-  
struction—Installation—Oper-  
ation—Repairs—Trouble Shoot-  
ing. Shows How to get Sharp,  
Clear T.V. Pictures. Install  
Aerials—How to Test. Ex-  
plains Color Systems, Methods  
of Conversion, Terms, etc. In-  
cludes Ultra High Frequency  
—Valuable for Quick Ready  
Reference and Home Study.

**\$6 COMPLETE**  
**2 VOLUMES**

Get this Information  
for Yourself.

**7 DAY TEST—PAY ONLY \$1 A Month**  
**MAIL ORDER**

**AUDEL Publishers, 49 W. 23 St., N.Y. 10, N.Y.**  
Mail AUDEL'S T.V. RADIO SERVICE LIBRARY (2 Volumes) \$6  
on 7 days free trial. If O. K. I will remit \$1 in 7 days and  
\$1 monthly until \$6 is paid. Otherwise I will return them.

Name \_\_\_\_\_  
Address \_\_\_\_\_  
Occupation \_\_\_\_\_  
Employed by \_\_\_\_\_ **RE**

**ONE Generator covers 150 kc—435 mc!**  
**WORLD'S BEST GENERATOR BUY!**



**New! EICO SIGNAL GENERATOR #324**  
**KIT \$26.95** **Wired \$39.95**

- 6 fundamental bands: 150-400 kc, 400-1200 kc, 1.2-3.5 mc, 3.5-11 mc, 11-37 mc, 37-145 mc, 1 harmonic band 111-435 mc. Covers AM, FM, TV, & Amateur freqs.
- ±1.5% frequency accuracy; 6:1 vernier tuning knob & excellent spread at most important alignment frequencies.
- Etched tuning dial, plexiglass windows, edge-lit hairlines.
- Variable depth of int. mod. 0-50%, by 400 cps Colpitts osc.
- Variable gain ext. mod. ampl.; only 3.0 v for 30% mod.
- Colpitts RF oscillator plate-modulated by cathode follower.
- Turret-mounted, slug-tuned coils.
- Fine & Coarse (3-step) RF attenuators; 50-ohm output Z.
- RF output 100,000 uv; AF output to 10 v.

In stock at local parts distributors coast to coast.  
Write for free Catalog **CG-12**

**EICO**® Prices 5% higher  
on West Coast  
84 Withers Street • Brooklyn 11, N.Y. © 55

BUSINESS

(Continued)

**New Plants and Expansions**

**General Cement Manufacturing Co.**, has consolidated the operations of five of its subsidiaries in a newly acquired five-story building in Rockford, Ill. G-C Electronics, Television Hardware Manufacturing Co., Telco Electronics, Geelar Manufacturing Co. and Wood Specialty Manufacturing Co., all are now located at 400 S. Wyman St. The Chemical Division will continue at the present location at 919 Taylor Ave.

**I.D.E.A. Inc.**, Indianapolis, acquired control of Radio Apparatus Corp., of the same city, through the exchange of common stock. It will be operated as the Monitoradio Division of I.D.E.A.

**RCA** has completed plans for acquiring a 285,000-square-foot building at Lancaster, Pa., for the production of color TV picture tubes. The RCA Tube Division has begun construction on a \$3,000,000 plant to manufacture semi-conductors in Bridgewater Township, N. J.

**Federal Telephone & Radio Co.**, Clifton, N. J., is constructing a new plant in Los Angeles for the production of electronic equipment for the aircraft industry.

**Daystrom Inc.**, Elizabeth, N. J., has sold the assets, name and business of its subsidiary, American Type Founders, in order to concentrate on the electronic and electrical fields.

**Elgin National Watch Co.**, Elgin, Ill., is combining the relay engineering and research activities of its subsidiaries, Advance Relay Co., Burbank, and Elgin-Neomatic, Los Angeles, in newly leased facilities in Burbank.

**Service Instruments Co.**, manufacturer of test equipment and television accessories, moved from Chicago to Addison, Ill.

**CBS-Hytron Sales Corp.**, Danvers, Mass., was established as a subsidiary of CBS for the promotion and sale of CBS tubes and semiconductors in the distributor market.

**Sylvania Electric Products** has begun construction on its new Data Processing Center at Camillus, N. Y.

**Telectronic Corp.** has added another floor to its facilities at Long Island City, N. Y.

**Reiner Electronics Co.**, Easton, Pa. will build an additional building adjoining its present facilities.

**Business Briefs**

... **RETMA** president, H. Leslie Hoffman, predicted a new TV set production record of 8,200,000 sets this year. Other industry leaders including Ross D. Siragusa, Admiral Corp.; John S. Coleman, Burroughs Corp.; Frank Stanton, CBS, and Frank M. Folsom, RCA, predicted

that the electronic industry would be a \$30 to \$35 billion business by 1975, and that there would be 92,000,000 TV sets in the U. S., of which 90% would feature color.

... 50 21-inch RCA color TV sets were installed in the Governor Clinton Hotel in New York City.

... Sylvania Electric Products recently produced its 10-millionth TV picture tube at its Seneca Falls plant.

... RETMA announced six new members were admitted to the association: American Electronics Co., New York; Eltran Corp., St. Anne, Ill.; Ratigan Electronics Inc., Los Angeles; Televideo Corp. of America, Los Angeles; Texas Instruments Inc., Dallas, Tex.; Vega Electronics Corp., West Los Angeles, Calif.

... Technograph Printed Electronics, Inc., Tarrytown, N. Y., licensed RCA to manufacture printed electrical circuits under Technograph patents.

... United Catalog Publishers, New York City, brought out the 20th edition of its buyers guide and reference book which was recently retitled *The Radio-Electronic Master* to give a more accurate picture of its contents.

... Altec Lansing Corp., Beverly Hills, Calif., is holding a series of "road show" sales meetings throughout the U. S.

... 1956 Electronic Parts Distributors Show management reports that in answer to a recent questionnaire the majority of exhibitors and distributors prefer to continue the show in Chicago in May.

... The Institute of High Fidelity Manufacturers, New York City, approved the applications of six new members: Bell Sound Systems; S. B. Marantz Co.; Fenton Co.; Precision Radiation of California; National Co. and the Grommes Division of Precision Electronics Inc.

... Columbia Wire & Supply Co., Chicago, is now backing its 300-ohm *Permaline* television transmission line with written guarantees—15 years for the 50 mil, and 25 years for the 80 mil.

... Tru-Ohm Products Division of Model Engineering & Manufacturing Co., Inc., Chicago, recently produced its 80-millionth resistor.

... Polytechnic Institute of Brooklyn will hold an International Symposium on Nonlinear Circuit Analysis, Part II, in New York, April 25-27, 1956.

... CBS-Columbia, Long Island City, N. Y., has inaugurated a series of training seminars for service personnel of its distributors and dealers.

... ORRadio Industries, Opelika, Ala., manufacturer of *Irish* brand magnetic recording tape, reports that September, 1955, was the best month in its history—90% better than September, 1954.

... An Atomic Exposition will be held Dec. 10-16 in the Cleveland Public Auditorium.

**6-VOLT BATTERY SOLDERING IRON AND WELDER**

U.S. Army release. Brand New—Never Used. Fully Guaranteed. This soldering iron can be used to solder or weld when connected to any six-volt storage battery. Uses approximately 200 to 300 watts. The high intensity arc created between the metal to be soldered and the carbon electrode (carbons supplied free with iron) can be used to heat tin or aluminum solder. Suitable also for light brazing and spot welding. Arc can be used

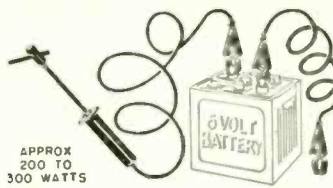

for melting metals, cutting holes and soldering seams in chassis. Also useful for analyzing metals and minerals. Battery soldering iron outfit includes 2 carbons, 3 heavy duty spring clips, 2 pieces 5 ft. heavy duty wire cable. (Battery not included.) Ideal for use where current is not available. Ship wt. 4 lbs.

ITEM NO. 126 UNUSUAL BUY ..... (P.P. & Hdg. Chgs. 50c) **\$1.95**

**VARIABLE SPEED UNIVERSAL MOTOR**

FOR 110 VOLTS, A.C. OR D.C. Used, but in excellent condition. Special lever control permits variable speeds up to 3000 r.p.m. 1/4" shaft extends from both sides of motor. Measures 7 1/2" x 3 3/4" diam. overall. Ship. Wt. 6 3/4" lbs. ITEM NO. 127 Your Price..... **\$2.45** (P.P. & Hdg. Chgs. 75c)



**WATT-HOUR METER**

Leading makes—reconditioned. Ideal for trailer parks. 100-110 volts, 60 cycles, 2-wire A.C. 5 amp. Heavy metal case 8 1/2" x 6 1/2" x 5". Easy to install. Ship. wt. 14 lbs. ITEM NO. 33 **\$4.50** (P.P. & Hdg. Chgs. \$1.25)

**AMAZING BLACK LIGHT**

250-watt ultra-violet light source. Makes fluorescent articles glow in the dark. Fits any lamp socket. For experimenting, entertaining, unusual lighting effects. Ship. wt. 2 lbs. ITEM NO. 87 (P.P. & Hdg. Chgs. 35c) **\$2.45**



**BLAK-RAY SELF-FILTERING ULTRA-VIOLET LAMP**

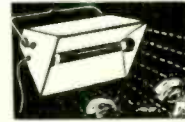

BLAK-RAY 4-watt lamp, model X-4, with U-V tube. Lamp has a wave-length of 3654 to 4000 angstrom units. Some of the substances made to fluoresce are certain woods, oils, minerals, milk-stone, cloth, paints, plastics, yarn, drugs, crayons, etc. Self-filtering and harmless. Equipped with aluminum reflector. 110 volt 50-60 cycle A.C. 2000 to 3000 hours of service. Approved by Underwriters has a built-in transformer. ITEM NO. 125 (Ship. Chgs. 80c) **\$16.75**

**POWERFUL ALL PURPOSE MOTOR**

Sturdy shaded pole A.C. induction motor. 15 watts, 3000 rpm. 3"x2"x1 3/4"; 4 mounting studs; 7/8" shaft, 3/16" diameter; 110-120 volts, 50-60 cycles. A.C. only. ITEM NO. 147 UNUSUAL BUY (P.P. & Hdg. Chgs. 35c) **\$2.45**



**250 POWER TELESCOPE LENS KIT**

Make your own high powered 6 ft. telescope! Kit contains 2" diam., 75" focal length, ground and polished objective lens and necessary eye pieces. Magnifies 50x to 250x. Full instructions. ITEM NO. 123 (Ship. Chgs. 10c) **\$2.95**



**HUDSON SPECIALTIES CO.**  
25 West Broadway, Dept. RE-125  
New York 7, N. Y.

I am enclosing full remittance for items circled below. (Be sure to include shipping charges.)  
OR, my deposit of \$..... Ship balance C.O.D.  
MINIMUM C.O.D. ORDER \$5.00.  
C.O.D. ORDERS ACCEPTED ONLY WITH 20% DEPOSIT. INCLUDE SHIPPING CHARGES.

87 147 33 126 123 125 127  
Name ..... Please Print Clearly  
Address .....  
City ..... Zone..... State.....

**LEARN TV**  
the practical way--



**BUILD the New TRANSVISION TV KIT**

**\$15.00 ONLY** gets you started\*

- PROFIT 3 WAYS:  
1 Learn TV  
2 Save up to 50%  
3 Prepare for COLOR TV

**FREE CATALOG**

**Shows 8 Great TV Kits:**  
EXCLUSIVE: Only Transvision TV Kits are adaptable to UHF. Ideal for FRINGE AREAS. No Previous Technical Knowledge required. Write now!  
**TRANSVISION**  
THE OLDEST NAME IN TV KITS  
NEW ROCHELLE, N. Y.

MAIL THIS COUPON TODAY -  
TRANSVISION, INC., NEW ROCHELLE, N. Y. Dept. RE-12  
 I'm enclosing \$..... deposit. Send standard kit PACKAGE #1, with all Instruction Material. Balance C.O.D.  
 Send FREE copy of your new TV Kit Catalog.  
Name.....  
Address.....  
City..... State.....

**ATLAS Cobra-Jectors**

- wide angle dispersion
- indestructible fiber-glass
- all-weather construction

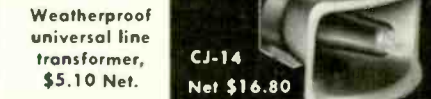

Designed for wide angle coverage, paging, high efficiency intercom, sensitive talk-back. Tops in articulation. Convenient omnidirectional mounting bracket. In appearance, they're "beauts".

SPECIFICATIONS	CJ-30	CJ-14
Input pwr (cont.)	15 w	5 w
Input imp.	4 or 8 ft	4, 8 or 45 ft
Response (cps)	250-9,000	400-10,000
Dispersion	120° x 60°	120° x 60°
Bell Size	14" x 6"	9 1/2" x 5 1/2"
Over-all length	14"	8 1/2"

Amazing "power packages"—use the Cobra-Jectors for the "tough" jobs.

**WRITE FOR COMPLETE CATALOG**  
**ATLAS SOUND CORP.**  
1443—39 St., Bklyn. 18, N. Y.  
In Canada: Atlas Radio Corp., Ltd., Toronto, Ont.

# 1955 ANNUAL INDEX

Vol XXVI

RADIO-ELECTRONICS

(Key to abbreviations on pg 156)

## MORE POWER

**35 Watts—RATED**  
**45 Watts—PEAK**

## LESS DISTORTION

**Under 0.1% at 10 Watts**  
**Under 1.0% at 35 Watts**

## LOWER COST

**\$129<sup>50</sup>**

Slightly higher West of Rockies

# The NEW Pilot HI-FI AMPLIFIER

### Complete with Pre-amplifier and Tone Controls Model AA-905

**MAIL THIS COUPON FOR COMPLETE SPECIFICATIONS**

PILOT RADIO CORPORATION CM-6  
37-06 36th St., Long Island City 1, N. Y.

Please send complete description of the new AA-905. I am also interested in the following literature:

- Pilot AM-FM tuners
- Other Amplifiers
- Pilot Component-Console Systems

Name.....  
 Address.....  
 City..... Zone..... State.....

<b>A</b>	
A.C. Supply Circuitry (Hedge)	Oct 49
A.C. Voltbox* (Turner)	Sep 43
AIEE Goes Electronic (Shunaman)	Apr 58
Abstract Oscillography	Apr 55
Accessory for Your Signal Generator* (Lewis)	Oct 40
Acquiring a Hi-Fi Amplifier* (Leslie)	Oct 58
Adapting the A.C.-D.C. for Intercom Operation* (Guarente)	Nov 48
Adding Feedback to Old Amplifier (Crowhurst)	Oct 61
Adding Tape Recorder Bias-Erase Indicator (DiElsi)	Dec 46
Adding Versatility to Master Intercom Units (Frye)	Apr 44
Again... the Matrix (Middleton)	Nov 34
Aid to Inventors Urged	Aug 59
<b>AMATEUR</b>	
500-Watt Final (QB)	Mar 136
Audio Peaking for CW (REC)	May 126
Automatic CW Keyer (REC)	Sep 139
Crystal Calibrator (REC)	May 126
SSB Receiving Adapter* (REC)	Feb 121
Sure-Fire Oscillator (QB)	Jan 169
T-R Relay for Hams (REC)	Aug 104
<b>AMPLIFIERS (See Audio, Television)</b>	
<b>ANTENNAS—TV (See Television)</b>	
Antenna for Broadcast Reception, Rotatable Loop (Dewar)	Feb 100
Antenna Beams TV Signals 188 Miles	Aug 39
Applying Ultrasonics (Milanowski)	Aug 86
Atom-Bomb Effect (McRoberts)	Dec 91
<b>AUDIO</b>	
<b>Amplifiers</b>	
120-Watt* (QB)	Dec 136
2-Way Transistor (Pat)	Apr 126
4-Input (Stratmoen)*	Feb 86
Acquiring a Hi-Fi (Leslie)	Oct 58
Adding Feedback to Old (Crowhurst)	Oct 61
Ampex 620†	Oct 65
Bogen DO30A†	Mar 65
Electrostatic (Pat)	May 136
High-Power Williamson* (Hafler)	Dec 42
Low-Distortion* (Malamud)	May 61
McIntosh MC-30†	Aug 45
Correspondence on above	Dec 14
Martin 352†	Mar 66
National Horizon 20†	Nov 106
Power, Circuit Features of High-Fidelity (Scott)	Aug 44
Power, Circuit Features in Hi-Fi (Scott)	Sep 79
Correction to above	Dec 128
Regency HF-80†	Jun 39
Remote Transistor* (Neil)	Dec 45
Scott 265-A†	Mar 65
Sherwood Model S-100 20-Watt†	Sep 94
Transplanting (Hansen)	Sep 55
Ultra-Linear, Designing (Miller)	Sep 92
<b>Cartridges</b>	
Electro-Sonic†	May 66
Electro-Voice Ultra-Linear	Aug 48
G-E Baton Tone Arm and†	Mar 66
G-E Golden Treasure†	Feb 81
Pickering†	Jun 41
Ronette Crystal Phono†	Jul 80
Changer, Garrard RC90†	May 63
Damping, Variable (Crowhurst)	Nov 82
Damping, Variable (Scott)	Mar 64
<b>Enclosures</b>	
12-Inch Reflex* (QB)	Jul 104
Bass-Reflex TV Stand (Wheelock)	Aug 42
High Power With Small Speakers (Matsinger)	Nov 98
Karlson, Constructing* (Drenner)	Oct 54
Karlson†	Jan 119
Loudspeaker* (Coates)	Jun 30
Fidelity, Variable-Height (Kenn)	Oct 57
For Golden Ears Only (Monitor) Jan, 119; Feb, 81; Mar, 66; Apr, 39; May, 63; Jun, 35; Jul, 78; Aug, 47; Sep, 84; Oct, 65; Nov, 104; Dec 50	
Gilding Golden Ears* (Marshall)	Feb 91
Correction to above	Apr 120
High-Fidelity Dictionary (Bukstein) Feb, 70; Mar, 76; Apr, 43; May, 87; Jun, 38; Jul, 90	
<b>Intercoms</b>	
Adding Versatility to Master (Frye)	Apr 44
Baby-Listening* (McMath)	Jul 76
FM Wireless (Neil)	Oct 46
Inexpensive (REC)	Oct 138
Multistation (QB)	Aug 106
Starved-Current (REC)	Jun 98
Level Indicator, Dubbing D-500†	Jan 124
Load Line, What Is (Crowhurst)	Jun 33
<b>Loudspeakers</b>	
Missing Link in Operation, Part II (Tomcik)	Jan 106
Hartley 215 and the Bofflet	Apr 39
High Power With Small Speakers (Matsinger)	Nov 98
Horn Type System (Augsburger)	
Part I—Horn speaker fundamentals	Apr 30
Correspondence to above Jul 12; Jul 14	
Part II—Variations in Klipsch design, exponential labyrinth; radial horn	May 82
Klipsch Horn†	May 82
Multiple (Marshall)	Sep 100
Rebel V Corner Horn	Aug 47
Correspondence on above	Dec 14
Small Corner Horn (Klipsch)	Jul 72
RCA LC-1A and SL-12†	Feb 81
Villichur System (Krech)	Jul 86
<b>Microphones</b>	
Electro-Voice Slimair 636	Jul 80
Mounting Home (TTO)	Sep 152
Panel Mounting (TTO)	Aug 114
Miracord XM 110 Turntable†	Dec 52
Mixer Equalizer, 3-Channel* Augspurger	Nov 87
Modulator, Transistor-Varistor* (Taylor)	Mar 62
<b>Musical Instruments</b>	
Piano, New Electronic (Miesner)	Feb 64
Correction to above	Apr 12
Wurlitzer Electronic Organ (Dorf)	
Part II—Tone coloring, vibrato circuit	Jan 128
PA System, PPA Portable (Reed)	May 77
Phono Motor, A.C.-D.C. (TTO)	Jun 114
<b>Pre-amplifiers</b>	
Fisher Phono†	May 64
Mixer (REC)	Apr 116
National Horizon 5†	Nov 106
Pentron HFP-1†	Nov 104
Pilotrol PA-913†	Dec 50
<b>Record Players</b>	
Auto	Nov 57
Junior* (Chalfin)	Mar 42
Miracord XA 100†	Dec 52
Records Review (Monitor) Jan, 126; Feb, 82; Mar, 72; Apr, 40; May, 68; Jun, 41; Jul, 84; Aug, 48; Sep, 88; Oct, 79; Nov, 114; Dec, 53	
Recording Cattle Behavior†	Nov 57
<b>Servicing</b>	
High-Fidelity Equipment (Marshall)	
Part XI—AM and FM tuner distortion: de-emphasis, pre-emphasis; noise	Jan 115
Sound Selling (Riddle)	Dec 44
Soundorama (RM)	Jan 6
Squelch (REC)	Apr 119
Squitch (Pat)	Aug 112
Switching (REC)	Mar 55
Tape Erasure, Magnetic (Gnessin)	Mar 86
Tape Playback, Wide-Range (Pat)	Jan 162
Tapes, Testing Recording (TTO)	Dec 140
<b>Tape Recorders</b>	
Adding (DiElsi)	Dec 46
Ampex 600†	Jan 119
Improving Inexpensive (Burstein)	
Part I—Preliminary survey	Apr 33
Part II—Bulk eraser; improving frequency response	May 78
Correspondence on above	Sep 14
Midgetape Model BR-1†	Jun 37
Correction to above	Sep 161
New Developments in (Heller)	Jun 36
Pentron PMD-1†	Apr 33
Switch (REC)	Jan 167
Tape-Recording Glossary	Jul 90
<b>Test Equipment (See Test Equipment)</b>	
<b>Tone Arms</b>	
Constant-Tracking (Trans-Linear)	Feb 90
Gray Viscous-Damped†	Oct 66
Tremolo Where You Want It* (Jaski)	Dec 47
<b>Tuners</b>	
Altec 303 Ct	Apr 39
National Criterion AM-FM†	Sep 84
Hallcrafters SX-62, as Tuner	Jul 78
Tweeter, Electrostatic (Hobbs)	Feb 90
Automatic Lawn Watering Indicator* (Sandretto)	Jul 44
<b>B</b>	
Baby-Listening Intercom* (McMath)	Jul 76
Bass-Reflex TV Stand (Wheelock)	Aug 42
Beating the Service Technician (Philpott)	Mar 60
Boat Electrolysis (Robberson)	Sep 112
Build This C.R.T. Tester and Rejuvenator (Cavaseno)	Aug 74
Correction to above	Oct 158
Build This Ultra-Transistorized Meter* (Queen)	Nov 63
<b>C</b>	
Callback Scourge (Margolis)	Mar 46
Capacitor-Resistor Analyzer (Pyramid CRA-1)	Jun 72
Capacitor Testing With Ohmmeter* (Prensky)	Apr 50
Capaswitch Photo Relay* (Gottlieb)	Mar 58
Cathode-Ray Engine Analyzer (DeHuff)	Dec 34
Checking and Correcting Impedance Mismatches (Middleton)	May 92
Check the Picture Tube (Dubinsky)	Mar 49
Chromatic Probe (Middleton)	Jan 77
Circuit Features of High-Fidelity Power Amplifiers (Scott)	Aug 44
Circuit Features in Hi-Fi Power Amplifiers (Scott)	Sep 79
Correction to above	Dec 128
Coaxial Tuner in FM Receiver (Napolin)	May 43
Color Bar and White Dot Generators (Scott)	Feb 32
Color Circuitry in 19" Receiver (Scott)	Jan 37
Color Servicing (Cook and Lasswell)	Jan 53

Color TV Antenna Techniques (Kamen)	Jan 60	Check Your TV Set Annually	Jun 29	niques in (van den Bosch)	Apr 56
Color TV Circuits (Kleidon and Steinberg)		DeForest Nobel Prize Overdue	Mar 31	Thermometer, Thermistor (Haas)	Jul 47
Part VIII—Circuit-tracing experimental color TV Receiver	Jan 65	Electronic Alarms	Oct 33	Ultrasonics, Applying (Milanowski)	Aug 86
Part IX—Operation and circuitry of Lawrence strip type tube	Feb 44	Giant Electronics Industry (W. Benton Harrison)	Sep 33	Metal Locators, Two Transistorized* (Bohr)	Mar 54
Part X—Isolating defective circuits in color TV receivers	Mar 52	Status of the Electronic Industry (C. M. Odorizzi)	Jul 31	<b>Musical Instruments (See Audio)</b>	
Common-Collector Transistor Amplifiers (Turner)	Sep 37	Tec-Teleducation	Feb 31	Neon-Tube Circuits, Light-Sensitive (Braunbeck)	Jan 136
Communication on Secondary Waves (Braunbeck)	Aug 53	Television for Deaf Children (Ursula Eason)	Nov 33	Noisy Fishes (Leslie)	Sep 64
Communications Ship to Shore (Konigsberg)	Oct 50	Tollevison	May 31	Oscillator-Amplifier, Revolutionary New (Shunaman)	Jun 56
Compact Loop Antenna (Pat)	Dec 130	Transistor Progress	Aug 31	Paraboloid Detects Radio Stars, Giant (Brown)	Sep 120
Composite Video Signal (Dines)	Nov 40	Universal TV Receiver	Jan 33	Photorelay, Capaswitch* (Gottlieb)	Mar 58
Computer—How Computer Works (Mumford)	Feb 58	Electrolysis Problem (Perkinson)	Dec 62	Phototransistors and Photoelectrets (Padgett)	Feb 61
Conelrad Alarm, Failure-proof* (Schaaf)	Oct 44	<b>ELECTRONICS</b>		Power Transistors Are Here (Turner)	Aug 90
Constant-Tracking Playback Arm (Trans-Linear)	Feb 90	AIEE Goes Electronic (Shunaman)	Apr 58	Searching for Oil with (McRoberts)	Dec 37
Constructing Karlson Enclosure* (Drenner)	Oct 54	IRE Attains New Heights	Jun 54	Solar Battery, Bell (RM)	Oct 8
<b>CONSTRUCTION</b> [See individual heads; Receivers, etc. Construction articles designated with asterisk (*)]		Abstract Oscillography	Apr 59	Tape Recorder-Aids Industry, Magnetic (Cornelius)	Jun 62
Contact Potential (Manly)	Sep 41	Alarm, Transistorized Photocell* (Turner)	Dec 40	Thermistors and Their Applications (Hubelbank)	Aug 94
Control Circuit* (QB)	Dec 134	Amplifier, Light (RM)	Feb 6	Timer, Interval (REC)	Apr 118
Control Room (Koushouris)	Nov 37	Amplifiers, Light (Heller)	May 45	Transformer, New Pulse (REC)	Nov 141
Convergence—no impossible but difficult (Davis)		Battery Calculations	Jul 52	Ultrasound, Scanning With (Milanowski)	Apr 54
Part I—Rainbows and black-and-white pictures	Sep 51	Bridge, A.C. (Coleman)	Jul 40	Vacuum Gauges (Schulke)	Jun 58
Part II—Rainbow's end within reach	Oct 92	Computer Works, How (Mumford)	Feb 58	Vacuum Tubes, Strain in (DeMaria)	Apr 53
Convergence in 3-Gun C-R Tubes (Lieberman)	Jan 40	Conelrad Alarm, Failure-proof (Schaaf)	Oct 44	Electronic A.C. Bridge* (Coleman)	Jul 40
Converting 630 Receivers to Inter-carrier Operation* (Bierman)	Sep 59	Connections, Solderless (RM)	Sep 8	Electronic Indicator Aids Emulsification (Peach)	Oct 114
Correspondence on above	Nov 14	<b>Controls</b>		Electronic Load (Wherry)	Jul 84
<b>D</b>		Garage Door Opener, Induction-Operated (Friedman)	Oct 116	Electronic Vacuum Gauges (Schulke)	Jun 58
DX Tiny Tuner* (Queen)	Oct 53	Garage Door, Remote-Controlled (Scott)	May 54	Electrostatic Tweeter (Hobbs)	Feb 90
Damping Factor (Corres)	Dec 12	Perma-Power RC-101†	May 56	Emerson 14-inch Portable (Scott)	Mar 32
Dependable Gas Test (Conant)	Jun 76	Traffic Control System (Newsom)	Nov 58	Emergency Receiver* (Dresser)	Apr 98
Designing Ultra-Linear Amplifier (Miller)	Sep 92	Travel Aid for Blind (Benham)	Oct 104	Correction to above	Jun 126
Diode Wattmeter* (Ives)	Feb 38	Transistor Auto Light Control* (Bohr)	May 58	Employment in Electronics (Lane)	Jul 48
Direction Finder for Small Craft* (Robberson)	May 48	Counter, Bidirectional (REC)	Mar 132	Extend Range of Your Ohmmeter (Rogers)	Oct 42
Dual-Frequency Crystal Calibrator* (Ives)	Oct 34	Electrolysis, Boat (Robberson)	Sep 112		
<b>E</b>		Employment in (Lane)	Jul 48		
<b>EDITORIALS</b> (H. Gernsback, unless otherwise noted)		Fire Detector (RM)	Jul 8		
Atomelectronics in 1980	Apr 29	Engine Analyzer, Cathode-Ray (DeHuff)	Dec 34		
Aviation Electronics	Dec 33	Geiger Counter, Poor Man's* (McCready)	Jul 42	<b>F</b>	
		High-Voltage Supply, Novel	Feb 60	4-Input Amplifier* (Stratmoen)	Nov 87
		Hugo Gernsback Award (RM)	Aug 8	460-MC Radio (Sands)	Jun 80
		Flowmeter, Magnetic Induction (Jay)	Nov 60	<b>FM</b>	
		Indicator Aids Emulsification (Peach)	Oct 114	Hi-Fi FM for Your Car (Hastings)	Feb 106
		Inverter, D.C. to A.C. (REC)	Nov 140	Granco 610 FM Set†	May 43
		Lawn Watering Indicator, Automatic* (Sandretto)	Jul 44	Florac Minuscule FM Receiver	May 47
		Leak Detector* (QB)	Jul 102	Propagation Problems, Simple Graphical Solution for TV and FM (Rockey)	Jan 72
		Light Control, Automatic (QB)	Jun 108	Receiver, Coaxial Tuner in FM (Napoli)	May 43
		Magnecord†	Aug 52	Simple TV/FM Antenna (Loveless)	Jun 43
		Maser (New Electronic Device) RM	Mar 16	FM Wireless Intercom* (Neil)	Oct 46
		<b>Medicine</b>			
		Electroencephalography, New Tech-			



MODEL RE-1

**MULTIPHASE**  
**"Rejuva-Tube"**  
**CRT REJUVENATOR**

Brings "Dim-Outs" Back to Life  
**SENSATIONAL MONEY MAKER**

Complete Kit \$49.50 Factory Wired \$59.50

Condensed Instructions Printed Inside Case Lid  
 Write for Manual on Rejuvenation with the "Rejuva-Tube"

\*Patent Pending

## No Guesswork with Rejuva-Tube!

- Only Device That Meters Cathode Activity During Rejuvenation
- Tells Exactly When Rejuvenation Should Stop —
- Prevents Damage to Cathode Emitting Surface
- Built-in Current Limiter Eliminates Possibility Of Accidental Cathode Ribbon Burn-Outs

**COMPARE THESE FEATURES**

Tests — Repairs TV Picture Tubes Without Removing Tube From Set

- Compact, light-weight and easy to use.
- Complete Tester: detects open or shorted elements and leakage as high as 3 megohms between elements.
- Highest quality lab instrument construction.
- Special metered circuit removes "particle" shorts between heater and cathode.
- Checks cathode emission and grid cut-off characteristics.
- Predicts approximate life-expectancy of tube — identifies gassy tubes.

**DEALERS!** Now you can sell those "dim-out" trades in at a good profit, and back them up!

**SERVICEMEN!** Sell rejuvenation service. Fully 80% to 90% of picture tubes that have gone dim in service can be quickly reactivated to furnish up to years of "bright as new" service!

"Rejuva-Tube" By The Designers of **Central Electronics, Inc.**  
 1247 W. Belmont Ave. Chicago 13, Illinois

# Hit the Top in Hi-Fi Listening Pleasure

## For the first time ALL the know-how revealed for you by Audio Experts!

### Here's How You Can Master All The Tricks Of The Trade—Get True Sound Reproduction—Be An Expert!

Does your Hi-Fi system seem to be just short of what you really want—slight distortion—lost highs—muffled middle range—unsatisfactory lows—poorly balanced response? Perhaps adding just one low-priced piece of equipment would make all the difference in the world in listening thrills!

Audio Engineers and Technicians know the answers . . . know when a Hi-Fi system is out of balance . . . how to change a single component and improve the response 100% . . . how to build, repair and maintain any system . . . and do it *without spending hundreds of unnecessary dollars*. The only difference between you and these experts is knowledge! And now, *for the first time*, a publisher has gathered together in easy-to-read book form *all* the information these experts possess!

#### THE GERNSBACK AUDIO AND HIGH-FIDELITY LIBRARY . . .

brings the top men in the Audio field right into your home or shop . . . men who can tell you just what's right or wrong with any Hi-Fi system . . . men who can give you all the inside tips on tape recording—turntables—pickups—amplifiers—speakers—enclosures. Now you will know how audio circuits work, how to use them properly—how to tell which parts work best in which systems. At last you will have complete diagrams—the latest tips, the inside dope—in 9 handsomely bound books. You will have at YOUR fingertips the **FIRST** and **ONLY COMPLETE** library of practical, detailed Audio and Hi-Fi know-how ever published!

#### THE FIRST BOOK IS READY NOW!

**BASIC AUDIO COURSE**, by Donald Carl Hoefler the well-known RCA recording engineer, gives you all the lowdown on what audio systems must do—covers such vital subjects as: audio frequency amplifiers, principles of audio amplifier design, push-pull amplification, inverse feedback, volume compression, rectification, filtering. This important basic book tells you about the Forms of Sound, the Characteristics of Music, the Physics of Music and so much more it's impossible to list all the topics.

#### AND YOU CAN SAVE 25%

You may have any or all of the nine books at the low retail price of \$5.00 each. OR you may become a member of the GERNSBACK AUDIO AND HIGH-FIDELITY LIBRARY PLAN and SAVE 25%.

#### Here Is How the Library Plan Works

- 1) You may examine each new book IN YOUR OWN HOME FOR 10 FULL DAYS AT OUR RISK. If you don't like it, return it.
- 2) You only have to take four of the nine Hi-Fi books to get each one at the special low member's price of only \$3.75 per copy—you can save \$11.25 on the whole library!
- 3) You will receive the very latest book every three months as it comes off the press. Among the additional titles you will get are: High Quality Audio; Maintaining

#### NO-RISK COUPON

GERNSBACK PUBLICATIONS, INC.  
Dept. 12-55, 25 West Broadway, New York 7, N. Y.

- Send me postpaid the deluxe, hard-cover edition of BASIC AUDIO COURSE. \$5.00 is enclosed.
- Enroll me now as a member of the GERNSBACK AUDIO AND HIGH-FIDELITY LIBRARY. Send me postpaid the deluxe, hard cover edition of BASIC AUDIO COURSE. If satisfied I agree to remit the special member's price of \$3.75 and will take at least 4 books.
- I want to know more about the GERNSBACK AUDIO AND HIGH FIDELITY LIBRARY. Send full information.

NAME .....  
Please Print

STREET .....

CITY..... STATE.....

High Fidelity; The Golden Ear; Audio Hints; Constructing Audio Amplifiers; The Audio Data Book; Loudspeakers And Speaker Systems; Loudspeaker Enclosures.

#### Fill Out This No-Risk Coupon Today!

All you have to do is fill out this coupon and mail it today. Just check the box next to the plan that suits you best. Don't delay! Get your copy of BASIC AUDIO COURSE for a FREE home examination now!

#### ANNUAL INDEX

(Continued)

Failure-Proof Conelrad Alarm* (Schaaf)	Oct	44
<b>FICTION</b>		
SilentSound (Fips)	Apr	36
Correspondence on above	Jun	14
Teleductor (Gernsback)	Feb	54
Flexible Radio Control System* (Dorf)		
Part I	Aug	60
Part II	Sep	38
Foldover (Mandl)	Mar	38
<b>G</b>		
Garage Door Opener, Induction-Operated (Friedman)	Oct	116
Garage Door, Remote-Controlled (Scott)	May	54
Gated Beam Discriminator (Heller and Shulman)	Nov	50
Geiger Counters, Poor Man's (McCready)	Jul	42
Giant Paraboloid Detects Radio Stars (Brown)	Sep	120
Gilding Golden Ears* (Marshall)	Feb	91
Correction to above	Apr	120
<b>H</b>		
High-Fidelity Dictionary (Bukstein)	Feb, 70; Mar, 76; Apr, 43; May, 87; Jun, 38; Jul, 90	
Hi-Fi FM for Your Car (Hastings)	Feb	106
High-Power Williamson Amplifier for Hi Fi* (Haffer)	Dec	42
High Power With Small Speakers (Matsinger)	Nov	98
High-Voltage Supply	Feb	60
Home-Built Grid Dip Meter* (Dresser)	Aug	79
Horn Antenna Construction (O'Leary)	Apr	62
Correspondence on above	Aug	14
Horn Type Speaker System (Augsburger)		
Part I—Fundamentals of horn speakers	Apr	30
Part II—Variations in Klipsch design, exponential labyrinth, radial horn	May	82
How Computer Works (Mumford)	Feb	58
How Matrix Works (Middleton)	Aug	32
How Much Will a Resistor Take? (Manly)	Jul	56
Correction to above	Sep	156
<b>I</b>		
Improved Transistor Regenerator* (Amorose)	Nov	52
Improving Low-Priced Tape Recorders (Burststein)		
Part I—Preliminary Survey	Apr	33
Part II—Bulk eraser; improving frequency response	May	78
Correspondence on above	Sep	14
Improvement in AM-FM Tuners (Stoner)	Nov	53
Individual TV Set Trouble Record (Ahemann)	Apr	80
Induction-Operated Garage Door Opener* (Friedman)	Oct	116
Intercarrier Buzz (Middleton)	Apr	60
Intercoms (See Audio)		
Intruder Alarm (Pat)	Dec	129
It's Reactance That Counts (Manly)	Dec	59
<b>J</b>		
Joe Doaks—TV Repairman (Farad)	Jan	50
Junior Record Player-Amplifier* (Chalfin)	Mar	42
<b>L</b>		
Laboratory Type Tube Tester* (Dewar)	Apr	47
L'Antenne Gernsback	Jun	97
Leave 'Em In or Take 'Em Out (Darr)	Nov	45
Light-Sensitive Neon-Tube Circuits (Braunbeck)	Jan	136
Low-Frequency Compensation in Video Amplifiers (Sodaro)	Jun	52
Low-Frequency Sweep Generator Adapter* (Graham)	Jan	99
<b>M</b>		
Machines Make TV Sets	Jan	71
Making Photoetched Circuits in your Workshop* Part I (Dorf)	Dec	56
Making Printed Circuits Is Easy (Jaski)	Sep	34
Magnetic Induction Flowmeter (Jay)	Nov	60
Magnetic Tape Erasure (Gnessin)	Mar	86
Magnetic Tape Recorder Adds Industry (Cornelius)	Jun	62
Metal Locators, Two Transistorized* (Bohr)	Mar	54
<b>METERS (See Test Equipment)</b>		
Meter Resistance Measurement (Ives)	May	100
Midget TV Kilovoltmeter (McCready)	Dec	79
Midget Transistorized Signal Injector* (McCready)	Jun	63
Milvamp* (Frantz)	Dec	64
Miniature TV Antennas	Jan	39
Miniscule FM Receiver (Florac)	May	47
Missing Link in Speaker Operation, Part II (Tomcik)	Jan	106
Mobile Radio Shop (Holman)	Mar	59
More on Matrix (Middleton)	Sep	53
Multiple Speakers for High-Fidelity (Marshall)	Sep	100
<b>N</b>		
New British Keyed A.G.C. Circuits	Jan	70
New Chromatic Amplifier (Middleton)	Feb	40
New Departure in TV Antennas (Kamen)	May	34
New Developments in Tape Recorders (Heller)	Jun	36
Correction to above	Sep	161
New Electronic Piano (Miessner)	Feb	64
New Loudspeaker Enclosure* (Coates)	Jun	30
New Multimeters and V.T.V.M.'s (Scott)	Aug	68



ANNUAL INDEX (Continued)

New Picture-Tube Testers (Scott)	Jul	37
New Simpson Portable Field-Strength Meter (Middleton)	Jul	35
New Techniques in Color Demodulation (Cook)	May	32
New Techniques in Electroencephalography (van den Bosch)	Apr	56
New Test for Capacitor Leakage (Middleton)	Sep	44
Noisy Fishes (Leslie)	Sep	64
O		
1000 and 100 Cycle Filter* (Fred)	Dec	86
Orient Your TV Antenna with a V.T.V.M. (Bourget)	Dec	114
P		
PPA-700 Portable PA System (Reed)	May	77
Perk Up the Little Set (Lemons)	Jun	77
Phono Oscillator plus Signal-Tracing Amplifier* (Lederer)	May	96
Phototransistors and Photoelectrets (Padgett)	Feb	61
Pictorial Technical Reports		
What's New	Nov, 54;	Dec 54
Picture-Tube Replacement Guide (Scott)	Jan	48
Pistol-Grip Signal Tracer* (Davidson)	Feb	36
Planets and TV DX (Nelson)	May	36
Poor Man's Geiger Counter* (McCready)	Jul	42
Portable Has Transistor Output (Leslie)	Jul	51
Post-Acceleration Tube (Shunaman)	Dec	90
Power Transistors Are Here (Turner)	Aug	90
Practical Transistor Tests (Padgett)	Jul	32
Printed-Circuit TV Chassis	Jan	64
Probes for Profit (Sherman)	Mar	96
Protect Your Transistors (Reed)	Feb	104
R		
R.C. Controlled Oscillator* (Straede)	Dec	80
RADIO		
Beads, Ferrite, for Feedback Suppression	Nov	56
Amplifiers, Common-Collector Transistor (Turner)	Sep	37
Circuitry, A. C. Supply (Hedge)	Oct	49
Circuits, Photoetched* (Dorf)	Dec	56
Communication on Secondary Waves (Braunbeck)	Aug	53
Communication Ship to Shore (Konigsberg)	Oct	50
Contact Potential (Manly)	Sep	41
Control System, Flexible* (Dorf)	Aug	60
Part I	Sep	38
Part II	Sep	38
Direction Finder, for Small Craft* (Robberson)	May	48
Electrolysis Problem (Perkinson)	Dec	62
Gated-Beam Discriminator (Heller and Shulman)	Nov	50
Frequency Converter, Transistor (Pat)	Nov	134
Intercoms		
Adapting the A.C.-D.C. (Receiver)* (Guarente)	Nov	48
FM Wireless* (Neil)	Oct	46
Mobile		
460 MC (Sands)	Jun	80
Radio Shop (Holman)	Mar	55
Printed Circuits Is Easy, Making (Jaski)	Sep	34
Receivers, Tuners		
DX Tiny Tuner* (Queen)	Oct	53
Emergency* (Dresser)	Apr	98
Correction to above	Jun	126
FM for Your Car, Hi-Fi (Hastings)	Feb	106
Interflex, Transistorized* (Grace)	Aug	54
Portable, Has Transistor Output (Leslie)	Jul	51
Transistor, Regenerator, Improved* (Amorose)	Nov	52
Transistor, Uses No Power Supply* (Grace)	Apr	96
Tube and Transistor* (Gottlieb)	Sep	42
Tuner, for All-Wave Set (QB)	Jan	168
Tuner, One-Tube FM (REC)	Apr	116
TV Sound in Your Car* (Morrisette)	May	52
Resistor Take?, How Much Will a (Manly)	Jul	56
Correction to above	Sep	156
Resistor Ratings (Corres)	Nov	10
Service Problems With Straightedge, Solving (Manly)	Aug	56
Servicing Light Plane Radios (Holahan)	Jul	53
Shortwave Conversion* (TTO)	Dec	140
Squelch, Novel (REC)	Jul	99
Superregenerative Amplifier-Detector (REC)	May	130
Transistor D.C. Transformer, Build* (Queen)	Dec	61
Vocaltrol	Aug	50
Voltbox, A.C.* (Turner)	Sep	43
Waveguides, Long-Distance (RM)	Apr	10
Wireless Wireless, Really (Hallows)	Aug	58
Rainbow Generator (Starks)	Jan	79
Rainbow Patterns With Conventional Generators (Middleton)	Dec	96
Re: Linearity Generator	May	98
Really Wireless Wireless (Hallows)	Aug	58
Remote Transistor Amplifiers* (Noll)	Dec	45
Revolutionary New Oscillator-Amplifier (Shunaman)	Jun	56
Rotatable Loop Antenna for Broadcast Reception (Dewar)	Feb	100

A Revolutionary New Way To Learn **ELECTRONICS** By Doing!

# BUILD 14 RADIO & ELECTRONICS CIRCUITS AT HOME



**NO TOOLS  
NO SOLDER  
Experience  
Unnecessary**



**BUILD WORKING  
RADIOS IN  
10  
MINUTES!**

from  
radio  
to man

**\$19.95**

Model T-200  
(less batteries)

**PERFECT GIFT**

EREK-TRONICS Kit is a revolutionary way to grasp the theory of radio & electronics. Permits doing and seeing without handicap of construction and soldering. No tools, no heat needed. So clear and safe, anyone interested can easily build its 14 circuits (including code practice unit & transmitter). Immediate results build great interest, and the clear, step-by-step method exposes the bare, basic principles of electronics for faster learning.

**FOR CAREER OR HOBBY**

Not a toy. Not a dead-end kit, but made so its additional parts may be added to expand its value, leading to ever-widening circles of electronics learning. This new, APPROVED educational procedure starts anyone into the great field of electronics, as a career or as a hobby. We guarantee the EREK-TRONICS KIT to give, in a very short time, a real working knowledge of radio & electronics.

**EDUCATIONAL**

**FUNDAMENTAL BASIS FOR RADIO, TELEVISION, HI FI**

EREK-TRONICS Kit clearly, simply, trains anyone, 8 to 80, in these principles: Radio-Electronics Theory, Construction Practice, Reception, Transmitting, Audio Amplification, trouble shooting. You learn Electronic Symbols, Set Diagrams, how to build 14 different circuits. You learn service and trouble shooting through the method of Signal Tracing. You get code and basic FCC Novice License training. Throughout, the feeling of immediate accomplishment keeps interest high, encourages exploration. In short, EREK-TRONICS Kit Training gives a sound working, practical knowledge of modern electronics—the basis of RADIO, TV, Hi Fidelity.

**Model T-200-B Incl. batt. 22.95**

EREK-TRONICS Kit requires no instructor. Everything plugs in, or "Jiffy Clips" in place on Electronics "Road Map" (template). So successful. THIS KIT HAS THE MUSEUM of Science Approval. PATENTED JIFFY CLIP METHOD IN USE BY: Cal. Tech., Colgate, Columbia, Harvard, M.I.T., Notre Dame, Stanford —other colleges.

**COMPLETE • GUARANTEED**

EREK-TRONICS Kit contains every needed component 14 templates, variable condensers, resistors, code key, mounting board, ear phone, etc. Order with this Guarantee: Build a working radio in 10 minutes... be ABSOLUTELY DELIGHTED or money back. Order by mail today & receive these FREE EXTRAS: FCC Frequency Spectrum Chart in full color, and "Hi Fi From A To Z".

**Order by mail now.**

**WHOLESALE RADIO PARTS CO., INC.**

**311 W. BALTIMORE ST. • BALTIMORE, MD.**

## GARAGE DOOR REMOTE CONTROL

Actuator Mechanism \$24.50

Write for information  
**P. E. HAWKINS CO.**  
631 PROSPECT KANSAS CITY 24, MO.

## LEARN PRINTED CIRCUITS

Get Your Free Literature Now.  
**WRITE TODAY.** Dept. 12R.

**TELE-DIAGNOSIS**

155 W. 72ND ST. N.Y. 23, N.Y.

## See What's New in ELECTRONICS

Radio • TV • High Fidelity



FREE!

**Send for  
NEWARK'S 1956 CATALOG**

See the latest and finest equipment ever offered in High-Fidelity, Radio, TV, Amateur and Electronics. Select the fast, dependable way, from this new 260-page catalog.

NEWARK

ELECTRIC COMPANY

Dept. RE-12, 223 W. Madison, Chicago 6, Ill.

WEST COAST BRANCH  
4736 W. Century Blvd., Inglewood, Calif.

Watch for January Special  
TV Issue of  
**Radio-Electronics**

## GET THIS BOOK AND BUILD!

**METAL LOCATORS  
TIMERS  
RECEIVERS  
GEIGER  
COUNTERS**

using

**RAYTHEON  
CK722  
TRANSISTORS**

All you need to know  
is in this new

only  
50¢

RAYTHEON TRANSISTOR  
APPLICATIONS BOOK

More than 50 useful, easy-to-make types of transistorized equipment. 116 pages — contains complete wiring diagrams, illustrations, parts lists and procedure information. Limited supply! — AVAILABLE AT THE...



## Almo RADIO CO.

**509 ARCH ST., DOWNTOWN PHILA.**

6205 MARKET ST. WEST PHILA.  
7540 FRANKFORD AVE. NORTH EAST PHILA.  
1133-37 HADDON AVE., CAMDEN, N. J.  
4401 VENTNOR AVE., ATLANTIC CITY, N. J.  
550 MARKLEY ST., NORRISTOWN, PA.  
1122 FRENCH ST., WILMINGTON, DEL.  
317 PARK HEIGHTS AVE., SALISBURY, MD.



Traveler 63R50-A, Jan 158	TV-DX April-June	Apr 72	Stations		
Westinghouse 600T16, Feb 133; V-2342, V-2343, Sep 145	TV-DX July-Sept	Jul 71	As of Nov 15, 1954	Jan 76	
Zenith G510, Feb 133, 20J22, Jan 159; M2230R, Dec 139	TV-DX Oct-Dec	Oct 103	(Supplements: Feb, 6; Mar, 8; May, 6)		
Ted Tackles Tough TV Problems (Waner) Feb 50	Planets and TV (Nelson)	May 36	As of April 18, 1955	Jun 45	
<b>TELEVISION</b>	Foldover (Mandl)	Mar 38	(Supplements: Jul, 6; Aug, 8;		
<b>Amplifiers</b>	Intermittents, Those Deadly (Margolis)	Dec 98	Sep, 8; Oct, 8; Nov, 8; Dec, 8)		
Video, Low-Frequency Compensation in (Sodaro)	Machines Make TV Sets	Jan 71	<b>Theory</b>		
and Electronics—Look into Future (Sarnoff)	Phono Jack for TV Sets	May 138	Television—It's a Cinch (Aisberg)		
<b>Antennas</b>	Propagation Problems, Simple Graphical for TV and FM (Rockey)	Jan 72	14th Conversation, 2d half—Down with Capacitors! Direct coupling, useful diode	Jan 68	
Beams TV Signals 188 miles	<b>Receivers</b>		15th Convers., 1st part—Separating sync signal; diode, pentode separators	Feb 47	
Cartridge-Tuned U.H.F.—V.H.F. (Vidonaire)	Printed-Circuit TV Chassis	Jan 64	15th Convers., 2d part—Pentode separators; d.c. level problems; differentiator, integrator circuits	Mar 41	
Frost-proof Mast (TTO)	R.F. Amplifier Stage in TV Receiver (Clinic)	Oct 96	15th convers., 3d part—Differentiation, integration in action; effect of time constant	Apr 78	
L'Antenne Gernsback	Series-String Tubes in New TV Sets	Aug 34	16th convers., 1st half—Voltage supplies	May 38	
Horn Construction (O'Leary)	Stagger-Tuned I.F.'s (REC)	Aug 34	16th convers., 2d half—R.f. high-voltage supplies; vice becomes virtue	Jun 48	
Correspondence on above	Transistorized Portable (Herzog & Lohman)	Jan 43	17th convers., 1st half—Capturing TV signals, half-wave antenna, problem of passband, lead-in	Jul 60	
Miniature	Reception in Isolated Areas, Top TV. (Noll)	Jan 58	17th convers., 2d half—Impedances, reflections; fantastic variety of antennas, reflectors, directors	Aug 36	
New Departure	Recording (Pat)	Feb 131	18th convers., 1st half—Trichromatic principle; transmission problems, simultaneous or sequential—saving fine detail, how to carry color inside 6-mc band	Sep 56	
Orient Your (Bourget)	<b>Schematics</b>		18th convers., 2d half—color tube	Oct 88	
Simple TV/FM (Loveless)	Emerson 14-inch Portable (Scott)	Mar 32	Those Deadly Intermittents (Margolis)	Dec 98	
Techniques in Color (Kamen)	Motorola Frame-Lock Circuit†	Nov 56	Tube, Flat (RM)	Mar 10	
U.H.F. Installation Techniques (Davis)	Motorola TS-902†	Jan 37	Tube, Post Acceleration (Shunaman)	Dec 90	
Wide-Band TV (Pat)	RCA Model 21-S-500R†	Aug 34	Tuner, Standard Coil Model TV-2232†	Jul 59	
Yagi Antenna Query (QB)	<b>Servicing</b>		<b>U.H.F.</b>		
Atom-Bomb Effect (McRoberts)	Alignment (Buscombe)	Dec 102	Alignment (Middleton)	Mar 44	
Boosted High Voltage (REC)	Arcing and Corona (Clinic)	Jan 75	Converter†	Mar 45	
<b>Circuitry</b>	Audio Techniques in (Clinic)	May 41	Installation Techniques (Davis)	Feb 52	
I-Tube Deflection Circuit (REC)	Barkhausen Oscillations, Elimination of (Clinic)	Jan 75	What's Happening to (Lachenbruch)	Jan 34	
Correspondence on above	Blooming (Clinic)	Jan 74	Underwater (Hallows)	Jan 62	
A.G.C., New British Keyed	Callback, Scourge (Margolis)	Mar 46	Underwater (RM)	Jan 6	
Converting 630 Receivers to Intercarrier Operation* (Bierman)	Check the Picture Tube (Dubinsky)	Mar 49	What! No High Voltage?	Mar 36	
Correction to above	Color (Cook and Lasswell)	Jan 53	Television and Electronics—Look into Future (Sarnoff)	Jan 46	
Synchroguide Circuit (Gunny)	Gated Sync Separator (Clinic)	Mar 50	Television Bar Generator Modifications	Jul 39	
Closed Circuit TV (RM)	Generators, Rainbow Pattern with Conventional (Middleton)	Dec 96	Drift (Prosser)	Jan 62	
<b>Color</b>	High-Voltage Rectifier (Clinic)	Jan 74	Television Underwater (Hallows)	Jan 62	
Antenna Techniques (Kamen)	Horizontal A.F.C. Systems, Trouble-shooting (Glickstein)	Oct 82	<b>TEST EQUIPMENT</b>		
Circuitry in 19" Receiver (Scott)	Individual TV Set Trouble Record (Ahneemann)	Apr 80	Alignment Aid (REC)	Mar 132	
TV Circuits (Kleidon and Steinberg)	Insurance That Counts (Hallows)	Dec 88	Amplifier, New Chromatic (Middleton)	Feb 40	
Part VIII—Circuit-tracing experimental color TV receiver	Intercarrier Buzz (Middleton)	Apr 60	Audio Analyzer, Heathkit Model AA-1†	Sep 87	
Part IX—Operation and circuitry of Lawrence strip type tube	Ion Spot Prevention (Clinic)	Apr 64	Bar Generator Modifications Reduce Drift (Prosser)	Jul 39	
Part X—Isolating defective circuits in color TV receivers	Ion-Trap Indicator (TTO)	Jan 165	Audio Generator, Your Receiver as (Lingel)	Dec 63	
Convergence in 3-Gun C-R Tubes (Lieberman)	Ion-Trap Magnets, Testing (McRoberts & McCready)	Apr 84	Bar Generator and Sweep Adapter* (Morrisette)	Jun 65	
Convergence Not Impossible but Difficult (Davis)	Joe Doaks—TV Repairman (Farad)	Jan 50	Bridge, Electronic A.C.* (Coleman)	Jul 40	
Part I—Rainbows and black-and-white pictures	Kilovoltmeter, Midget* (McCready)	Dec 79	Bridge, Wide-Range Transistorized* (Queen)	Mar 106	
Part II—Rainbow's end within reach	Little Things That Count (Margolis)	Nov 36	Capacitor Leakage, New Test for (Middleton)	Sep 44	
Demodulation, New Techniques in (Cook)	Picture Smear (Glickstein)	Apr 90	Capacitor-Resistor Analyzer	Jun 72	
for Medical Use (RM)	Picture-Tube Replacement Guide (Scott)	Jan 48	Capacitor Testing (Prensky)	Apr 50	
Matrix Works, How (Middleton)	Retrace Blanking (Clinic)	Jan 48	Color Bar and White Dot Generators (Scott)	Feb 32	
Matrix, More on (Middleton)	Retrace Elimination Circuits (Clinic)	Sep 62			
Matrix, Again the (Middleton)	R's and C's, Watch Your (Matsinger)	Aug 40			
New System (RM)	Snow Elimination (Clinic)	Dec 94			
Servicing (Cook and Lasswell)	Sound Bars (Clinic)	Jun 50			
Tape Recorded (RM)	Sync Pulses†	Nov 42			
What's the Dope on	Sync Separation, Diode and Triode Clippers (Clinic)	Jul 68			
Community Systems (RM)	Ted Tackles Tough TV Problems (Waner)	Feb 56			
Composite Video Signal (Dines)	Traps (Clinic)	Feb 50			
Control Room (Koushouris)	U.H.F. Alignment (Middleton)	Dec 109			
<b>DX</b>	U.H.F. Converter†	Mar 44			
1954 (Tilton)	Video Detector, Troubleshooting the (McRoberts)	Mar 45			
TV-DX January-March	TV Signal Circuit Feedback (Middleton)	Dec 106			
	Signal Marks Response Curve (Scala)	Jun 46			
		Jul 58			

# The MASTER SETS YOU UP!

here's what's in it for you . . .

### DOLLAR-WISE PURCHASING

Shop before you buy! Do it right at your own bench through the supermarket pages of the industry-wide MASTER. Compare specs and prices first—then buy and save

**A GOLD MINE OF FACTS** All the latest info on new products—new models—changes in specs. You name it and it's in the MASTER catalog file of the electronic parts industry

- 100,000 items • Complete descriptions
- Specifications—Prices • 11,000 illustrations • 350 mfrs • 8 x 11", 6 lbs.

List \$7.50  
As low as

**\$2.95**

from parts distributors

**UNITED CATALOG PUBLISHERS, INC.**  
110 Lafayette St., New York 13



## 1956 edition

FULLY CATALOGS

TUBES — TRANSMITTERS

TEST EQUIPMENT — COMMUNICATION

ANTENNAS — RESISTORS — COILS

RECEIVERS — TRANSFORMERS

RECORDING & PA SYSTEMS

CAPACITORS — HARDWARE

RELAYS — TOOLS, ETC

**1456 pages**

**OFFICIAL BUYING GUIDE OF THE INDUSTRY**

UNTIL DEC. 25th ONLY



LEKTRON SPECIALTIES



PLAYS SANTA CLAUS DOUBLE BONUS OFFER

ON EVERY ORDER OF \$10 OR MORE! BONUS No. 1 BONUS No. 2 BOTH FREE WITH EACH \$10 ORDER!

FREE, Useful Xmas Gift With Every Order! GUARANTEED SATISFACTION!

- Thousands of "KIT KING" kits sold—not ONE returned! 65 TUBULAR CONDENSERS, 25 values; 1000 PCS. SPAGHETTI, NEW KIT! Precut for shop use; Leaking to 4"; 80 CARBON RESISTORS, Imagined! 35 values; 30 BATHTUB & TUBULAR OILS, Outstanding variety; 50 RES. COILS & CHOKES, Shop-ass'd; 50 TUBE SHIELDS; 30 VARIABLE CONDENSERS, Up to 300 mmf; 18 ROTARY SWITCHES, Secon's! Single & dual gauges; 60 MICA CONDENSERS, Rare type; 61 CERAMIC CONDENSERS, Tubular, button disc types; 10 PANEL LITE ASSEMBLIES, Ass'd. colored levels; 25 INSTRUMENT KNOBS, Ass'd. bakelite round, knurled, pointer, skirted; 13 PC. TWIST DRILL KIT, Rare value!

ANNUAL INDEX

(Continued)

Table listing articles with columns for title, date, and page number. Includes entries like Transistor Radio Uses No Power Supply\*, U.H.F. Alignment (Middleton), Variable Damping—How Good Is It?, Watch Your R's and C's (Matsinger), etc.

KEY TO SYMBOLS AND ABBREVIATIONS \* Construction Articles † Section of full-length article Clinic Television Clinic Pat Patents QB Question Box REC Radio-Electronic Circuits RM Radio Month TFO Try This One Items marked as above appeared monthly. Regular departments not indexed are Business, Technician's News, New Devices, People, Technical Literature, Book Reviews. In most entries author's name is included.



HOW TO ORDER Check items wanted. Return entire ad with check or M.O. Incl. sufficient postage; excess returned. COD orders 25% down. Rated, net 30.

LEKTRON SPECIALTIES 28 GARDNER STREET, CHELSEA 50, MASS.

Form for ordering with fields for NAME, STREET, CITY, ZONE, STATE, and checkboxes for enclosed sales, merchandise, postage, and ship COD.

# technical Literature

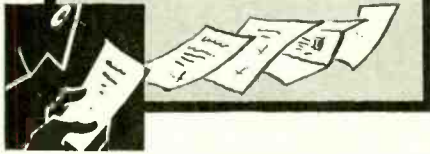

## RECEIVING TUBES

RCA's 20-page booklet *Receiving Type Tubes for Industry and Communication* contains tabular data, tube base diagrams and photographs of special red tubes, premium tubes, pencil tubes and other types for u.h.f. applications; computer tubes, glow-discharge tubes, small thyratrons, low-microphonic amplifier tubes, etc.

Commercial Engineering Department, RCA Tube Div., Harrison, N. J., 20c.

Any or all of these catalogs, bulletins, or periodicals are available to you on request direct to the manufacturers, whose addresses are listed at the end of each item. Use your letterhead—do not use postcards. To facilitate identification, mention the issue and page of RADIO-ELECTRONICS on which the item appears. UNLESS OTHERWISE STATED, ALL ITEMS ARE GRATIS. ALL LITERATURE OFFERS ARE VOID AFTER SIX MONTHS.

## MASTER TV MANUAL

Blonder-Tongue's 12-page *Master TV Installation Manual* discusses all types of multiple TV systems, industrial TV systems and the proper use of *Masterline* equipment. Illustrated sections cover antenna and line installations, signal distribution, closed-circuit TV, system maintenance and troubleshooting procedures. Simplified charts and tables, with specific examples, show how to calculate signal levels at any point. Amplifiers, converters, tapoffs and accessories are also described.

Blonder-Tongue Labs., Inc., 526-536 North Ave., Westfield, N. J.

## ELECTRONIC PROJECTS

A 16-page *Catalog No. 4* lists 80 projects for the electronic experimenter, service technician, engineer, etc. Twenty-one categories include timers, organs, relays, model controls, amplifiers, power supplies, broadcast radio, remote controls, transceivers, musical instruments, laboratory apparatus and other items. Complete circuitry, parts list and explanatory notes are given for each of them.

Henry Francis Parks Laboratory, 104 S. E. 57th Ave., Portland 15, Ore.

## RADIO AND TV FACTBOOK

RETMA's *Fact Book—Radio-Television Electronics Industry* is a compilation of available statistics on the production and sale of radios and TV receivers; data on manufacturers' sales of receiving and picture tubes, etc. and, to the extent that such material is available, a detailed statistical analysis of the size and composition of the

# NOW—understand AUDIO—HIGH FIDELITY from preamplifier to speaker!

Whether you're on your first simplified hi-fi system, or working on complex custom jobs, this brand new book by RCA recording engineer Donald C. Hoefler will give you a firmer grasp of the principles of audio and help you approach ultimate realism in sound reproduction. Covers everything in precise detail from the nature of sound, through an analysis of every audio unit, to techniques of sound recording. Required reading for anyone interested in audio as a profession—or a hobby.

## JUST A FEW OF THE TOPICS COVERED

Nature and forms of sound • Music • Hearing • The orchestra • Logarithmic units of measurement • The decibel • Measuring instruments • Classes of audio amplifiers • Push-pull • Phase inversion • Power supplies • Voltage regulation • Distortion and noise • Insertion loss • Attenuators • Mixers • Equalizers • Loudspeaker systems • Speaker enclosures • Horn design • Multiple speakers • Types and selection of microphones • Disc recording • Drive mechanism • Tracking error • Styli • Tape recording • Erasing • Magnetization

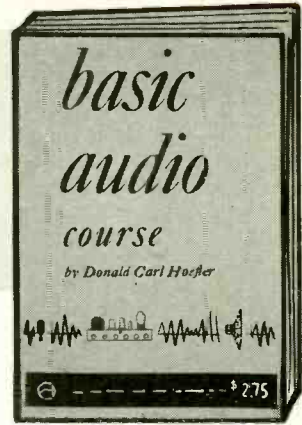

By Donald C. Hoefler. No. 66 Paper cover 224 pgs. 175 illus. \$2.75. Hard cover \$5.00.

## COMPANION GERNSBACK LIBRARY BOOKS

High-Fidelity Techniques. No. 42.....\$1.00  
High-Fidelity—Design, Construction, Measurements. No. 48..... 1.50  
Practical Disc Recording No. 39..... .75  
Public-Address Guide No. 41..... .75  
Basic Radio Course No. 44..... 2.25  
Transistors—Theory and Practice No. 51..... 2.00

See your distributor—or mail this coupon

GERNSBACK LIBRARY, INC., Dept. 125  
25 West Broadway  
New York 7, N. Y.

My remittance of \$..... is enclosed. Please send me the following books postpaid.  
No. 66—Basic Audio Course  
 Hard cover \$5.00  Paper Cover \$2.75  
 39  41  42  44  48  51

Name.....  
(Please print clearly)

Street.....

City..... State.....

# don't let it get you down!

let the MASTER save you... see pg. 155



## ELECTRONICS ENGINEERING DEGREE IN 27 MONTHS

Prepare for unlimited opportunities of the Electronic Age! Earn your B.S. degree in 27 months at Indiana Technical College. Intensive, specialized course. Comprehensive training in math and electrical engineering, advanced radio theory and design, television, electronics, Modern laboratories. Low rate. Also B.S. DEGREE IN 27 MONTHS in Aeronautical, Chemical, Civil, Electrical and Mechanical Engineering. G.I. approved. Enter December, March, June, September. Earn part of your expenses in Fort Wayne while studying. Write for catalog.

INDIANA TECHNICAL COLLEGE  
1712 E. Washington Blvd., Fort Wayne 2, Ind.  
Please send me free information on B.S. ENGINEERING DEGREE IN 27 MONTHS as checked.  
 Electronics  Chemical  Aeronautical  
 Civil  Mechanical  Electrical  
Name.....  
Address.....

## WRITE FOR THIS



## DEALER SALES KIT MAKE BIG HI-FI PROFITS

Sell the finest HI-FI Units for custom building or in BEAUTIFUL CABINETS... Sell BELOW REGULAR WHOLESALE PRICES with full dealer mark-up and with price protection.

TRANSVISION Hi-Fi Equipment is SOLD THRU SELECTED DISTRIBUTORS

TRANSVISION, INC., NEW ROCHELLE, N. Y.  
In Canada: 1338 Queen St. W., Toronto 3, Ont.

TRANSVISION, INC., New Rochelle, N. Y. RE-12  
Rush FREE Dealer SALES KIT on HIFI and name of nearest distributor.  
Name.....  
Address.....  
City..... State.....



**a HIT in**  
**High Fidelity**  
**with**  
**COLLINS**  
**AUDIO PRODUCTS CO.**  
**'PRE-FAB' TUNERS**

Collins Audio Products Co. is in no way affiliated with Collins Radio Co.  
 Each Collins Tuner Kit is complete with punched chassis, tubes, power transformer, power supply, components, hardware, dial assembly, tuning eye, knobs, wire, etc., as well as the completed sub-assemblies: FM tuning units, AM tuning units, IF amplifiers, etc. All sub-assemblies wired, tested and aligned at the factory make Collins Pre-Fab Kits easy to assemble even without technical knowledge. The end result is a fine, high quality, high fidelity instrument at often less than half the cost—because you helped make it AND BOUGHT IT DIRECT FROM THE FACTORY.

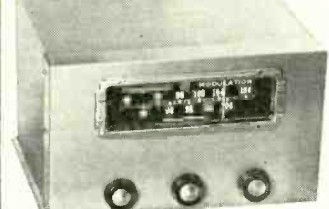

**NEW FM TUNER KIT**  
 New decorative gold front. New cascade front end—3 mv sensitivity. IF amplifier mounted, wired and tested in the chassis. You mount completed RF tuning unit and power supply. 11 tubes. 20 to 20,000 cycle response. A.F.C. and switch. Size: 12 1/2" x 9 1/2" x 7" high. Shipping weight: 15 pounds. Manual supplied. Gold screen cover available at \$3.50 extra. **PRICE: \$59.50**

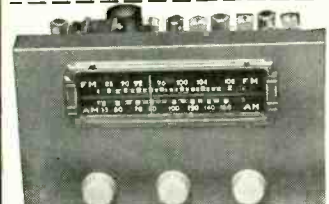

**NEW FM-AM TUNER KIT**  
 New, decorative gold front like FM tuner above. New cascade front end on FM—3 mv sensitivity. 15 tubes. Comprises chassis, power supply parts, AM unit, FM unit, IF amplifier, all wired and tested, ready for mounting in chassis. A.F.C. with switch. Kits include all parts and hardware. Size: 14" x 12" x 7 1/2" high. Shipping weight: 19 pounds. Manual supplied. Gold screen cover available at \$3.75 extra. **PRICE: \$82.50**

**FMF-3B Tuning Unit with Cascade**  
 Permeability tuned. 3 tubes. AFC. 3 microvolts sensitivity. May be used with any 10.7 MC IF amplifier such as our IF-6. **\$19.50**  
 2 pounds

**AM-4 Tuning Unit**  
 3-gang tuning condenser. Unit covers 530 to 1600 KC. Completely wired and tested with tubes. 4 tubes. Chassis plate measures: 4" x 7 3/8". 2 1/2 pounds. **\$24.50**

**IF-6 Amplifier**  
 6 tubes. 10.7 MC. Low distortion, high gain. 3 pounds. **\$21.50**

**MAIL COUPON TODAY!**  
 To: Collins Audio Products Co., Inc.  
 P. O. Box 368  
 Westfield, N. J. **RE-12**  
 Tel. Westfield 2-4390  
 FM Tuner Kit  FM-AM Tuner Kit  
 FMF-3B Tuning Unit  IF-6 Amplifier  
 AM-4 Tuning Unit  COVER

Name .....  
 Address .....  
 City ..... State.....  
 Amount for Kit \$.....  
 See weights, add shipping cost \$.....  
 Total amount enclosed \$.....  
 Check  Money Order

**WHEN YOU THINK OF TUNERS,**  
**THINK OF**  
**COLLINS AUDIO PRODUCTS**

**Books**

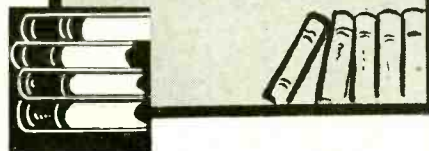

**SECOND THOUGHTS ON RADIO THEORY**, by "Cathode Ray." Published for *Wireless World* by Iliffe & Sons Ltd., London SE 1, England. 6 x 8 1/2 pages, 409 pages. 25 s.

For more than 20 years, "Cathode Ray" has written articles in the British magazine *Wireless World*, introducing the beginner to the mysteries of phase, harmonics, Q and cavity resonators, and the old-timer to equivalent circuits, duals, "j" and Thevenin's theorem, all in language that made the formerly incomprehensible look reasonable and in a style that made the reader want to understand.

A selection of the best of these articles (after revision and expansion where desirable) is now incorporated in a book so that the radioman can give a few "second thoughts" to things hurriedly "learned" but which he may now have a chance to understand for the first time. "Cathode Ray" also points out that he gives a few second thoughts to points "often missed out of even the big books."

The student will find *Second Thoughts* valuable for its different approach to subjects he has found hard to grasp; the instructor can study it as a guide to clear presentation and the technical author can well afford to read it for style alone.—FS

**AMPLIFICATION AND DISTRIBUTION OF SOUND**, 3d Edition, Revised, by A. E. Greenlees. Chapman & Hall, Ltd., 37 Essex St., London WC2, England. 5 1/2 x 8 1/2 inches, 300 pages. 35 s.

More useful information is contained in this volume than in many so-called "hi-fi" publications. It is written for the PA technician and theater sound man, but its clarity and completeness definitely recommend it to beginners as well.

Introductory chapters start with Ohm's law, decibels, power calculation. There is special emphasis on transformers, leakage inductance and capacitance effects at audio frequencies. Feedback, volume expansion and compression and performance measurements are described in the chapters on amplifiers and radio receivers. There are separate chapters on microphones, recording (optical, magnetic, disc) and loudspeakers. Necessarily some of this information is not too detailed, but all the fundamental principles are clearly explained.

Considerable space is given to the installation of sound equipment and the distribution of sound (including impedance matching). After reading these

**New! Low-Cost**  
**TUBE TESTER**

**with Plug-In Accessories**

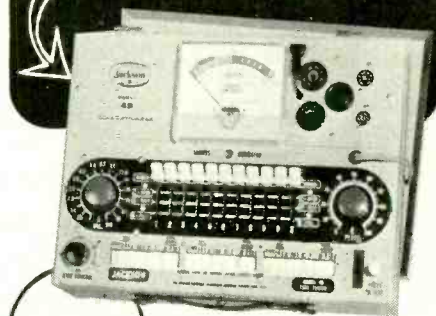

**\$49.95**

Accessories Extra

Model 49

**JACKSON**

*Automatic "Forty-Niner"*

Now One Meter and One Power Supply can be used for a wide variety of tests. You save money on the original tube tester—save even more on the many fine accessory testers. Tests all radio and TV tubes. Accessories provide additional tube checks plus testing of other components. Look at these features:

- Lever-Action Switches show which tube pins are connected or disconnected
- Big 5-Inch Meter
- Sensitive Shorts Test
- Airplane Fasteners for Plug-In accessories
- Line Voltage Indicator
- All-Steel Carrying Case

**These Plug-In Testers Now Available**



High-Resistance Shorts Check tests for interelement shorts up to 2,000,000 ohms. Almost ten times the sensitivity of average testers. Model 49N. **\$6.95 net.**

Filament Current Tester shows actual heater current drawn by tube. Three ranges to 5 amps. A must for series heaters. Model 49C **\$14.95 net.**

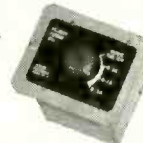

Selenium Rectifier Tester tests condition of power rectifiers. All sizes, 20 to 650 ma., 25 to 300 volts. Includes test leads. Model 49R **\$17.95 net.**



Plug-In Unit readies tester for any of the plug-in accessory testers. Includes 10-contact socket, already wired. Simple to install. Model P49-B. **\$2.95 net.**

Auxiliary Tube Socket Panel for testing older tubes and subminiatures. Includes parts for converting both socket panels to plug in use. Model 49S. **\$11.95 net.**

**More Accessory Testers Available Soon!**

**JACKSON**  
 ELECTRICAL INSTRUMENT CO.

"Service Engineered" Test Equipment  
 16-18 S. Patterson Boulevard, Dayton 2, Ohio  
 In Canada: The Canadian Marconi Company.

Easy  
as pie!



**HIGH FIDELITY  
ARKAY KITS  
LABORATORY  
TESTED**

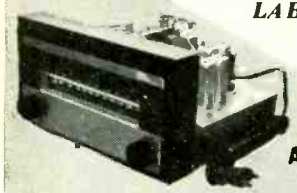

**Arkay FM-AM  
Tuner Kit**

7 tube circuit plus selenium rectifier includes separate mixer and Oscillator stages, 3 double tuned IF stages with Foster-Seeley discriminator and grounded grid amplifier for excellent response characteristics:

Sensitivity & Selectivity—FM 5µv for 30db quieting, 200 kc bandwidth 6db down. AM 25µv with 8 kc bandwidth 6db down.

Frequency Response —  
FM ±.5db 20-20,000 cps  
AM ±3db 20-5000 cps  
Image rejection —30db minimum  
Hum Level —-65db.

AFC control and defeat. **\$25.95**  
Available in FM only. Model FM6

**Arkay  
FL-10 High Fidelity  
Amplifier Pre-Amp Kit;**

Write for technical information on this model.

Unity coupled pushpull 12 watt output; frequency response ±2db 20-20,000 cps with extremely low IM and Harmonic distortion; 5 position input selector with record equalizer; loudness, bass, and treble controls; tapped output; extremely low noise level; completely enclosed—no cabinet problem; for clean, flexible, brilliant audio.



**\$28.95**

**Arkay A-12  
High Fidelity  
Amplifier Kit  
Featuring**

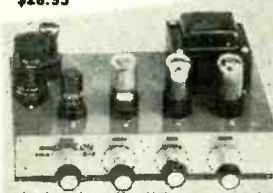

12 watt output—push pull 6V6's; frequency response ±1db 20-20,000 cps with low distortion; 5 inputs, master controlled at front panel; tapped output transformer; separate bass and treble control, each with maximum db boost and cut; built-in Pre-Amplifier; ideal for home installations.

**\$22.95**

**OTHER PRODUCTS  
IN THE ARKAY LINE OF KITS**

- Radios • Testing Equipment
- Experimenters Equipment
- Audio Amplifiers
- Phonographs
- Geiger Counters
- Television Kits

Visit your local distributor for these wonderful kits and write today for the special FREE Radio Kits Catalogue and list of dealers. Your copy will be sent by return mail with no obligation. Write to

**Radio Kits Inc., Dept. R-11  
120 Cedar Street New York**

BOOKS

(Continued)

chapters you will know how to match multiple speakers of different impedance and power ratings to a single source, how to arrange speakers and mikes for minimum echo, how to operate, maintain and test audio circuits and components.

Useful wire tables, a chart for matching speakers, filter design, are among the many topics found in the appendix.—IQ

**THE MOBILE MANUAL FOR RADIO AMATEURS (1st Edition), American Radio Relay League, West Hartford, Conn. 352 pages. \$2.50 in U. S. A., \$3 elsewhere.**

A compilation of over 80 carefully selected articles on mobile radio assembled from back issues of QST magazine, this is a valuable reference work and guide to construction, maintenance and operation of mobile radio equipment. Although prepared especially for amateurs, it will prove useful to designers, operators and technicians working with equipment on frequencies adjacent to amateur bands.

**ELECTRONICS FOR YOUNG PEOPLE, by Jeanne Bendick. Whittlesey House, McGraw-Hill Book Co., New York. 189 pages. \$2.75.**

For children 10 years of age and older, this is a new edition with an enlarged section on atomic energy. Written in easy-to-understand language, it introduces electronics, the atomic theory and nuclear energy and shows what they do for us and what we can reasonably expect from them in the future.

**DICTIONARY OF MECHANICAL ENGINEERING TERMS (7th Edition), by J. G. Horner. Philosophical Library, Inc., New York. 537 pages. \$6.50.**

The latest edition of a popular work compiled by the late J. G. Horner is revised and enlarged by Staton Abbey. Part I, "Modern Terms" (120 pages), covers terms not included in earlier editions. Part II, "General and Traditional Terms," has 417 pages.

**AUTOMATIC RECORD CHANGER SERVICE MANUAL WITH TAPE RECORDER SERVICE DATA (Vol. 6). Howard W. Sams & Co., Indianapolis, Ind. Pages not numbered. \$3.**

Sixth in a series, this is a compilation of Photofact folders covering approximately 20 late model tape recorders as well as about 8 automatic record changers.

**RIDER'S SPECIALIZED AUTO RADIO MANUAL (Vol. 6-A, Motorola). John F. Rider Publisher, New York. 208 pages. \$3.**

Reprints of factory-issued service and installation data on custom-built Motorola auto radios for all makes of cars from 1948 through 1955. END

**New Gift Suggestions at  
Special Holiday Low Prices**

Newest Phonographs! The Ideal Gift!

**3-Speed Portable Phonograph**

Plays all speed records (33 1/2, 45 & 78 RPM) with a new, all purpose permanent needle. Complete with excellent amplifier and speaker for unusual fine tone. Luggage type carrying case, durable and long lasting. 12 1/2" x 10" x 5 1/2", 8 1/2 lbs.



Unusual Value  
**\$14.75**  
Special

**AUTOMATIC RECORD PLAYER**



3-Speed, fully automatic phono with the latest VM record changer; twist dual-needle pickup arm, jamproof, intermix (plays 7", 10" & 12" records in same stack), heavy duty 6" speaker for finer fidelity sound. Sturdy, portable case covered with dul'out tu-tone material. 18" x 14 1/2" x 8 3/4"; 22 lbs. Model 1404.

Now only **\$39.75**

**AUTOMATIC RADIO-PHONO COMBINATION**

Same as above but in a combination that includes a well engineered, hi-powered, 5-tube superhet. radio of the latest circuit. Model 1405. **Terrific Values... \$49.75**

**3-SPEED  
AUTOMATIC  
RECORD  
CHANGER**



Limited quantity! Famous make automatic changer plays all 3 speeds (33 1/2, 45 & 78 RPM) and all size records (7", 10" & 12"), intermixes records of same speed. Automatic shut off after last record. 1955 model. **Reduced \$22.50 to**

**3-TUBE PHONO AMPLIFIER**



NOT A KIT  
An assembled unit ready for installation using tone and volume control and 6 ft. rubber cord (less tubes)..... **\$2.95**  
Lowest Price! **\$4.45**  
With complete set of tubes.....

**PHONO OSCILLATOR**

NEW SAVINGS! • NOT A KIT!  
Wireless phono oscillator transmits recording for crystal pickups or voice from carbon mike through radio without wires. Can also be used as an intercom by using PM speaker as mike. (less tubes)..... **\$2.95**  
With complete set of tubes..... **\$3.95**

Write today for FREE Catalog. All mdse. shipped F.O.B. New York City, prices subject to change without notice. Include 20% deposit with C.O.D.'s.

**EDLIE Electronics**

154 Greenwich St., New York 6, N.Y.  
DI 9-3143



# RADIO SCHOOL DIRECTORY

## GET INTO ELECTRONICS

You can enter this uncrowded, interesting field. Defense expansion, new developments demand trained specialists. Study all phases radio & electronics theory and practice: TV; FM; broadcasting; servicing; aviation; marine; police radio. 18-month course. Graduates in demand by major companies. I.I.S. or equivalent required. Begin Jan., March, June, Sept. Campus life. Write for catalog.  
**VALPARAISO TECHNICAL INSTITUTE**  
Dept. C Valparaiso, Ind.



## ELECTRONICS

Prepare for unlimited opportunities in electronics! B.S. degree in 27 months. Intensive, specialized courses. Math, electrical engineering, TV, advanced radio theory & design. Mod. labs. Low tuition. Self-help. Also Aeronautical, Chemical, Civil, Electrical, Mechanical Engineering. G.I. approved. Enter Dec., Mar., June, Sept. Catalog.  
**INDIANA TECHNICAL COLLEGE**  
1512 E. Washington Blvd., Fort Wayne 2, Ind.

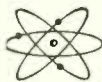

## RADAR

Our school is now introducing a correspondence course in Radar, Microwaves, and Loran. Get your FCC endorsement, high paying job in industry as a radar technician. Special introductory offer. Write

**PROGRESSIVE ELECTRONICS INSTITUTE**  
P.O. Box 27764 Los Angeles 27, Calif.

## LEARN TV SERVICING

Send for free 24-page illustrated booklet which tells you how to become a successful TV technician. America's leading TV servicing school offers you a specialized training program that omits non-essential math & design theory. You concentrate on radio & TV servicing only. You get professional training & experience right in our fully-equipped shops & laboratories. Write Dept. E-12-55  
Approved for Veterans

**WESTERN TELEVISION INSTITUTE**  
341 W. 18th St. Los Angeles 18, Calif.

## TV REPAIRMEN EARN TOP MONEY!



IN JUST 12 MONTHS, COMPLETE TV SERVICE TRAINING, INCLUDING COLOR TV. Streamlined course gives you all essentials for a good job as service technician. Graduates in great demand; jobs are plentiful in this growing field. Other electronic courses in radio operation and maintenance. Day or evening classes. Opportunity for employment in local industry. Approved for Korean veterans.

Write for Catalog 111 Today

**INDIANAPOLIS ELECTRONIC SCHOOL**  
312 E. Washington, Indianapolis 4, Ind.

### CODE SENDING RECEIVING SPEED

Be a "key" man. Learn how to send and receive messages in code by telegraph and radio. Commerce needs thousands of men for jobs. Good pay, adventure, interesting work. Learn at home quickly through famous Candler System. Quality for Amateur or Commercial License. Write for FREE BOOK.  
**CANDLER SYSTEM CO.**  
Dept. 3-O-Box 923, Denver 1, Colo., U.S.A.

## MORE JOBS than graduates

Demand for our engineering graduates exceeds supply. *Effective placement service.* Study in this world-famed college established 1884. Quarters start Jan., March, June, Sept. Approved for Veterans.

## Bach. Sc. degree in 27 months

Complete Radio Eng. course includes TV, UHF and FM. Also Mech., Civil, Elec., Chem., Aero. and Adm. Eng.; Bus. Adm., Acct. Small classes. Well-equipped labs. Modest costs. Prep. courses. Write *Jean McCarthy, Director of Admissions, for Catalog, View Book and "Your Career" Book.*

## TRI-STATE COLLEGE

24125 College Avenue, Angola, Indiana

## Get Your F.C.C. LICENSE Quickly!

Guaranteed preparation, in a MINIMUM OF TIME, for F.C.C. commercial operator examinations. Our highly specialized training is available by correspondence, or in resident classes in

WASHINGTON, D.C. and HOLLYWOOD, CALIF.

Write for our free booklet with complete details.

**GRANTHAM School of Electronics**

Dept. 2-Z, 737 11th Street S.W., Washington 1, D.C.

## TELEVISION

### PREPARE FOR A GOOD JOB!

BROADCAST ENGINEER  
ELECTRONICS  
RADIO SERVICING

### Television Servicing

(Approved for Veterans)

SEND FOR FREE LITERATURE

**BALTIMORE TECHNICAL INSTITUTE**  
1425 EUTAW PLACE, BALTIMORE 17, MD.

## LEARN TV

*'At the most practical school in the west'*

Work on late model sets—using modern equipment and service techniques: under qualified technician instructors. Short resident and correspondence courses—no unnecessary math or theory—also UHF and Color TV.  
APPROVED FOR VETERANS . . . day and nite classes.

Write for free literature, Dept. IA for residence—Dept. IAC for correspondence.

**V.S.I. TELEVISION SCHOOL**

4570 Firestone Blvd.  
South Gate, California

## PHOTOGRAPHS

RADIO-ELECTRONICS can use good photographs of service benches, service shops, high-fidelity audio layouts, and any other interesting and original radio-electronic devices.

We will pay \$6.00 each for good professional photos or equivalent, suitable for reproduction.

Full information on subject photographed will increase acceptability.

**The Editor, RADIO-ELECTRONICS**

25 West Broadway, New York 7, N.Y.

*Your choice of school is highly important to your career in*



**INDUSTRIAL ELECTRONICS**



**RADIO**



**TELEVISION**

*Become an ELECTRICAL ENGINEER or an ENGINEERING TECHNICIAN at*

## M.S.O.E. in Milwaukee

*Choose from courses in:*  
**ELECTRICAL ENGINEERING**  
*Bachelor of Science degree in 36 to 42 months with a major in electronics or electrical power.*

**ELECTRICAL TECHNOLOGY**  
*Engineering Technician certificate in 12 months in electronics, radio, or electrical power;*

*Associate in Applied Science degree in 18 months in radio and television.*

**TECHNICAL SERVICE**  
*Service certificate in 6 months in electricity; in 12 months in radio and television.*

**M.S.O.E.** — located in Milwaukee, one of America's largest industrial centers — is a national leader in electronics instruction — with complete facilities, including the latest laboratory equipment, visual aid theater, amateur radio transmitter — offers 93 subjects in electrical engineering, electronics, radio, television, electrical power, and electricity.

Advisory committee of leading industrialists. Courses approved for veterans. Over 50,000 former students. Excellent placement record.

TERMS OPEN JANUARY, APRIL, JULY, SEPTEMBER

*Choose wisely — your future depends on it. Write for more information today!*



**MILWAUKEE SCHOOL OF ENGINEERING**  
Dept. RE-1255, 1025 N. Milwaukee St.  
Milwaukee 1, Wisconsin

Send FREE career booklets on:  
 Electrical Engineering  Radio-Television

I am interested in..... (Name of course)

Name.....

Address.....

City..... Zone..... State.....

If veteran, give discharge date.....

MS-31

Only the 5 TOP QUALITY brands of

**STANDARD BRAND TUBES**

**AT SENSIBLE PRICES!**

All tubes are BRAND-NEW, factory-fresh TV stock. Each tube carries a dual guarantee. Standard factory RTMA guarantee and Barry's own guarantee of positive customer satisfaction. Be SAFE! Buy BARRY!

- Individually boxed ● First quality only
● Latest dating ● Standard RTMA guarantee
● No private brands ● No rejects
● No rebrands or rewashed bargains

FREE! Newest handy air-mail order form printed in carbon snap-out sets for your ordering convenience. Lists over 400 popular replacement types. Write for your free copy today!

- Lists ALL popular TV & radio types.
● Makes mail-ordering a real pleasure.
● All tube orders over \$25.00 (with remittance) postpaid. Overnight shipment.

**SPECIAL-PURPOSE TUBES**

Write for our complete listing on Transmitting, Industrial, Special-Purpose Tubes, and Crystal Diodes. We STOCK over 2000 types at excellent prices.

**INFRA-RED TUBES & PARTS**

SNOOPERSCOPE TUBE. Supersensitive. Converts invisible infra-red rays into a bright image. Sees in total darkness.

- Type CRI-143 } either type,
CRI-147 } SPECIAL \$3.95

INFRA-RED FILTER. Snap-on type. For extremely sharp images. SPECIAL EACH \$1.05

7MV HI-VOLTAGE CONVERTER. Miniature type. Capable of delivering 6000 VDC (low current). Operates from a single standard size flashlight cell. Includes circuit diagram & complete application instructions describing use in portable power supplies for snooper scopes, photo flash units, trigger counters, etc. NET EACH \$12.50

**SELSYN INDICATOR ASSEMBLIES**

110 volt, 60 cycle. Perfect trackers. Ideal for antenna rotation and direction indicator systems. May be used as light duty speed control speedometer. Completely enclosed in machined aluminum cases. Mounted on small chassis with 360° rotating dial face and pointer on front. Equipped with 2 bulb indicator light system complete with dimmer control and 6.3 volt step down transformer. Made by Bendix. Type XV, Cal-11900A, 78386. Used, but in guaranteed perfect condition. SPECIAL PER AIR MAIL \$9.75. QUANTITY LIMITED! (Net each \$5.00)... RACK PANELS for above. Standard size by 10 1/2" high. Metallic grey enameled finish. EACH \$1.25

**DIRECTRON SELENIUM RECTIFIERS**

Full Wave Bridge Type

Table with 5 columns: Max. Amps., 18VAC 14VDC, 36VAC 28VDC, 54VAC 42VDC, 72VAC 56VDC, 130VAC 100VDC. Rows show various amp ratings from 1 to 100.

**NEW RECTIFIER TRANSFORMERS**

Pr: 115V, 60 cycles input SEC: 9, 12, 18, 24, and 36 volts. Continuous. 1 Amp .....\$ 5.75, 2 Amps ..... 6.75, 3 Amps ..... 8.65, 4 Amps ..... 10.5, 5 Amps ..... 12.35, 6 Amps ..... 14.2, 8 Amps ..... 17.65, 10 Amps ..... 21.1, 12 Amps ..... 24.55, 15 Amps ..... 30.95, 20 Amps ..... 41.4, 25 Amps ..... 51.8, 30 Amps ..... 62.2, 35 Amps ..... 72.6, 40 Amps ..... 83.0, 50 Amps ..... 103.9, 60 Amps ..... 124.8, 70 Amps ..... 145.7, 80 Amps ..... 166.6, 100 Amps ..... 208.00

**NEW RECTIFIER CHOKES**

Continuous Ratings: 1 Amp .....1 Hy ..... 1.5 ohm .....\$ 4.95, 2 Amps ..... .04 Hy ..... 9 ohm ..... 5.95, 4 Amps ..... .07 Hy ..... 6 ohm ..... 7.95, 12 Amps ..... .01 Hy ..... 1 ohm ..... 14.95, 24 Amps ..... .004 Hy ..... .025 ohm ..... 29.95, 50 Amps ..... .005 Hy ..... .01 ohm ..... 54.00

**FILTER CAPACITORS**

Capacity 500 MFD .....\$ 1.00, 1000 MFD .....\$ .85. W. Voltage 15 V.

**2 COLOR TUBE CARTONS**

Keeps your tube stock neat. New safety partition prevents tube breakage. Distinctively lithographed in glossy red and black. The most distinctive tube carton available today. Minimum quantity: 100 of any one size. Write for case lot quantity prices.

SIZE FOR TUBE TYPES PER 100. Miniature (6AU6, 6AL5, etc.) .....\$1.00, GT (6SN7, 6W4, etc.) .....1.25, Large GT (1B3, 6BQ6GT, etc.) .....1.50, Large G (5U4G, 6BG6G, etc.) .....2.00

**NEW!**

White glossy boxes without printing (completely blank) otherwise same as above. Same high quality, same prices. Specify "White".

TERMS: 25% deposit with order, balance C.O.D. All merchandise guaranteed. F.O.B. N.Y.C.

**BARRY ELECTRONICS CORP.** Dept. RE 512 Broadway - N.Y. 12, N.Y. Phone: Walker 5-7000

**ADVERTISING INDEX**

Radio-Electronics does not assume responsibility for any errors appearing in the index below.

Index listing various companies and their page numbers: Airex Corp., Alliance Manufacturing Co., Allied Radio Corp., Almo Radio Co., American Phonic Corp., Arkay Radio Kits, Inc., Atlas Sound Corp., Audel, Publishers, Barjay Co., Barry Electronics, Belden Manufacturing Co., Bell Telephone Labs., Blonder-Tongue Labs., Brooks Radio & Television Corp., Burnstein-Appelbe, Co., Cabinart, Camp (J. Beidler) & Co., Capitol Radio Engineering Institute, CBS-Hytron, Central Electronics, Inc., Channel Master Corp., Chicago Standard Transformer Co., Cleveland Institute of Radio Electronics, Collins Audio Products, Cornell-Dubilier, Coyne Electrical & Television School, DeVry Technical Institute, Dyna Co., Edlie Electronics, Ekeradio Electronic Developments, Electro-Voice, Inc., Electronic Instrument Co. (EICO), Electronic Measurements Corp., Engineering Research Associates (ERA), E-Z Way Towers, Inc., Federal Telephone & Radio Co., Fenton Co., G. & H. Wood Products Co., General Cement Manufacturing Co., General Electronic Equipment Co., Gernsback Publications, Hawkins (P. E.) Co., Heath, Hershel, Hickok Electrical Instrument Co., Hudson Specialties Co., Hughes Research & Development Labs., I. B. M., Indiana Technical College, Instructograph Co., International Radio & Electronics Corp., Jackson Electrical Instrument Co., Jensen Industries, Jones & Laughlin Steel Corp., Klipsch & Associates, Lafayette Radio, Lektron Specialties, Leetone Radio Corp., LMB, Mallory (P. R.) & Co., Mallory (William J.), Miller (Gustave), Miller (J. W.) Co., Moss Electronics Distributing Co., National Radio Institute, National Schools, Newark Electric Co., Ohmite Manufacturing Co., Opportunity Adlets, ORRadio Industries, Pilot Radio Corp., Precise Development Corp., Precision Apparatus Co., Inc., Progressive Edu-Kits, Inc., Pyle, Ltd., Radiart Corp., Radio City Products, Radio Corp. of America (Test Equipment), Radio Corp. of America (Tube Division), Radio Products Co., Radio Receptor, Inc., Radium Technical Institute, Candler System Co., Grantham School, Indianapolis Electronic School, Milwaukee School of Engineering, Progressive Electronics Institute, RCA Institutes, Inc., Tri-State College, Valparaiso Technical Institute, V.S.I. Television School, Western Television Institute, Radio-Television Training Association, Rad-Tel, Rauland-Borg Corp., Raytheon Manufacturing Co., RCA Institutes, Inc., Rider (John F.), Inc., Rinehart Books, Inc., Rockbar Corp., Sams (Howard W.) & Co., Inc., Sangamo Electric Co., Shure Brothers, Inc., Simpson Electric Co., Sky-Ray Manufacturing Co., Sonotone Corp., Sprayberry Academy of Radio, Stan-Burn Radio & Electronics, Stanley Electronics Corp., Sylvania Electric Products, Inc., Tab, Techmaster Corp., Tele-Diagnosis Co., Telephone Engineering Co., Television Hardware Manufacturing Co., Telvac, Thompson Products Co., Transvision, Inc., Triad Transformer Corp., Triplet Electrical Instrument Co., Turner Sol Electric Co., Turrier Co., United Catalog Publishers, Universal Television School, University Loudspeakers, Utah Radio Products Co., Viking of Minneapolis, Wayco, Inc., Webster Electric Corp., Weller Electric Co., Weston Electrical Instrument Co., Wholesale Radio Parts, Winegard Co., Winston Electronics, Inc., Xcelite, Inc.

**TROLMASTER**

**CLEANS AND LUBRICATES TV-RADIO CONTROLS IN 60 SECONDS**



Now you can completely clean and lubricate volume, tone, brightness and contrast controls without removing chassis or back from cabinet. Simply remove knob at front of control, screw solvent-loaded TROLMASTER onto control, push the plunger in, remove TROLMASTER, work the control back and forth and the job is done—in 60 seconds or less! TROLMASTER thoroughly cleans either single or dual controls. Constructed of solid brass, TROLMASTER will not corrode when used with any chemical normally used in the electronics industry. User's Net, \$3.95

**KLENTROL MAGIC SOLVENT** Cleans, lubricates TV-Radio controls and tuner, push-button and switch contacts. Non-inflammatory. Will not harm surfaces or finishes of wood, metal or acetate. Recommended for use with TROLMASTER. Full Pint. User's Net, \$1.95 See your Distributor or write.

**R-COLUMBIA PRODUCTS CO., INC.** HIGHWOOD, ILLINOIS

Export Agents: COMTRAD CORP. 673 Broadway New York, N.Y. RADIO-ELECTRONICS

# LAFAYETTE leads the Field in TRANSISTORS Circuits Kits & Components

## TRANSISTOR TELEPHONE PICK-UP AMPLIFIER KIT TWO CAN LISTEN ON SAME PHONE CONVERSATION

With this ingenious kit you can build a tiny transistorized telephone pick-up amplifier, with which two people can listen in on telephone conversations without the need of an extension phone. Also serves as a high gain amplifier to feed into a tape recorder, for recording telephone conversations. Can also be used as a portable amplifier with crystal microphone and matching transformer when desired. The circuit utilizes a transformer coupled audio for high gain and two R.C. coupled stages. Kit comes complete with 3 Transistors, Transformer, Audio Transformer, Condensers, Resistors, etc., and Plastic Case. Size: 2 1/2" x 1 1/2" x 3 1/2", and batteries

**KT-76 Complete Kit (Less Earphones)..... Net 9.95**  
**MS-16 Telephone Pick-Up..... Net 2.95**  
**MS-111 Miniature Crystal Ear Receiver..... Net 1.49**  
**MS-260 New Super Power Dynamic Earphone..... Ideal for Transistor Circuits..... Net 3.95**



## 3 TRANSISTOR PUSH-PULL AUDIO AMPLIFIER FOR SPEAKER OPERATION

With the New Lafayette KT-69 Kit you can now build a self-powered, push-pull Class "A" transistor, audio amplifier for speaker operation, having a frequency response of 100-8000 cps. The Argonne Transistor transformers were especially designed for transistor circuits. Kit comes complete with 3 transistors, push-pull input and output transformers, battery holders, etc., schematic diagram.

**KT-69 Complete with batteries... Net 17.95**

## TWO TRANSISTOR PREAMP KIT

With the Lafayette KT-71 you can now build a simple Transistor preamp in a matter of hours. The overall result will be a noiseless, humless and virtually distortionless amplifier. The complete unit is mounted on an aluminum chassis size 3"x4"x1". The Kit comes complete with two transistors, condensers, resistors, battery holders, batteries, etc., and schematic diagram.

**KT-71 Complete Kit..... Net -8.95**

## 2 TRANSISTOR POCKET RADIO KIT

Packed into a 2 1/2" x 3 1/2" x 1 1/4" plastic case, this two transistor plus crystal diode radio kit offers many surprises, utilizing a regenerative detector circuit with transformer coupled audio stage, gives you high gain and excellent selectivity. Pulls in distant stations with ease with more than ample earphone volume. Kit comes complete with two transistors, crystal diode, loopstick, Argonne transistor audio transformer, resistors, condensers, plastic case, etc., including schematic and instructions.

**KT-68A Complete Kit less earphones..... Net..... 11.80**  
**MS-260 New Super Power Dynamic Earphone, Ideal for Transistor Circuit Imp. 8000 ohm, D.C. 2000 Ohm..... Net..... 3.95**

## LAFAYETTE GEIGER COUNTER KIT WITH HIGH SENSITIVITY VICTOREEN TUBE 1B85

Lafayette Geiger Counter Kit with High Sensitivity Victoreen 1B85 tube, makes this one of the most outstanding kit buys in the country. This tube is used only in the most expensive equipment. Easy to build, at only a fraction of the price of commercial instruments of this type. Just turn it on, flip the high voltage switch and listen to the clicks. Kit includes all parts, tube, carrying case, 22 1/2" and 1 1/2" Volt Batteries. Complete instructions for quick assembly.

Shpg. wt., 1 1/2 lbs.  
**KT-75..... Net 14.95**



### TRANSISTOR 455 KC I.F.

Specialized designed for transistor circuits, only 1 1/2" square by 3/4" high.

**MS-126**  
 In lots of 10, each 79¢  
 Single, Each 89¢

### RAYTHEON TRANSISTOR

TYPE CK722  
 P-N-P

**99¢**

## IMPORTED BINOCULARS

All have coated lenses - clamped in prisms - light weight all metal bodies. Complete with case and straps. Fully guaranteed for 6 mos. against mechanical and optical defects.

Includes Hard Pigskin case

F-182	6x.15 I.F.	NET 10.75
F-105	8x.35 I.F.	NET 17.95
F-183	7x.35 C.F.	NET 20.95
F-184	7x.35 C.F. Wide Angle	NET 21.50
F-185	7x.50 C.F.	NET 24.95
F-164	7x.50 C.F.	NET 24.95
F-117	10x.35 C.F.	NET 27.95
F-109	12x.50 C.F.	NET 31.50
F-118	18x.50 C.F.	NET 37.50
F-185	20x.50 C.F.	NET 37.50

**MONEY BACK GUARANTEE**  
 Add 10% Fed. Tax to Prices

## TELEPHONE PICKUP FOR RECORDING TELEPHONE CONVERSATIONS

Induction telephone pickup. Telephone conversations can now be picked up with no tapping of wires or special telephone circuits. Simply place the phone base, either cradle or upright type, on the pickup platform and connect the leads to the high impedance input of any medium gain audio amplifier, or directly to any tape disc or wire recorder.

**MS-18..... 2.95**

## SUPER POWER DYNAMIC EARPHONE

FOR TRANSISTOR CIRCUITS  
 SPECIAL HIGH OUTPUT FOR LOW POWER CIRCUITS

The answer to the problem of the low output inherent in transistor circuitry you'll be amazed at the difference in volume when you use this new dynamic earphone. Gives up to 3 times the volume of other dynamic earphones. G impedance 8000 ohms; DC resistance 2000 ohms. Comes complete with 3 ft. detachable plug-in cord.

**MS-260..... 3.95**

## WEBSTER • GARRARD • COLLARO 3-SPEED—HI-FI RECORD CHANGER

Now Lafayette makes it possible for you to save money on the three most popular makes of 3 speed Record changers.

**WEBCOR Diskchanger:** It's completely automatic, 33 1/3, 45 and 78 RPM, automatic shut off after last Record, balanced tone arm, etc. Size 13 1/2 x 12 x 8 1/4". Shpg. wt., 16 lbs.  
**Stock No. PK-49—With Dual Turnover Cartridge..... 24.95**  
**Stock No. PK-46—With G.E. RPX 050 Triple Play Cartridge..... 27.95**

**COLLARO, THE WORLD'S FINEST 3 SPEED INTERMIX CHANGER:**  
**Collaro Model 3/532—3 speed Intermix changer designed and engineered to meet the most exacting requirements of the finest audio systems. While our stocks last. Shpg. wt., 23 lbs. with G.E. RPX-050 Triple play..... Net 34.50**  
 With G.E. RPX-052A Triple play latest Golden Treasure cartridge with Diamond and Sapphire styl installed..... Net 44.95  
**Collaro RC-54:** Latest Collaro 3 speed Intermix less cartridge..... Net 49.95  
 With G.E. RPX-050 Triple play cartridge..... Net 59.95  
 With G.E. RPX-052A Triple play Golden Treasure cartridge with Diamond and Sapphire styl installed..... Net 48.51  
**Garrard Model RC-80 3 speed Record changer less cartridge..... Net 51.95**  
**Model RC-80 with G.E. RPX-050 Triple play Cartridge..... Net 51.95**  
**Model RC-80 with G.E. RPX-052—A latest triple play Golden Treasure cartridge with Diamond and Sapphire styl installed..... Net 62.53**



## TOP QUALITY CRYSTAL MICROPHONE

COMPARE IT WITH ANY MIKE AT 2 TO 3 TIMES THE PRICE

A quality crystal microphone for PA systems, house recorders, etc. Frequency response 30 to 10,000 cycles. Output level -52 db. Provides ample output for use with low gain amplifiers. Complete with 5 ft. of shielded cable. Shpg. wt., 3/2 lbs.

**PA-24** — in lots of 3 3.95 ea.  
 singly, each 4.25



## High Output Dynamic Microphone

List Price ~~\$47.00~~ **\$12.95**

High quality Dynamic microphone exceptionally fine for Public address recording, etc. Flat response 60-10,000 cps. Impedance 40,000 ohms at 1,000 cps, output level -55 db. Die cast metal case equipped with 6 ft. of shielded cable. Shpg. wt., 3 lbs.

**PA-19** — in lots of 3 12.45 ea.  
 singly, each 12.95



## Lafayette Greatest Tape Buy Ever!

1200 FT. REEL HIGH FIDELITY RECORDING TAPE  
 Shpg. wt. 14 oz.

LAFAYETTE made a terrific deal with one of the leading manufacturers of recording tape to supply us with their regular tape which sells for almost twice our price. WE GUARANTEE ABSOLUTE SATISFACTION OR YOUR MONEY BACK. The finest, professional-quality recording tape obtainable. Highest performance for thousands of playings. Red Oxide Base in a smooth, uniform coating; greater signal strength with maximum fidelity; uniform frequency response from 40-15,000 cps.

In lots of 10 rolls - **1.59 ea**

per roll plus postage (10% min.)

**1.69**



A new light weight Dynamic Ear Phone

Fits right into the ear. Excellent sensitivity of 65 db. Ideal for use with miniature sets, hearing aids, transistor pocket radios. DC resistance 2000 ohm, impedance 5000 ohm with 3 ft. of plastic cord.

**MS-72..... Net 1.95**  
**MS-100 Impedance 8 ohm for Silent Radio or TV viewing..... Net..... 1.95**  
**MS-108..... Net 1.95**

### MINIATURE CRYSTAL MICROPHONE

Here's a typical Lafayette special for the experimenter, student or dealer. An extremely sensitive and small crystal microphone used in hearing aids and other small apparatus. Can be used as a lapel mike—miniature transistor mike or concealed location, etc. Its size and performance gives it joint versatility. Brand new. Size only 1 1/8" diam, a 5/16" deep. Imported to save you money.

**MS-108..... Net 1.95**

## 5" Tweeter AND Crossover Network

A specially designed 5" Tweeter and Crossover Network that will assure high frequency response when used with any speaker you now possess. You can now make your present speaker into a 2-way speaker system increasing the high frequency range up to 15,000 cycles. Diagram included. Shpg. Wt. 5 lbs.

**STOCK NO. SY-14..... Net 7.95**



## 2.59 PRECISION DRAFTING SET

11 Pieces — Fitted Felt-Lined Case. Made in Germany of heavy brass, nickel plated and polished instruments, include 1 1/2" Compass with pencil and pen points and lengthening 3/4", Divider, 3 1/2" 38° side-wheel bow dividers with needle point, pen point and pencil point, 5" Ruling pen, extra handle for pen or pencil, capsule with extra leads. Your money back—if this set is not worth twice our price.

**F-13..... NET 2.59**

## 3 LENS TURRET MICROSCOPE

100X-200X-300X 4.95

Precision built for accuracy and long lasting service. Triple position turret holds 3 achromatic color-corrected objectives magnification of 100X, 200X and 300X power! Dual knob focusing! High-grade micro-objects using throughout. Complete with fitted wood carrying case and slides. Shpg. Wt. 4 1/2 lbs.

**F-10..... NET 4.95**



## DUAL STYLUS — TRIPLE PLAY DIAMOND and SAPPHIRE (LP) (73)

Replacement for All G.E. RPX-050 Triple-Play Cartridges!

**LIST \$34.00**

**11.95**

Stock No. PK-29..... Net 11.95



## TRANSISTOR TYPE 2N107

P-N-P **\$1.25**

## TIMER-SWITCH SALE 3.95

Automatically turns on radio, television sets, toasters, coffee makers, etc. — at any pre-set time within 12 hour period. Also tells time. Reutilizes 5/8" diameter round hole. Depth behind dial face 2 1/4". Shpg. wt. 1 1/2 lbs. MS-62, for 110V/60 Cy AC

send for FREE CATALOG

132 page electronic buying Guide, Transistors, radio, TV, Hi-Fidelity, Drafting supplies, microscopes, check full of buys at great savings. Write today for FREE COPY.

**Lafayette Radio** DEPT. JL  
 100 SIXTH AVE. PLAINFIELD, N.J. 139 West 2nd St.  
 NEW YORK, N.Y. BOSTON, MASS. 110 Federal St.  
 Include postage with order.



Now—at a big saving, you can easily

# BUILD YOUR OWN Electro-Voice® High-Fidelity SPEAKER ENCLOSURE

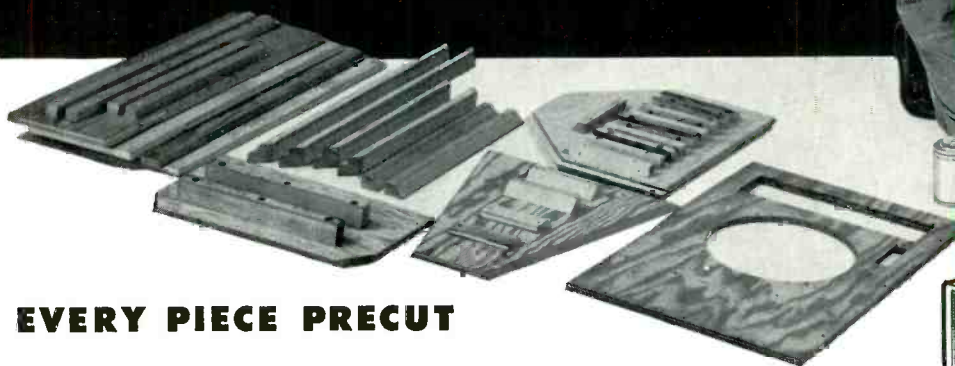

**EVERY PIECE PRECUT**

in *Ready-to-Assemble* **KITS**

Now you can have an acoustically correct Electro-Voice high-fidelity speaker enclosure for your home music system and *save up to one-half!* Build it yourself...seven models to choose from...wall types...corner types...for full range loudspeaker...for separate two, three and four-way speaker systems.

Every kit is completely ready for assembly, including glue, screws and nails. All parts are precut. Exterior surfaces are clear-grained birch—a hardwood that takes a beautiful furniture finish. These kits are so carefully engineered that simply by following the easy step-by-step instructions you can build an enclosure comparable to the renowned *Electro-Voice* factory-built enclosures.

Soft satin or high gloss furniture finish in walnut, mahogany, red mahogany, honey maple, golden oak or jet black is easily obtained by using an E-V Finishing Kit.\* The handles and metal trim from the appropriate E-V Decorative Trim Kit\* add the final touch for a smart, professional appearance. (\*Available separately.)

**THESE "DO-IT-YOURSELF" BOOKS SHOW YOU HOW TO BUILD IT**

*Included Free with Each Kit... or May Be Purchased Separately*



Each book gives complete, easy-to-follow, step-by-step instructions, diagrams, and photos. Makes it simple to build your Hi-Fi Speaker Enclosure with an E-V K-D Kit—or with your own materials purchased at your local lumber yard and hardware store. Get the book of your choice now from your nearest E-V High-Fidelity Distributor.

Model IB1—For Patrician	\$1.50
Model IB2—For Georgian	1.50
Model IB3—For Centurion	1.00
Model IB4—For Regency	1.00
Model IB5—For Empire	1.00
Model IB6—For Aristocrat	1.00
Model IB7—For Baronet	.75

See your E-V Hi-Fi Distributor—or write to Electro-Voice for complete information in Bulletin No. 211.

## Electro-Voice®

ELECTRO-VOICE, INC. • BUCHANAN, MICHIGAN  
Export: 13 E. 40th St., N.Y. 16, U.S.A. Cables: Arlab

**THE ARISTOCRAT KIT.** Folded-horn corner enclosure designed for 12-in. speakers and separate 2 and 3-way systems. For use with Electro-Voice SP12 or SP12B coaxial speakers, 12TRX or 12TRXB triaxial reproducers, and 108, 111 2-way and 108A, 111A 3-way systems. Smooth reproduction down to 35 cps, with remarkable purity and efficiency. Finished size: 29½ in. high, 19 in. wide, 15¼ in. deep. Shpg. wt. 37 lb.

Model KD5 Net, \$36.00

**THE BARONET KIT.** Phenomenal reproducer for such small size. This folded-horn corner enclosure is designed for use with E-V Model SP8B 8-in. Radax speaker. E-V T35 or T35B Super Sonax UHF driver can be added for a separate two-way system. Finished size: 23 in. high, 14 in. wide, 13 in. deep. Shpg. wt. 24 lb.

Model KD7 Net, \$24.00

**THE EMPIRE KIT.** Economical, folded-horn enclosure for use in a corner or flat against one wall. Designed for 15-in. speakers and separate 2 and 3-way systems. Particularly effective when used with SP15B coaxial speaker, 15TRXB triaxial reproducer, or 116 2-way or 116A 3-way system. Recommended components for Regency kit may also be employed. Finished size: 29½ in. high, 32 in. wide, 16 in. deep. Shpg. wt. 45 lb.

Model KD5 Net, \$48.00

**THE REGENCY KIT.** Most popular low-boy style folded-horn enclosure that can be used in corner or flat against one wall. Improves the bass range and response of any 15-in. speaker. Makes an outstandingly efficient reproducer when used with E-V SP15 coaxial speaker, 15TRX triaxial reproducer or 114A 2-way or 114B 3-way system. Finished size: 29½ in. high, 33½ in. wide, 19 in. deep. Shpg. wt. 70 lb.

Model KD4 Net, \$69.00

**THE PATRICIAN IV KIT.** An interior assembly kit for those desiring the finest. This augmented design of the Klipsch corner folded-horn bass section delivers an added full octave of bass. Designed for use with E-V Model 103C Patrician IV four-way driver components. For built-in installations or to be decorated as you choose. Finished size: 57½ in. high, 34½ in. wide, 26¾ in. deep. Shpg. wt. 150 lb.

Model KD1 Net, \$99.00

**THE GEORGIAN KIT.** An interior assembly kit that creates authentic Klipsch indirect radiator type corner folded-horn bass section for 15 in. 4-way speaker system. Exceeded in range only by the Patrician IV. For use with E-V Model 105 or Model 117 package of 4-way driver components. For built-in installations or to be decorated as you choose. Finished size: 38½ in. high, 26¾ in. wide, 22½ in. deep. Shpg. wt. 88 lb.

Model KD2 Net, \$58.00

**THE CENTURION KIT.** Four-way system folded-horn, corner enclosure. Uses exclusive E-V "W" type single-path indirect radiator for propagation of extended bass. Sealed cavity behind 15 in. low-frequency driver cone promotes superlative transient response, subdues cone excursions, lowers distortion. For use with E-V Model 105 or Model 117 package of driver components. Finished size: 42½ in. high, 29 in. wide, 22½ in. deep. Shpg. wt. 75 lb.

Model KD3 Net, \$79.00

# How to sweeten a sour video amplifier . . .

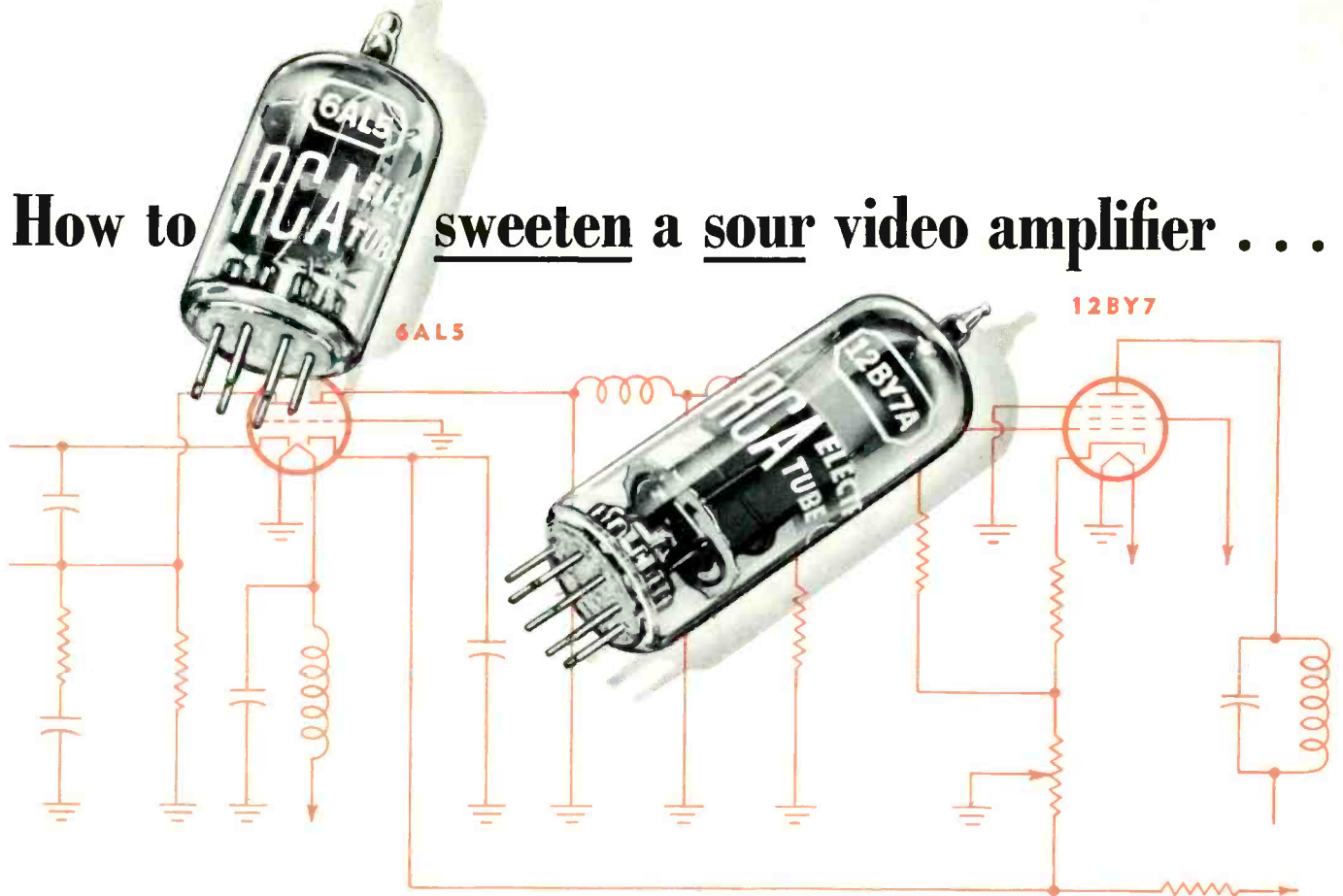

## Use RCA Tubes with Built-In Quality!

In 2nd picture detectors and video amplifiers, a "sour" 12BY7-A or 6AL5 can wash out or smear a picture and make a.g.c. ineffective. In video amplifiers with critical requirements, fine performance depends on good tubes in the sockets. Strict quality control and selected materials used in the manufacture of RCA tubes give you replacement tubes conforming to TV set manufacturers' requirements for top performance—your assurance of better picture and sound fidelity.

In circuits so vital to clear, sharp pictures—use only long-lasting top-quality tubes—that means RCA TUBES. Your customers will see and hear the differences.



**RADIO CORPORATION of AMERICA**  
ELECTRON TUBES  
HARRISON, N.J.

First choice for TV circuits . . . dependable RCA Tubes.

# ADV Plans, LLC

## Copyright Notice:

The entire contents of this CD/DVD are copyright 2014 by ADV Plans, LLC. All Rights Reserved.

Reproduction or distribution of this disk, either free or for a fee is strictly prohibited. We actively monitor and remove listings on eBay thru Vero.

You are free to copy or use individual images in your own projects, magazines, brochures or other school projects.

Only the sellers listed here are authorized distributors of this collection:  
[www.theclassicarchives.com/authorizedsuppliers](http://www.theclassicarchives.com/authorizedsuppliers)

Please view our other products at  
[www.theclassicarchives.com](http://www.theclassicarchives.com),  
or our ebay stores:

[TheClassicArchives](#)  
[ADVPlans](#)  
[SuperShedPlans](#)

